



User's Guide



Multimedia Projector

EB-G7905U	EB-G7000W
EB-G7900U	EB-G7805
EB-G7500U	EB-G7800
EB-G7400U	EB-G7100
EB-G7200W	





Notations Used in This Guide

- **Safety indications**

The documentation and the projector use graphical symbols to show how to use the projector safely. Please understand and respect these caution symbols in order to avoid injury to persons or property.

 Warning	This symbol indicates information that, if ignored, could possibly result in personal injury or even death due to incorrect handling.
 Caution	This symbol indicates information that, if ignored, could possibly result in personal injury or physical damage due to incorrect handling.

- **General information indications**

Attention	Indicates procedures which may result in damage or injury if sufficient care is not taken.
	Indicates additional information and points which may be useful to know regarding a topic.
	Indicates a page where detailed information regarding a topic can be found.
	Indicates that an explanation of the underlined word or words in front of this symbol appears in the glossary of terms. See the "Glossary" section of the "Appendix".  "Glossary" p.245
[Name]	Indicates the name of the buttons on the remote control or the control panel. Example: [Esc] button
Menu Name	Indicates Configuration menu items. Example: Select Brightness from Image . Image - Brightness

Make sure you read the following before you use the projector.

☛ [Safety Instructions](#)

Warning and Cautions on Installation

An optional ceiling mount is required when suspending the projector from a ceiling.

☛ "Optional Accessories" [p.215](#)

Warning

- Do not use or install the projector where it may be subject to water or rain, or high humidity, such as outdoors, in a bathroom, or shower room, and so on. Otherwise, it could cause a fire or electric shock.
- A special method of installation is required when suspending the projector from a ceiling (ceiling mount). If installation work is not carried out correctly, the projector could fall down. This may result in injury or accidents. Contact your local dealer or the nearest address provided in the Epson Projector Contact List.
☛ [Epson Projector Contact List](#)
- If you use adhesives on the ceiling mount fixing points to prevent the screws from loosening, or if you use things such as lubricants or oils on the projector, the projector case may crack causing it to fall from its ceiling mount. This could cause an accident or injury to anyone under the ceiling mount.
When installing or adjusting the ceiling mount, do not use adhesives to prevent the screws from loosening and do not use oils or lubricants and so on.
- Do not cover the projector's air intake vent or air exhaust vent. If either of the vents are covered, the internal temperature could rise and cause a fire.
- Do not place flammable objects in front of the lens. If you set the schedule to turn on the projector automatically, any flammable objects placed in front of the lens could cause a fire.
- Do not tie the power cord and other connection cables together. Otherwise, it could cause a fire.
- Only use the specified power-supply voltage. Otherwise, it could cause a fire or electric shock.

Warning

- Be careful when handling the power cord. Otherwise, it could cause a fire or electric shock. Note the following when handling the power cord.
 - Do not plug multiple power cords in a single electric outlet.
 - Do not plug in the power cord if there are any foreign substances, such as dust, stuck to it.
 - Make sure you insert the power cord all the way in.
 - Do not plug in or unplug the power cord with wet hands.
 - Do not pull the cord when unplugging the power cord. Make sure you hold it by the plug.
- Do not use a damaged power cord. Otherwise, it could cause a fire or electric shock. Note the following when handling the power cord.
 - Do not alter the power cord.
 - Do not place any heavy objects on the power cord.
 - Do not bend, twist, or pull the power cord forcibly.
 - Do not layout the power cord near a heating device.

Caution

Do not place the projector on an unstable surface, such as on an unstable table or tilted surface. When projecting vertically, install the projector appropriately to prevent the projector from falling. Otherwise it may cause an injury.

Attention

- Do not install the projector in a location that is subject to vibration or shock.
- Do not install the projector near a high-voltage line or object that generates magnetism. Otherwise the projector may not work correctly.
- Do not use or store the projector in a location that is subject to extreme temperatures. Also, avoid sudden temperature changes.
Make sure you use or store the projector in a place that is within the following operating or storage temperature ranges.
 - Operating temperature range
 - 0 to +45°C (Altitude of 0 to 1,500 m, no condensation)
 - 0 to +40°C (Altitude of 1,501 to 3,048 m, no condensation)
 - 0 to +35°C (Altitude of 3,049 to 5,000 m, no condensation)
 - Storage temperature range: -10 to +60°C (No condensation)
- When using at an altitude that exceeds 1,500 m, set **High Altitude Mode** to **On**.
 - ☛ **Extended - Operation - High Altitude Mode** [p.140](#)

Attention

- When projecting with the projector tilted, do not tilt it at more than the specified angle. This may cause malfunctions or accidents to occur.

Angle of tilt

Vertical: Can be installed at any angle in a complete 360 degrees.

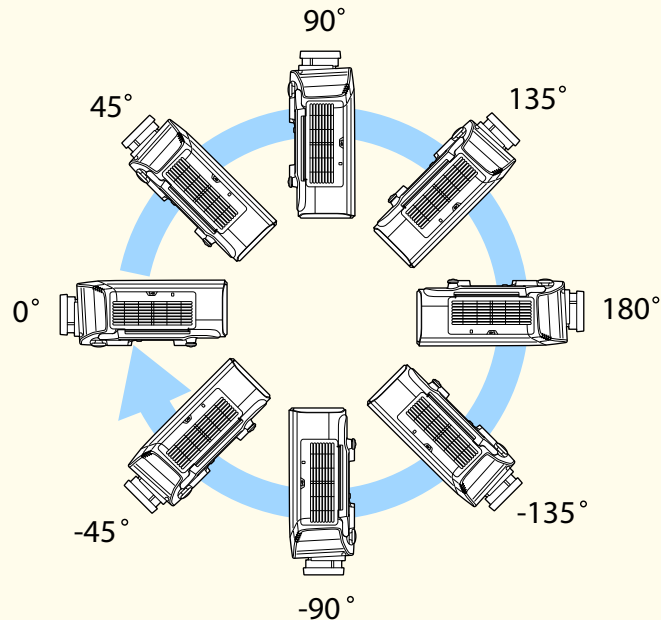

Horizontal: Tilt $\pm 10^\circ$.

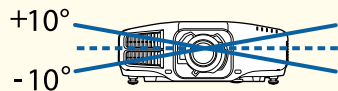

- Once installation is complete, make sure you set the **Direction**. If it is not set, the projector does not cool down correctly, and the lamps may deteriorate.
 - ☛ "Setting the direction" [p.28](#)
- Using the projector at an improper angle or setting the Configuration menu incorrectly causes malfunctions and shortens the operating life of optical parts.

Attention

- Make sure there is a gap as shown in the following illustration between the wall and the air exhaust vent and the air intake vent.

Air exhaust vent

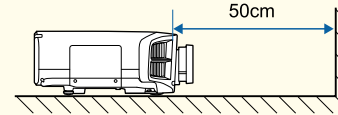

Air intake vent

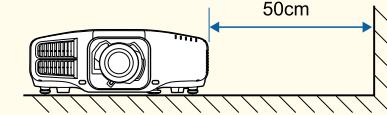

- When setting up multiple projectors, make sure there is a gap of at least 50 cm between the projectors. Also, make sure that the heat from the air exhaust vent does not go into the air intake vent.

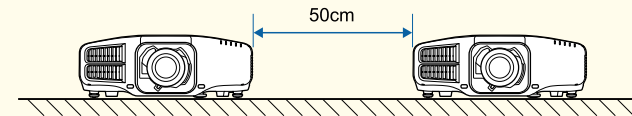

- Do not place the projector directly on top of another projector.

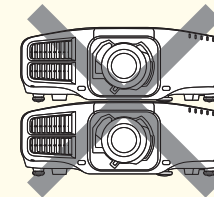

- We recommend setting the focus, zoom, and lens shift at least 20 minutes after you start the projection, because images are not stable right after turning on the projector.
- When adjusting the image height with the vertical lens shift, adjust by moving the image from the bottom to the top. If it is adjusted from the top to the bottom, the image position may move down slightly after adjusting.

Notes on portrait installation

A dedicated mount is required for portrait installation. Contact a professional and prepare the mount.

Attention

- Plan so that the mount does not fall.
- Use commercially available M6 screws (up to a depth of 12 mm) to fix the ceiling mount fixing points of the projector and the mount at four points (you do not need to remove the feet of the projector).

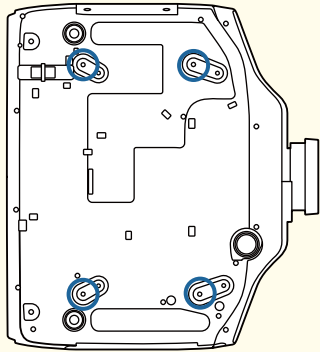

Attention

- Make sure you install the projector with the air intake vent facing down. If the air intake vent is facing up, the projector does not cool down correctly, and it may cause a malfunction.

Angle of tilt

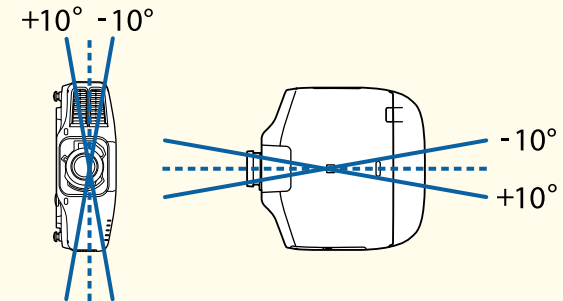

Using the projector at angles not shown in the illustrations above may damage it or cause an accident.

- Make sure that you install the projector with the air intake vent facing down and that there is a gap at least as wide as shown in the following illustration between the projector and the floor and so on. Make sure there is a gap of 400 x 200 mm for the base so that the air intake vent is not blocked.

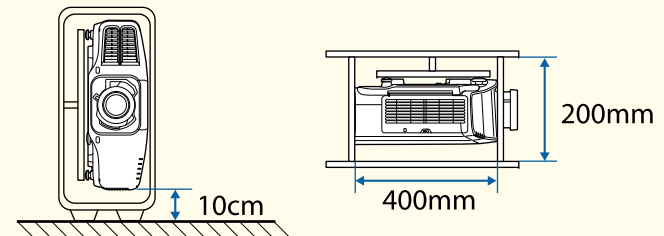

- Once installation is complete, make sure you set the **Direction**. If it is not set, the projector does not cool down correctly, and the lamps may deteriorate.
 - ☛ "Setting the direction" [p.28](#)
- Do not use lamps that have been used for about 2000 hours or more at normal installment. This may cause the projector to malfunction or cause the lamps to deteriorate.

Warning and Cautions on Usage

Warning

- Do not cover the projector's air intake vent or air exhaust vent. If either of the vents is covered, the internal temperature could rise and cause a fire.
- Do not look into the lens while projecting.
- During projection, do not block the light from the projector with the lens cover (removable) or a book and so on.

If the light from the projector is blocked, the area on which the light shines becomes hot which could cause it to melt, burn, or start a fire. Also, the lens may get hot due to the reflected light which could cause the projector to malfunction. To stop projection, use the A/V Mute function, or turn off the projector.

- A mercury lamp with high internal pressure is used as the projector's light source. If the lamp is subjected to vibrations, shocks, or if it is used for an overly extended length of time, the lamp may break or it may not turn on. If the lamp explodes, gases may escape and small fragments of glass may be scattered which could cause an injury. Be sure to observe the instructions below.
 - Do not disassemble or damage the lamp or subject it to any impacts.
 - Do not bring your face close to the projector while it is in use.
 - Particular care should be taken when the projector is installed to a ceiling, as small pieces of glass may fall down when the lamp cover is removed.When cleaning the projector or replacing the lamp yourself, be very careful not to allow such pieces of glass to get into the eyes or mouth.

If the lamp breaks, ventilate the area immediately, and contact a doctor if any fragments of broken glass are inhaled or get into the eyes or mouth. In addition, consult your local regulations regarding proper disposal and do not place in the trash.

Caution

Do not place objects that may become warped or otherwise affected by heat near the air exhaust vent and do not put your face or hands near the vent while projection is in progress.

Attention

- Do not repeatedly turn off the power and immediately back on. Turning the power on and off frequently may shorten the lamp's operating life.
- Only remove the lens unit when necessary. If dust or dirt enter the projector, projection quality deteriorates and it could cause a malfunction.
- Try not to touch the lens section with your hand or fingers. If fingerprints or oils are left on the surface of the lens, projection quality deteriorates.
- Store the projector with the lens unit installed.
If the projector is stored without the lens unit, dust and dirt may get inside the projector and cause malfunctions or lower the quality of projection.
- When storing, make sure you remove the batteries from the remote control. If the batteries are left in the remote control for an extended period of time, they may leak.

Notes on Transporting

There are many glass parts and precision components inside the projector. To prevent damage due to impacts when transporting, handle the projector as follows.



Caution

Do not carry the projector by one person. Two people are needed to unpack or carry the projector.

Attention

- Moving Nearby
 - Turn off the power to the projector and disconnect all cables.
 - Attach the cover to the lens.

- When Transporting

After checking the points in "Moving Nearby", prepare the following and then pack up the projector.

 - Remove the lens unit if an option lens is installed.
 - If the projector does not have a lens, attach the cover that was on the lens mount when you purchased the projector.
 - Attach the lens if the projector has a built-in lens. Upon purchase, attach the protective pad that is attached around the lens unit.
 - Move the lens position to the home position.
 - ☛ "Adjusting the Position of the Projected Image (Lens Shift)"
[p.33](#)
 - Enclose the projector securely in packaging material to protect it from shock, and place it into a strong cardboard container. Be sure to notify the carrier company that it is precision equipment.



Notations Used in This Guide 2

Introduction

Part Names and Functions 14

Front/Top	14
Rear	15
Interface	16
Base	17
Control Panel	17
Remote Control	19
Replacing the remote control batteries	22
Remote control operating range	23
Connecting a Cable to the Remote Control	24

Preparing the Projector

Installing the Projector 26

Removing and Attaching the Projector Lens Unit	26
Attaching	26
Lens Calibration	27
Removing	28
Installation Settings	28
Setting the direction	28
Changing the direction of the image (projection mode)	29
Projecting in a portrait installation	30
Screen Settings	30
Adjusting the position of the image on the projected screen	31
Displaying a Test Pattern	32
Adjusting the Position of the Projected Image (Lens Shift)	33
Adjusting the Image Size	36
Correcting the Focus	37
Correcting Distortion (Image Warping)	38
Registering and Loading Lens Adjustment Values	39
Adjusting the Height of the Projected Image (for Normal Installment)	40

Adjusting the Horizontal Tilt (for Normal Installment)	41
ID Settings	41
Set the projector ID	41
Checking the projector ID	42
Setting the remote control ID	42
Setting the Time	43
Other Settings	44
Settings related to basic operations	44
Settings related to display	45

Connecting Equipment 46

Connecting a Computer	46
Connecting Image Sources	48
Connecting External Equipment	49
Connecting a LAN Cable	50
Connecting an HDBaseT Transmitter	51
Installing the Wireless LAN Unit	52
Using the Quick Wireless Connection USB Key	53
Attaching the Cable Cover	53
Attaching	54

Basic Usage

Turning On the Projector 56

Home screen	57
-------------------	----

Turning Off the Projector 58

Projecting Images 59

Automatically Detecting Input Signals and Changing the Projected Image (Source Search)	59
Switching to the Target Image by Remote Control	60
Adjusting the Volume	61

Adjusting Projected Images 62

Correcting Distortion in the Projected Image	62
H/V-Keystone	63
Quick Corner	64

Curved Surface	65
Corner Wall	75
Point Correction	84
Selecting the Projection Quality (Selecting Color Mode)	86
Setting Auto Iris	87
Changing the Aspect Ratio of the Projected Image	87
Changing methods	87
Adjusting the Image	90
Hue, Saturation, and Brightness adjustment	90
Gamma adjustment	91
Frame Interpolation	94
Adjusting Image Resolution (Image Enhancement)	95
4K Enhancement (EB-G7900U/EB-G7400U only)	96
Image Preset Mode	97
Noise Reduction	97
MPEG Noise Reduction	97
Super-resolution	98
Detail Enhancement	98
Projecting 3D images	99

Hiding the Image and Sound Temporarily (A/V Mute)	117
Freezing the Image (Freeze)	118
Enlarging Part of the Image (E-Zoom)	118
Saving a User's Logo	119

Memory Function 121

Saving/Loading/Erasing/Resetting the Memory	121
---	-----

Scheduling Function 123

Saving a Schedule	123
Setting a schedule	123
Checking a schedule	124
Editing a schedule	124

Security Functions 126

Managing Users (Password Protection)	126
Kinds of Password Protection	126
Setting Password Protection	126
Entering the password	127
Restricting Operation	128
Control Panel Lock	128
Lens Lock	129
Remote control button lock	129
Anti-Theft Lock	130
Installing the wire lock	130

Useful Functions

Multi-Projection Function 101

Preparation	101
Edge Blending	101
Adjust the Edges of the Images (Edge Blending)	102
Correcting the Brightness (EB-G7900U/EB-G7200W/EB-G7000W/EB-G7800 only)	104
Fine-tuning the color balance	105
Tiling	110
Displaying a Scaled Image	111

Projection Functions 114

Projecting Two Images Simultaneously (Split Screen)	114
Input Sources for Split Screen Projection	114
Operating procedures	115
Restrictions during split screen projection	117

Configuration Menu

Using the Configuration Menu 132

List of Functions 133

Configuration Menu Table	133
Network menu	134
Image Menu	135
Signal Menu	137
Settings Menu	138
Extended Menu	140
Network Menu	145



Notes on operating the Network menu 146

Soft keyboard operations 146

Basic menu 147

Wireless LAN menu 147

Wired LAN menu 150

Notification menu 150

Others menu 151

Reset menu 152

Info Menu (Display Only) 152

Reset Menu 153

Batch Setup 154

Setup Using a USB Flash Drive 154

 Saving settings to the USB flash drive 154

 Reflecting saved settings to other projectors 156

Setup by Connecting the Computer and Projector with a USB Cable 158

 Saving settings to a computer 158

 Reflecting saved settings to other projectors 159

When Setup Fails 160

Troubleshooting

Using the Help 162

Reading the Indicators 164

Reading the Status Information 170

 Explanations of the Display Content 171

Problem Solving 177

Problems Relating to Images 178

 No images appear 178

 Moving images are not displayed 178

 Projection stops automatically 179

 Not supported is displayed 179

 No Signal is displayed 179

 Images are fuzzy, out of focus, or distorted 180

 Interference or distortion appear in images 180

 The image is truncated (large) or small, the aspect is not suitable, or the image has been reversed 181

 Image colors are not right 182

 Images appear dark 182

Problems when Projection Starts 183

 The projector does not turn on 183

Other Problems 184

 No sound can be heard or the sound is faint 184

 The remote control does not work 184

 Nothing appears on the external monitor 185

 I want to change the language for messages and menus 186

 Email is not received even if a problem occurs in the projector 186

 The battery that saves your clock settings is running low. is displayed 186

About Event ID 187

Maintenance

Cleaning 189

 Cleaning the Projector's Surface 189

 Cleaning the Lens 189

 Cleaning the Air Filter 189

 Cleaning the air filter 189

Replacing Consumables 192

 Replacing the Lamp 192

 Lamp replacement period 192

 How to replace the lamp 192

 Resetting the lamp hours 195

 Replacing the Air Filter 195

 Air filter replacement period 195

 How to replace the air filter 195

Image Maintenance 197

 Panel Alignment 197

 Color Uniformity 198

Appendix

Monitoring and Controlling 202

About EasyMP Monitor	202
About Message Broadcasting	202
Changing Settings Using a Web Browser (Epson Web Control)	202
Displaying the Epson Web Control Screen	202
Basic Control Screen	203
OSD Control Pad Screen	204
Lens Control Screen	204
Status Information Screen	206
Using the Mail Notification Function to Report Problems	207
Reading error notification mail	207
Management Using SNMP	208
ESC/VP21 Commands	208
Command list	208
Cable layouts	209
About PLink	210
About Crestron RoomView®	210
Operating a projector from your computer	211

Optional Accessories and Consumables 215

Optional Accessories	215
Consumables	216

Screen Size and Projection Distance 217

Projection Distance for EB-G7900U/EB-G7400U/EB-G7200W/EB-G7000W	217
ELPLM08	217
ELPLX01	218
ELPLU03	218
ELPLU04/ELPLU02	219
ELPLW05	220
ELPLW06/ELPLW04	220
ELPLM09/ELPLS04	221
ELPLM10/ELPLM06	222
ELPLM11/ELPLM07	223
ELPLL08/ELPLL07	224
ELPLR04	225

Projection Distance for EB-G7800	226
ELPLM08	226
ELPLX01	227
ELPLU03	227
ELPLU04/ELPLU02	228
ELPLW05	229
ELPLW06/ELPLW04	229
ELPLM09/ELPLS04	230
ELPLM10/ELPLM06	231
ELPLM11/ELPLM07	232
ELPLL08/ELPLL07	233
ELPLR04	234
Polarizer (ELPPL01) Installation Distance	235
EB-G7905U/EB-G7900U/EB-G7500U/EB-G7400U	235
EB-G7200W/EB-G7000W	235
EB-G7805/EB-G7800/EB-G7100	235

Supported Monitor Displays 237

Supported Resolutions	237
Computer signals (analog RGB)	237
Component Video	237
Input signal from the DVI-D port, HDMI port, and HDBaseT port	237

Specifications 239

Projector General Specifications	239
--	-----

Appearance 243

Glossary 245

General Notes 247

About Notations	247
Trademarks and Copyrights	248

List of Safety Symbols Compliant with IEC60950-1 A2 249

Index 251



Introduction

This chapter explains the names for each part.

The illustrations in this guide are for EB-G7900U (with the zoom lens ELPLM08 attached).

Front/Top

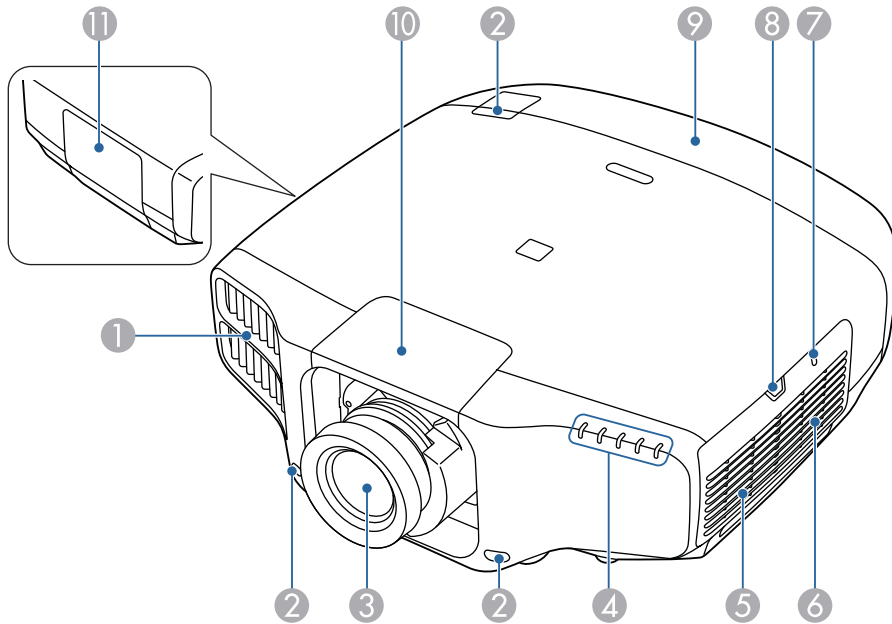

	Name	Function
①	Air exhaust vent	Exhaust vent for air used to cool the projector internally. <div data-bbox="1534 359 2094 614" style="border: 1px solid black; padding: 5px;"> <p>⚠ Warning</p> <p>Do not look into the vents. If the lamp explodes, gases may escape and small fragments of glass may be scattered which could cause an injury. Contact a doctor if any fragments of broken glass are inhaled or get into the eyes or mouth.</p> </div> <div data-bbox="1534 662 2094 917" style="border: 1px solid black; padding: 5px;"> <p>⚠ Caution</p> <p>While projecting, do not put your face or hands near the air exhaust vent, and do not place objects that may become warped or damaged by heat near the vent. Hot air from the air exhaust vent could cause burns, warping, or accidents to occur.</p> </div>
②	Remote receiver	Receives signals from the remote control.
③	Projection lens	Images are projected through here. <div data-bbox="1534 1029 2094 1252" style="border: 1px solid black; padding: 5px;"> <p>⚠ Caution</p> <p>When shifting the lens, do not put your hands near the lens unit. Your fingers may get caught between the lens unit and the projector, and cause an injury.</p> </div>
④	Status indicators	The color of the indicators and whether they are flashing or lit indicate the status of the projector. ☛ "Reading the Indicators" p.164
⑤	Speaker	Outputs audio.
⑥	Air intake vent (air filter)	Takes in air to cool the projector internally. ☛ "Cleaning the Air Filter" p.189

Name	Function
7 Wireless LAN indicator	Indicates the access status to the optional wireless LAN unit. ☛ "Optional Accessories" p.215
8 Air filter cover operation knob	Use this knob to open the air filter cover. ☛ "Replacing the Air Filter" p.195
9 Cable cover	Cover for the rear interface cable connection section. ☛ "Attaching the Cable Cover" p.53
10 Lens replacement cover	Remove when attaching or removing the lens. ☛ "Removing and Attaching the Projector Lens Unit" p.26 <div style="border: 1px solid black; padding: 5px; margin-top: 10px;"> <p>⚠ Caution</p> <p>When moving the projector, do not hold the lens replacement cover. The lens replacement cover may be removed and the projector may fall, which could cause an injury.</p> </div>
11 Lamp cover	Open when replacing the projector's lamp. ☛ "Replacing the Lamp" p.192

Rear

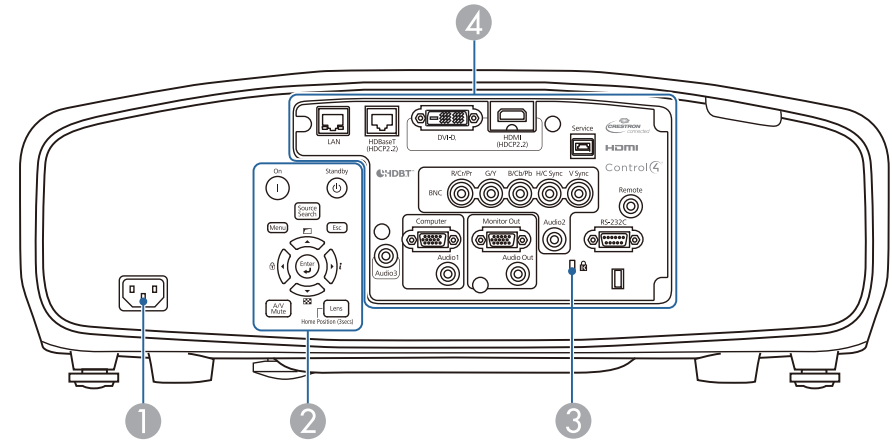

Name	Function
1 Power inlet	Connects the power cord to the projector.
2 Control panel	☛ "Control Panel" p.17
3 Security slot	The security slot is compatible with the Microsaver Security System manufactured by Kensington. ☛ "Anti-Theft Lock" p.130
4 Interface	☛ "Interface" p.16

Interface

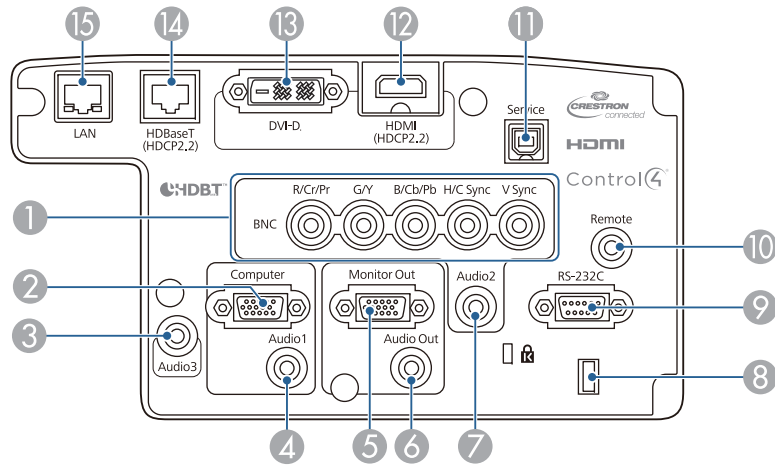

Name	Function
① BNC port	For analog RGB signals from a computer and component video signals from other video sources.
② Computer port	For analog RGB signals from a computer and component video signals from other video sources.
③ Audio3 port	Inputs audio from equipment connected to the HDMI port or the DVI-D port.
④ Audio1 port	Inputs audio from equipment connected to the Computer port.
⑤ Monitor Out port	Outputs to an external monitor the analog signal from the computer connected to the Computer port or the BNC port. You cannot output signals input from other ports or component video signals.
⑥ Audio Out port	Outputs audio from the currently projected image to an external speaker.
⑦ Audio2 port	Inputs audio from equipment connected to the BNC port.
⑧ Cable holder	Run a commercially available cable tie to secure cables.

Name	Function
⑨ RS-232C port	When controlling the projector from a computer, connect it to the computer with an RS-232C cable. This port is for control use and should not normally be used. ☛ "ESC/VP21 Commands" p.208
⑩ Remote port	Connects the optional remote control cable set and inputs signals from the remote control. When the remote control cable is plugged into the Remote port, the remote receiver on the projector is disabled. ☛ "Optional Accessories" p.215
⑪ Service port	This port is used by maintenance personnel to control the projector. This should not normally be used.
⑫ HDMI port	Inputs video signals from HDMI compatible video equipment and computers.
⑬ DVI-D port	Inputs the computer DVI-D signals.
⑭ HDBaseT port	Connects a LAN cable to the optional HDBaseT Transmitter. ☛ "Connecting an HDBaseT Transmitter" p.51 ☛ "Optional Accessories" p.215
⑮ LAN port	Connects a LAN cable to connect to a network.

Base

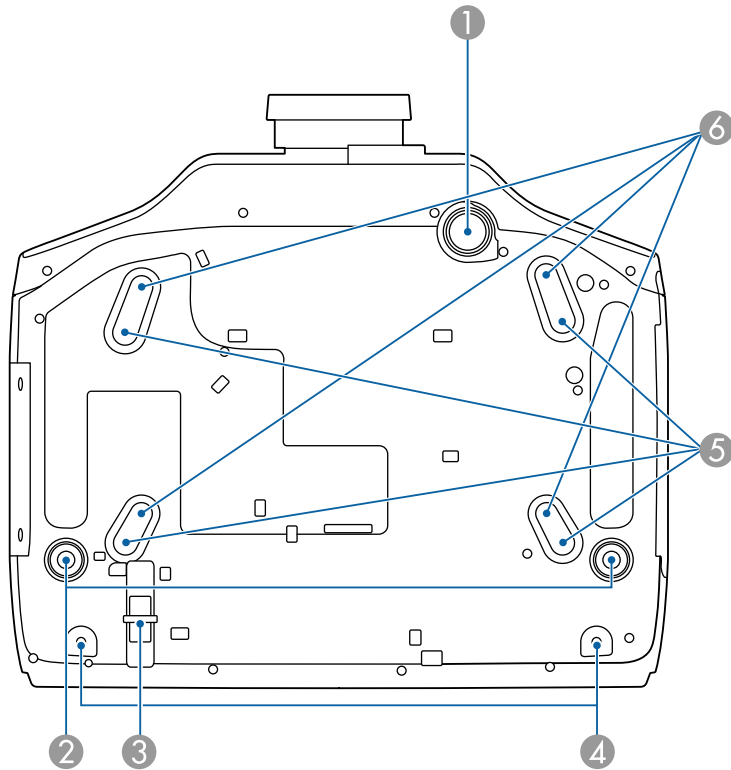

Name	Function
1 Front adjustable foot	When setup on a surface such as a desk, extend the foot to adjust the position of the image. ☛ "Adjusting the Height of the Projected Image (for Normal Installation)" p.40
2 Rear feet	When setup on a surface such as a desk, turn to extend and retract to adjust the horizontal tilt. ☛ "Adjusting the Horizontal Tilt (for Normal Installation)" p.41

Name	Function
3 Security cable installation point	Pass a commercially available wire lock through here and lock it in place. ☛ "Installing the wire lock" p.130
4 Screw holes to fix the cable cover	Screw holes to fix the cable cover in place. ☛ "Attaching the Cable Cover" p.53
5 Ceiling mount fixing points (for ELPMB47/ELPMB48, four points)	Attach the optional Ceiling Mount here when suspending the projector from a ceiling. ☛ "Installing the Projector" p.26
6 Ceiling mount fixing points (for ELPMB22, four points)	☛ "Optional Accessories" p.215

Control Panel

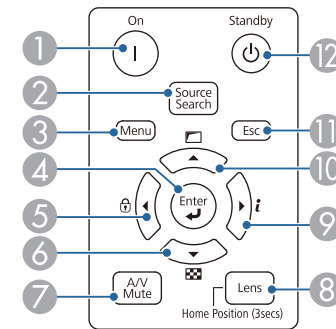

Name	Function
1 [On] button	Turns the projector on.
2 [Source Search] button	Changes to the next input source that is sending an image. ☛ "Automatically Detecting Input Signals and Changing the Projected Image (Source Search)" p.59
3 [Menu] button	Displays and closes the Configuration menu. ☛ "Using the Configuration Menu" p.132

Name	Function
4 [↵] button	<ul style="list-style-type: none"> When the Configuration menu or the Help screen is displayed, it accepts and enters the current selection and moves to the next level. If pressed while projecting analog RGB signals from the Computer port or the BNC port, you can automatically optimize Tracking, Sync., and Position.
5 [↶]/[⏸] buttons	<ul style="list-style-type: none"> Displays the Control Panel Lock screen allowing you to make settings to lock the control panel buttons. <ul style="list-style-type: none"> "Restricting Operation" p.128 If pressed when the Configuration menu or the Help screen is displayed, this button selects menu items and setting values. <ul style="list-style-type: none"> "Using the Configuration Menu" p.132 "Using the Help" p.162
6 [↷]/[⏹] buttons	<ul style="list-style-type: none"> Displays a test pattern. <ul style="list-style-type: none"> "Displaying a Test Pattern" p.32 If pressed when the Configuration menu or the Help screen is displayed, this button selects menu items and setting values. <ul style="list-style-type: none"> "Using the Configuration Menu" p.132 "Using the Help" p.162
7 [A/V Mute] button	<p>Turns the video and audio on or off.</p> <ul style="list-style-type: none"> "Hiding the Image and Sound Temporarily (A/V Mute)" p.117
8 [Lens] button	<p>Displays the adjustment screens for lens shift, zoom, focus, and distortion in that order each time the button is pressed.</p> <p>If pressed for more than three seconds, the lens position moves to the home position.</p>

Name	Function
9 [▶]/[i] buttons	<ul style="list-style-type: none"> Displays the Info menu from the Configuration menu. <ul style="list-style-type: none"> "Info Menu (Display Only)" p.152 If pressed when the Configuration menu or the Help screen is displayed, this button selects menu items and setting values. <ul style="list-style-type: none"> "Using the Configuration Menu" p.132 "Using the Help" p.162
10 [▲]/[□] buttons	<ul style="list-style-type: none"> Performs screen adjustments using the settings in Geometric Correction from the Configuration menu. <ul style="list-style-type: none"> Settings - Geometric Correction p.138 If pressed when the Configuration menu or the Help screen is displayed, this button selects menu items and setting values. <ul style="list-style-type: none"> "Using the Configuration Menu" p.132 "Using the Help" p.162
11 [Esc] button	<ul style="list-style-type: none"> Stops the current function. If pressed when the Configuration menu is displayed, it moves to the previous menu level. <ul style="list-style-type: none"> "Using the Configuration Menu" p.132
12 [⏻] button	<p>Turns the projector off.</p>

Remote Control

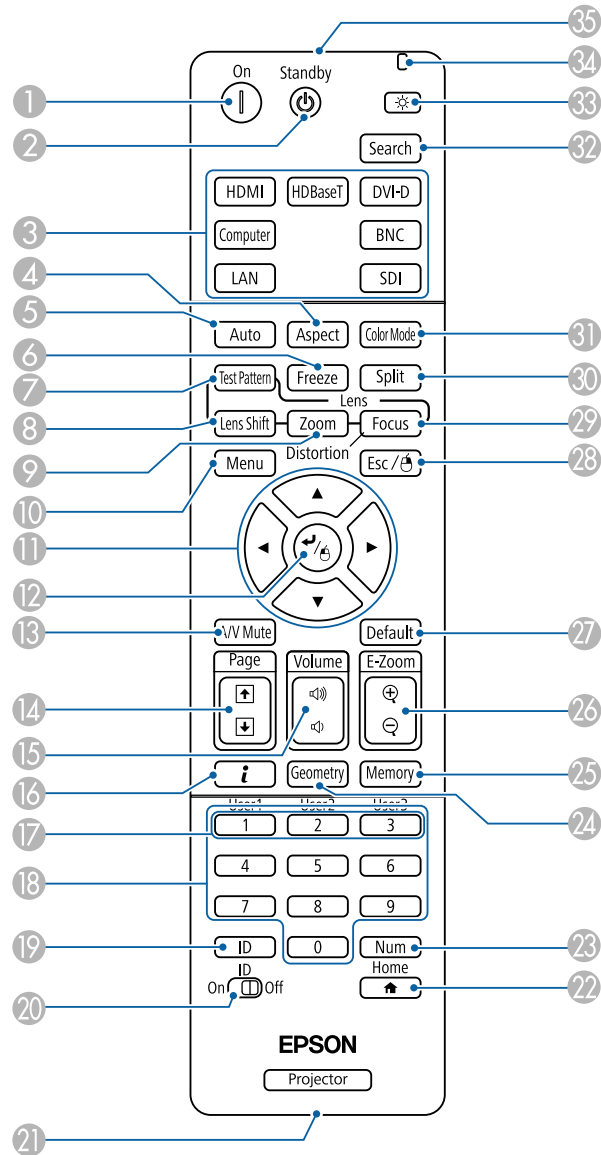

Name	Function
1 [On/Standby] button	Turns the projector on.
2 [Power] button	Turns the projector off.
3 Change input buttons	Changes to images from each input port. ☛ "Switching to the Target Image by Remote Control" p.60 The [SDI] button is not available for this projector.
4 [Aspect] button	Each time the button is pressed, the aspect mode changes. ☛ "Changing the Aspect Ratio of the Projected Image" p.87
5 [Auto] button	If pressed while projecting analog RGB signals from the Computer port or the BNC port, you can automatically optimize Tracking, Sync., and Position.
6 [Freeze] button	Images are paused or unpaused. ☛ "Freezing the Image (Freeze)" p.118
7 [Test Pattern] button	Displays a test pattern. ☛ "Displaying a Test Pattern" p.32
8 [Lens Shift] button	Press to adjust the lens shift. ☛ "Adjusting the Position of the Projected Image (Lens Shift)" p.33 If pressed for more than three seconds, the lens position moves to the home position.
9 [Zoom] button	Press to adjust the zoom. ☛ "Adjusting the Image Size" p.36
10 [Menu] button	Displays and closes the Configuration menu. ☛ "Using the Configuration Menu" p.132

	Name	Function
11	[▲][▼][◀][▶] buttons	<ul style="list-style-type: none"> Press to adjust focus, distortion, zoom, and lens shift. <ul style="list-style-type: none"> "Adjusting the Position of the Projected Image (Lens Shift)" p.33 "Adjusting the Image Size" p.36 "Correcting the Focus" p.37 When the Configuration menu or the Help screen is displayed, pressing these buttons selects menu items and setting values. <ul style="list-style-type: none"> "Using the Configuration Menu" p.132 When using the optional wireless mouse receiver, pressing these buttons moves the pointer. <ul style="list-style-type: none"> "Optional Accessories" p.215
12	[↵] button	<ul style="list-style-type: none"> When the Configuration menu or the Help screen is displayed, it accepts and enters the current selection and moves to the next level. <ul style="list-style-type: none"> "Using the Configuration Menu" p.132 Acts as a mouse's left button when using the optional wireless mouse receiver. <ul style="list-style-type: none"> "Optional Accessories" p.215
13	[A/V Mute] button	<p>Turns the video and audio on or off.</p> <ul style="list-style-type: none"> "Hiding the Image and Sound Temporarily (A/V Mute)" p.117
14	[Page] buttons [+] [−]	<ul style="list-style-type: none"> Press to change the test pattern while a test pattern is displayed. Moves to the previous or next image file when projecting images from a computer connected via a network. When using the optional wireless mouse receiver, you can change the PowerPoint file page during projection by pressing the page up/page down buttons.
15	[Volume] buttons [◀] [▶]	<p>[◀] Decreases the volume. [▶] Increases the volume.</p> <ul style="list-style-type: none"> "Adjusting the Volume" p.61

	Name	Function
16	[i] button	<p>Displays the Info menu from the Configuration menu.</p> <ul style="list-style-type: none"> "Info Menu (Display Only)" p.152
17	[User1] button [User2] button [User3] button	<p>Select any frequently used item from the Configuration menu items, and assign it to any of these buttons. By pressing the button, the assigned menu item selection/adjustment screen is displayed, allowing you to make one-touch settings/adjustments.</p> <ul style="list-style-type: none"> "Settings Menu" p.138
18	Numeric buttons	<ul style="list-style-type: none"> Enter the Password. <ul style="list-style-type: none"> "Setting Password Protection" p.126 Use this button to enter numbers in Network settings from the Configuration menu.
19	[ID] button	<p>Hold down this button and press the numeric buttons to select the ID for the projector you want to operate using the remote control.</p> <ul style="list-style-type: none"> "ID Settings" p.41
20	[ID] switch	<p>Use this switch to enable (On)/disable (Off) ID settings for the remote control.</p> <ul style="list-style-type: none"> "ID Settings" p.41
21	Remote port	<p>Connects the optional remote control cable set and outputs signals from the remote control.</p> <ul style="list-style-type: none"> "Optional Accessories" p.215 <p>When the remote control cable is plugged into this remote port, the remote control light-emitting is disabled.</p>
22	[Home] button	<p>Displays and closes the Home screen.</p> <ul style="list-style-type: none"> "Home screen" p.57
23	[Num] button	<p>Hold down this button and press the numeric buttons to enter passwords and numbers.</p> <ul style="list-style-type: none"> "Setting Password Protection" p.126
24	[Geometry] button	<p>Corrects distortion in the projected image.</p> <ul style="list-style-type: none"> "Correcting Distortion in the Projected Image" p.62

Name	Function
25 [Memory] button	Performs operations and makes settings for the memory function. ☛ "Memory Function" p.121
26 [E-Zoom] buttons [+][−]	Enlarges or reduces the image without changing the projection size. ☛ "Enlarging Part of the Image (E-Zoom)" p.118
27 [Default] button	Enabled when [Default]: Reset is displayed on the configuration menu guide. The settings being adjusted are returned to their default values. ☛ "Using the Configuration Menu" p.132
28 [Esc] button	<ul style="list-style-type: none"> • Stops the current function. • If pressed when the Configuration menu is displayed, it moves to the previous level. ☛ "Using the Configuration Menu" p.132 • Acts as a mouse's right button when using the optional wireless mouse receiver. ☛ "Optional Accessories" p.215
29 [Focus] button	Each time the button is pressed, the adjustment screens for focus and distortion are displayed in that order. ☛ "Correcting the Focus" p.37
30 [Split] button	Each time the button is pressed, the image changes between projecting two images simultaneously by splitting the projected screen, or projecting one image as normal. ☛ "Projecting Two Images Simultaneously (Split Screen)" p.114
31 [Color Mode] button	Each time the button is pressed, the Color Mode changes. ☛ "Selecting the Projection Quality (Selecting Color Mode)" p.86
32 [Search] button	Changes to the next input source that is sending an image. ☛ "Automatically Detecting Input Signals and Changing the Projected Image (Source Search)" p.59

Name	Function
33 [☀] button	Illuminates the buttons on the remote control for approximately 15 seconds. This is useful when using the remote control in the dark.
34 Indicator	A light is emitted when outputting remote control signals.
35 Remote control light-emitting area	Outputs remote control signals.

You can perform the following operations by simply pressing one of the buttons on the remote control.

Operation	Settings
Reverse the projected image vertically. (Switch the Projection between Front and Front/Ceiling) ☛ "Changing the direction of the image (projection mode)" p.29	Hold down the [A/V Mute] button for more than five seconds.
Selecting the password security settings. ☛ "Managing Users (Password Protection)" p.126	Hold down the [Freeze] button for more than five seconds. The Password Protection screen is displayed, and you can select various settings.
Locking or unlocking some of the operation of the buttons on the remote control. ☛ "Remote control button lock" p.129	Hold down the [] button for more than five seconds.
Initializing the settings for the Remote Receiver in the Configuration menu. (Enables all Remote receiver for this projector.)	Hold down the [Menu] button for more than 15 seconds.

Operation	Settings
Displaying frequently used Configuration menu items.	Press the [User1], [User2], or [User3] button. You can set the menu item you want to assign to each button in User Button . ☛ Settings - User Button p.138 The following items can be assigned. Power Consumption (supported models only), Multi-Projection , Resolution , Image Processing , On-Screen Display , Display the QR Code , Image Enhancement , Frame Interpolation When you press the button for which On-Screen Display is assigned, menu or messages are not displayed on the screen. When the same button is pressed, they are displayed again. If On-Screen Display is enabled, you cannot operate the Configuration menu (except switching the color mode and input source).

Replacing the remote control batteries

If delays in the responsiveness of the remote control occur or if it does not operate after it has been used for some time, it probably means that the batteries are becoming flat. When this happens, replace them with new batteries. Have two AA size alkaline or manganese batteries ready. You cannot use other batteries except for the AA size alkaline or manganese.

Attention

Make sure you read the following manual before handling the batteries.

☛ [Safety Instructions](#)

- 1** Remove the battery cover.
While pushing the battery compartment cover catch, lift the cover up.

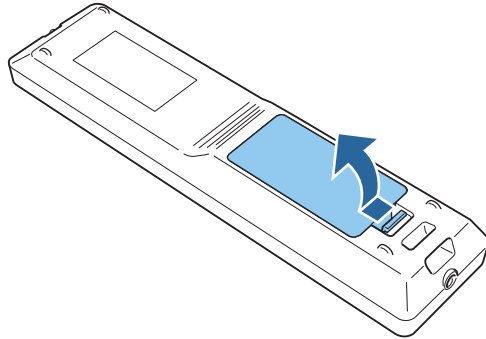

- 2** Replace the old batteries with new batteries.

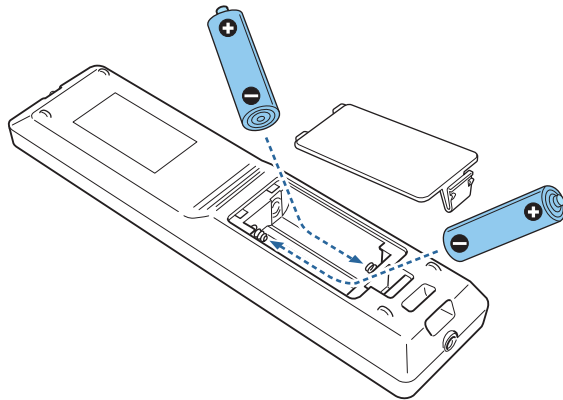

⚠ Caution

Check the positions of the (+) and (-) marks inside the battery holder to ensure the batteries are inserted the correct way.

If the batteries are not used correctly, they could explode or leak causing a fire, injury, or damage to the product.

- 3** Replace the battery cover.
Press the battery compartment cover until it clicks into place.

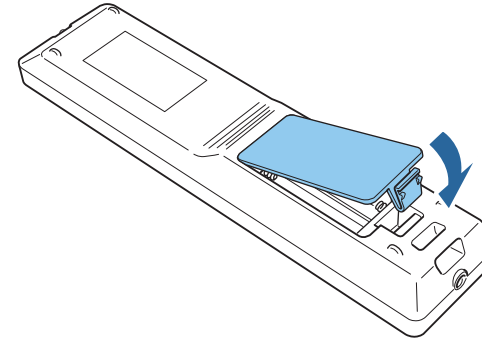

Remote control operating range

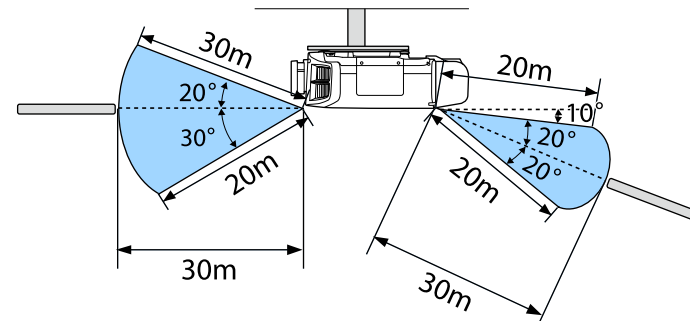
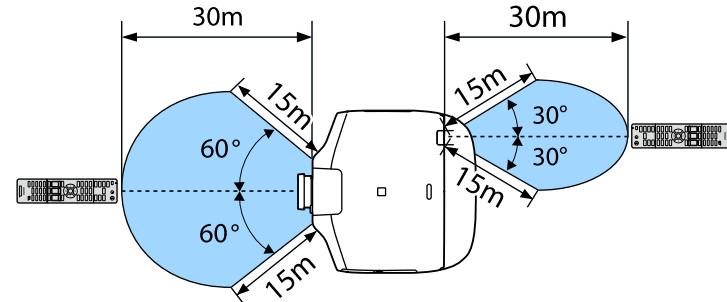



To restrict reception of the operation signals from the remote control, set **Remote Receiver**.

☛ **Settings - Remote Receiver** [p.138](#)

Connecting a Cable to the Remote Control

You can make operations securely with the optional remote control cable set when you use multiple units of this projector in the same place or when there are obstacles around the remote receiver.

☛ "Optional Accessories" [p.215](#)

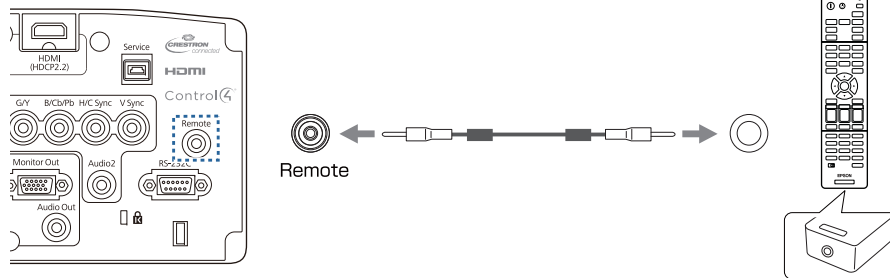

- When the remote control cable is plugged into the Remote port, the remote receiver on the projector is disabled.
- You can also connect the optional HDBaseT transmitter and remote control with the cable to control the projector.
☛ "Connecting an HDBaseT Transmitter" [p.51](#)



Preparing the Projector

This chapter explains how to install the projector and connect projection sources.

Removing and Attaching the Projector Lens Unit

Attaching

Attention

- When attaching the lens unit, remove the power plug from the electrical outlet first.
- Do not attach the lens unit when the projector's lens insertion section is facing up. Dust or dirt could enter the projector.
- Try not to touch the lens section with your hand or fingers. If fingerprints or oils are left on the surface of the lens, projection quality deteriorates.



- The projector supports lens with the following model numbers. ELPLM08, ELPLX01, ELPLU03, ELPLU04, ELPLW05, ELPLW06, ELPLM09, ELPLM10, ELPLM11, ELPLL08, ELPLS04, ELPLU02, ELPLR04, ELPLW04, ELPLM06, ELPLM07, ELPLL07

When using the following lens, set the **Lens Type** in the Configuration menu according to the lens you are using so that distortion correction is performed correctly.

ELPLS04, ELPLU02, ELPLR04, ELPLW04, ELPLM06, ELPLM07, ELPLL07

☛ **Extended - Operation - Advanced - Lens Type** [p.140](#)

- In a normal installation, the image may be tilted depending on your lens. Adjust the tilt of the image using the rear feet.
☛ "Adjusting the Horizontal Tilt (for Normal Installment)" [p.41](#)

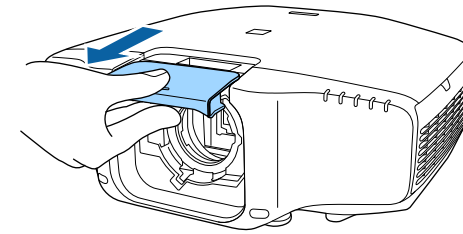

- 2 Hold the lock lever and turn it counterclockwise.

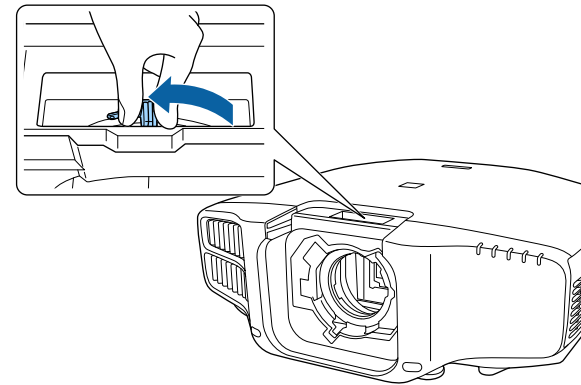

When using the following lens, attach the supplied lens connector cap to protect the port.

ELPLS04, ELPLU02, ELPLR04, ELPLW04, ELPLM06, ELPLM07, ELPLL07

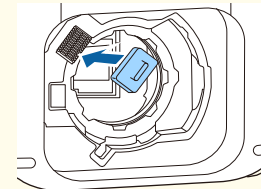

- 1 Pull the lens replacement cover straight out.

- 3 Insert the lens unit straight into the lens insertion section with the white circle on the lens on top.

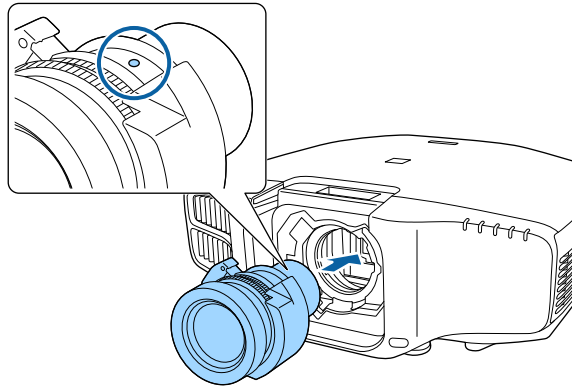

- 4** While holding the lens unit firmly, hold the lock lever and turn it clockwise to lock the lens unit.
Check that the lens cannot be detached.

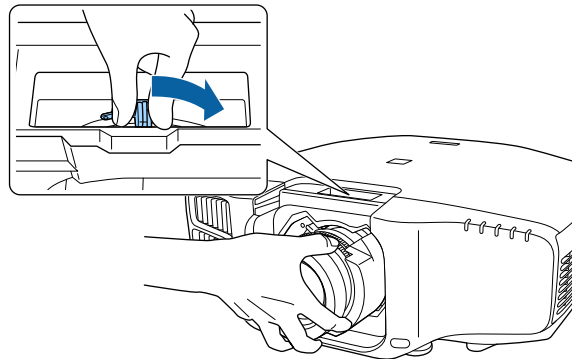

- 5** Attach the lens replacement cover.

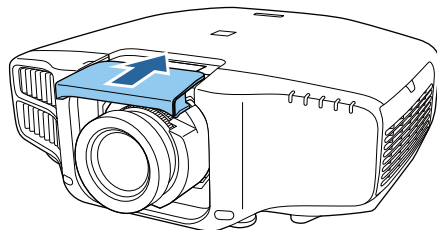

Lens Calibration

After replacing the lens unit, calibrate the lens so that the projector can correctly acquire the lens position and adjustment range.

After attaching a lens unit with a different model number to the previous one, a message is displayed when the projector is turned on.

Select **Yes** to calibrate the lens.

Lens calibration takes up to about 100 seconds until it is complete. When it is complete, the lens position returns to the position before the calibration (ELPLX01 returns to the standard position).

Attention

If the message "Lens Calibration failed." is displayed, stop using the projector, remove the power plug from the electrical outlet, and contact your local dealer or the nearest address provided in the Epson Projector Contact List.

☞ [Epson Projector Contact List](#)



- You can also calibrate the lens from the Configuration menu.
 - ☞ **Extended - Operation - Lens Calibration** p.140
- If no message is displayed after attaching the lens unit, perform lens calibration from the Configuration menu.
- If you do not calibrate the lens, the following functions may not operate correctly.
 - Focus, Distortion, Zoom, Lens Shift, Memory (Lens Position)

Removing

Attention

When replacing the lens unit, remove the power plug from the electrical outlet first. If the lens shift has been done, move the lens position to the home position before replacing the lens unit.

☛ "Adjusting the Position of the Projected Image (Lens Shift)" p.33

- 1 Pull the lens replacement cover straight out.

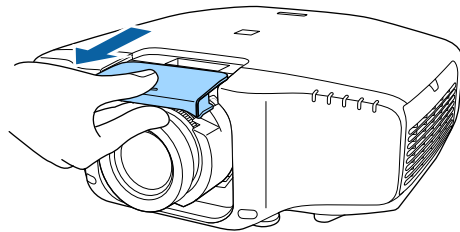

- 2 While holding the lens unit firmly, hold the lock lever and turn it counterclockwise to unlock the lens unit.
Pull the lens unit straight out as it is released.

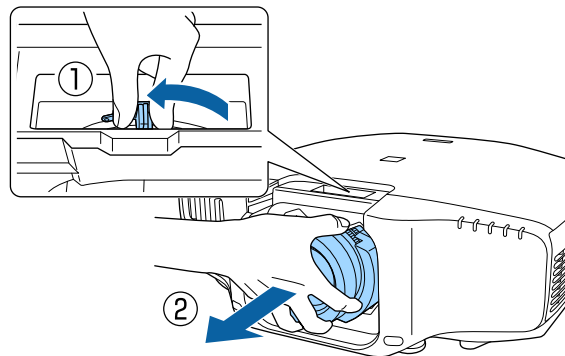

Installation Settings

Setting the direction

When installation is complete, set the **Direction** from the configuration menu according to the vertical installation angle.

Attention

Make sure you set **Direction** correctly. If it is not set, the projector does not cool down correctly, and the lamps may deteriorate.

- 1 Press the [Menu] button while projecting.
- 2 Select **Direction** from **Extended**.
- 3 Select **Direction**.



- For portrait installation, set **Portrait Mode** to **On**.
☛ **Extended - Direction - Portrait Mode** p.140
- For normal installation, set **Portrait Mode** to **Off**. When **Portrait Mode** is **On**, you cannot set **Direction**.
- If the **Portrait Mode** setting is changed, the **Power Consumption** and **Brightness Level** settings may change.

- 4 Use the [◀][▶] buttons to set the projector's installation angle.
Each time you press one of the buttons, the angle of tilt changes by 15 degrees. Set as close to the actual setup angle as possible.

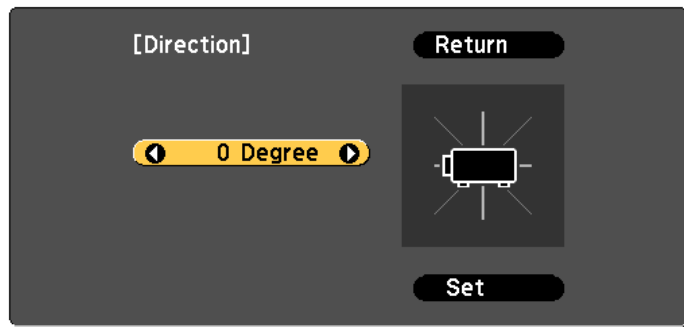

[Esc] :Return [↩]:Select [⬅]:Rotate [Menu]:Exit

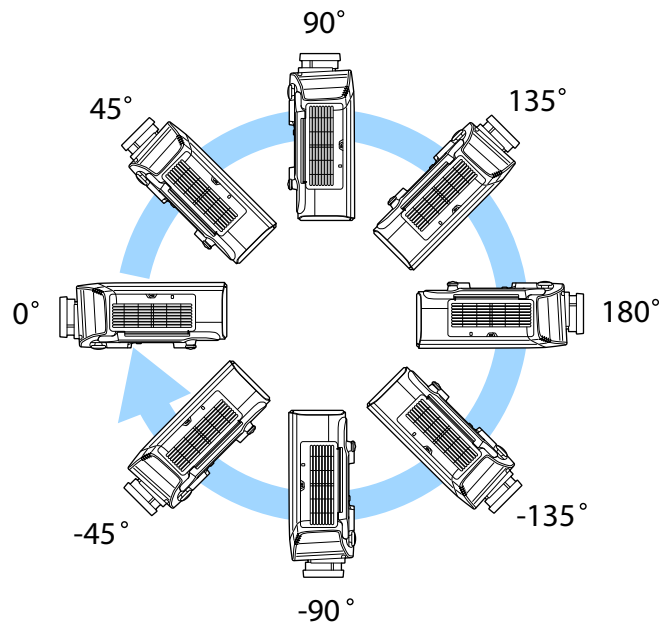

Changing the direction of the image (projection mode)

You can change the direction of the image using **Projection** mode from the Configuration menu.

☛ **Extended - Projection** p.140

When Front is the standard, the image directions for each projection mode are as follows.

Front (default)



Rear



Front/Ceiling



Rear/Ceiling



- 5 When you have finished making settings, use the [▼] button to select **Set**, and then press the [↵] button.



- You can change the setting as follows by pressing down the [A/V Mute] button on the remote control for about five seconds.
Front ↔ Front/Ceiling
Rear ↔ Rear/Ceiling
- Make sure you check the **Direction** setting when you change the projector's installation position.
☛ **Extended - Direction** p.140
- When suspending the projector from a ceiling, set the **Inv Direction Button** to **On** so that the [▲], [▼], [◀], and [▶] buttons on the control panel operate in the correct direction.
☛ **Extended - Operation - Inv Direction Button** p.140

Projecting in a portrait installation

Install the projector vertically and project a vertically long screen.

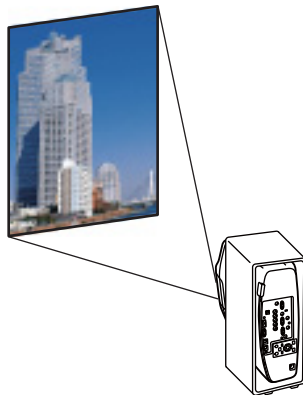

See the following for notes when doing a portrait installation.

☛ "Notes on portrait installation" p.6

When projecting in a portrait installation, set **Portrait Mode** to **On**.

☛ "Setting the direction" p.28

To rotate the menu display, set **OSD Rotation** in the Configuration menu.

- 1** Press the [Menu] button while projecting.
- 2** Select **Display** from **Extended**.
- 3** Select **OSD Rotation**.
- 4** Select **Right 90 Degree**, and then press the [↵] button.
- 5** Press the [Menu] button to finish making settings.



- When projecting in a portrait installation, the brightness is about 80% (90% for EB-G7400U/EB-G7000W) compared to projecting in a normal installation.
- When continually using the projector in a portrait installation, the lamp's operating life is short compared to a normal installation.
☛ "Projector General Specifications" p.239
- When the total projection time in a portrait installation exceeds about 2000 hours, projection stops automatically.
- **Power Consumption** is disabled.
☛ **Settings - Power Consumption** p.138

Screen Settings

Set the Screen Type according to the aspect ratio of the screen being used.

The area where the image is displayed matches the shape of the screen.



The settings for the **Screen Type** at the time of purchase are as follows:

- WUXGA/WXGA projector: **16:10**
- XGA projector: **4:3**

1 Press the [Menu] button while projecting.
 ☛ "Using the Configuration Menu" [p.132](#)

2 Select **Display** from **Extended**.

3 Select **Screen Type** from **Screen**.

4 Select the screen's aspect ratio.

The shape of the background test pattern changes depending on the setting.

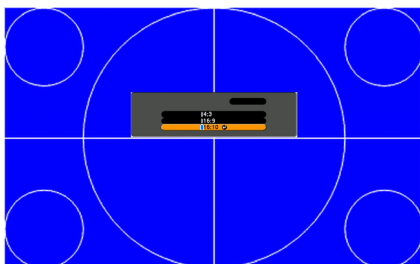

5 Press the [Menu] button to finish making settings.



- When you change the Screen Type, adjust the aspect ratio for the projected image as well.
 ☛ "Changing the Aspect Ratio of the Projected Image " [p.87](#)
- This function does not support Message Broadcasting (an EasyMP Monitor plugin).

Adjusting the position of the image on the projected screen

You can adjust the position of the image if there are margins between the edge of the image and the projected screen frame due to the Screen Type setting.

Example: When the **Screen Type** is set to **4:3** for the WUXGA/WXGA projector



You can move the image to the left and right.

1 Press the [Menu] button while projecting.
 ☛ "Using the Configuration Menu" [p.132](#)

2 Select **Display** from **Extended**.

3 Select **Screen Position** from **Screen**.

4 Use the [▲], [▼], [◀], and [▶] buttons to adjust the position of the image.

You can check the current display position by using the background test pattern.

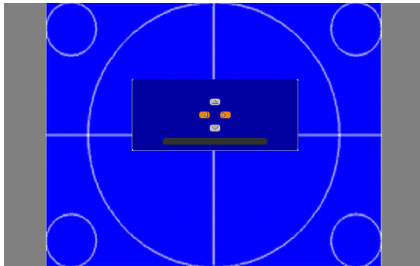

5 Press the [Menu] button to finish making settings.



The **Screen Position** cannot be adjusted in the following situations.

- If you are using a WUXGA/WXGA projector and the **Screen Type** is set to **16:10**
- If you are using an XGA projector and the **Screen Type** is set to **4:3**

Displaying a Test Pattern

A test pattern can be displayed to adjust the projection status without connecting video equipment.

The shape of a test pattern is according to the setting of **Screen Type**. Set **Screen Type** first.

☛ "Screen Settings" [p.30](#)

1 Press the [Test Pattern] button of the remote control or the [] button on the control panel while projecting.

2 Press the [◀][▶] buttons on the remote control or the [↵] button on the control panel to change the test pattern.

Using the remote control

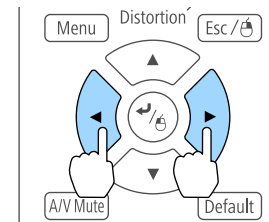



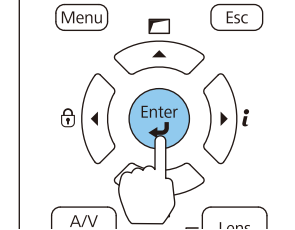

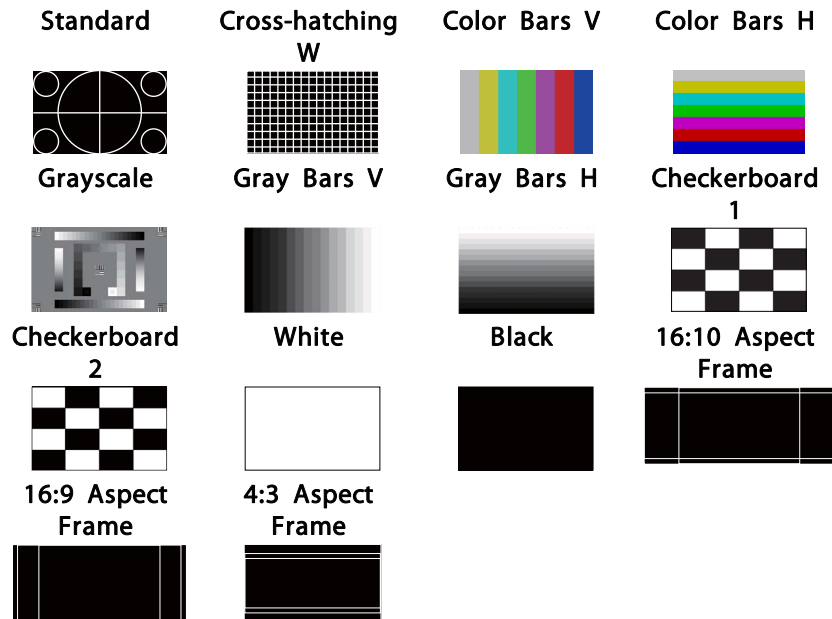
Using the control panel





In addition to lens operations, the following image adjustments can be made while the test pattern is being displayed.

Top Menu Name	Sub Menu/Items
Image	Color Mode  p.86
	White Balance
	Advanced - Gamma*1  p.91 - RGBCMY  p.90
	Reset
Settings	Geometric Correction  p.62
Extended	Multi-Projection*2  p.101

*1 Except for custom settings of gamma

*2 Except for Scale, Color Uniformity, and Black Level



- To set menu items that cannot be set while the test pattern is being displayed or to fine-tune the projected image, project an image from the connected device.
- During image adjustment, press the [↑][↓] [Page] buttons on the remote control to change the test pattern.
- You can also select a test pattern from the Configuration menu.
 [Settings - Test Pattern p.138](#)

3

Press the [Esc] button to close the test pattern.

Adjusting the Position of the Projected Image (Lens Shift)

The lens can be shifted to adjust the position of the projected image, for example, when the projector cannot be installed directly in front of the screen.

The ranges within which the image can be moved are shown below. The position of the projected image cannot be moved to both the horizontal and vertical maximum values.

EB-G7905U/EB-G7900U/EB-G7500U/EB-G7400U/EB-G7200W/EB-G7000W

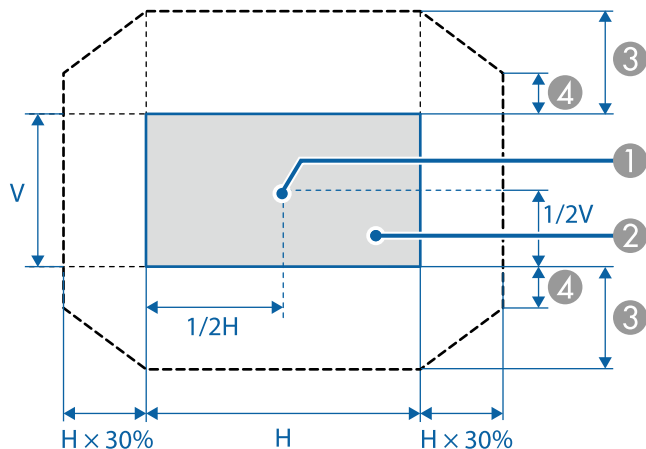

- ① Center of lens
- ② Projected image when the lens position is moved to the home position
- ③ Maximum motion range: $V \times 67\%$
- ④ When the horizontal direction is at the maximum value: $V \times 19\%$

EB-G7805/EB-G7800/EB-G7100

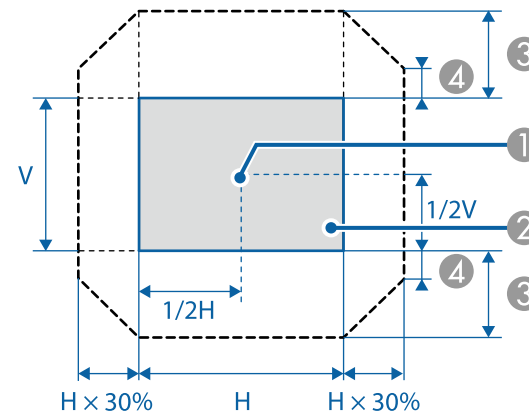

- ① Center of lens
- ② Projected image when the lens position is moved to the home position
- ③ Maximum motion range: $V \times 57\%$
- ④ When the horizontal direction is at the maximum value: $V \times 16\%$

When using the ELPLX01 ultra short throw zoom lens

EB-G7905U/EB-G7900U/EB-G7500U/EB-G7400U/EB-G7200W/EB-G7000W

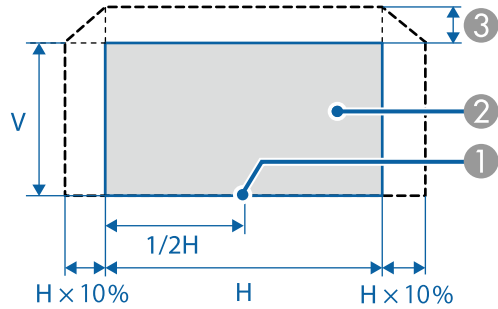

- ① Center of lens
- ② Projected image when the lens position is moved to the home position
- ③ Maximum motion range: $V \times 17\%$

*When the horizontal direction is at the maximum value: The image cannot be moved upward.

EB-G7805/EB-G7800/EB-G7100

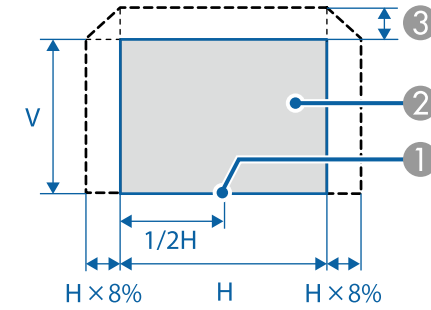

- ① Center of lens
- ② Projected image when the lens position is moved to the home position
- ③ Maximum motion range: $V \times 7\%$

*When the horizontal direction is at the maximum value: The image cannot be moved upward.



- When adjusting the image height with the vertical lens shift, adjust by moving the image from the bottom to the top. If it is adjusted from the top to the bottom, the image position may move down slightly after adjusting.
- We recommend setting the focus, zoom, and lens shift at least 20 minutes after you start the projection, because images are not stable right after turning on the projector.
- The image will be clearest when the lens position is moved to the home position.
- If you hold down the [Lens Shift] button on the remote control or the [Lens] button on the control panel for at least three seconds, the lens position moves to the home position.
- If you set **A/V Output** to **Always On**, you can move the lens position to the home position even if the projector is in standby mode.
 - ☛ **Extended - A/V Settings - A/V Output** p.140
- ELPLR04 does not support lens shift.

1 Press the [Lens Shift] button on the remote control or the [Lens] button on the control panel.

Repeatedly press the [Lens] button on the control panel until the lens shift adjustment screen is displayed.

Using the remote control

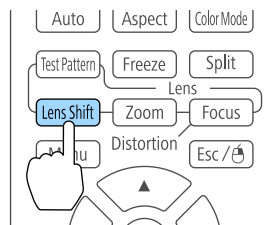

Using the control panel

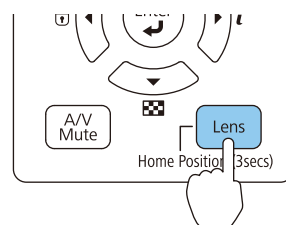

2 Press the [▲][▼][◀][▶] buttons to adjust the position of the projected image.

Using the remote control

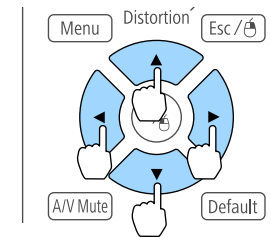

Using the control panel

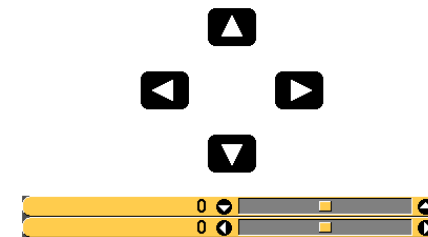
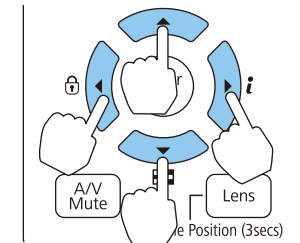

The displayed screen may differ depending on your lens.

3 Press the [Esc] button to finish the adjustment.

Adjusting the Image Size



This is not available for ELPLX01 and ELPLR04.

- 1 Press the [Zoom] button on the remote control or the [Lens] button on the control panel.

Repeatedly press the [Lens] button on the control panel until the zoom adjustment screen is displayed.

Using the remote control

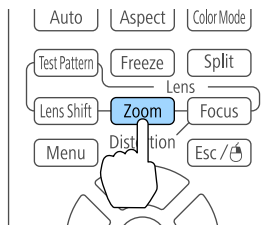

Using the control panel

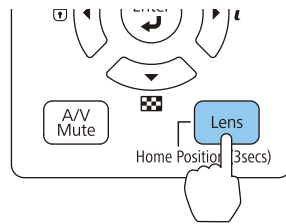

- 2 Press the [◀][▶] buttons to adjust.

Using the remote control

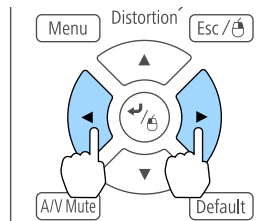

Using the control panel

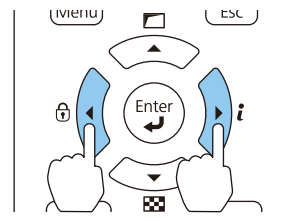

The displayed screen may differ depending on your lens.

- 3 Press the [Esc] button to finish the adjustment.

Correcting the Focus

- 1 Press the [Focus] button or the [Lens] button on the control panel.

Repeatedly press the [Lens] button on the control panel until the focus adjustment screen is displayed.

Using the remote control

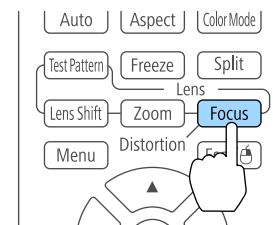

Using the control panel

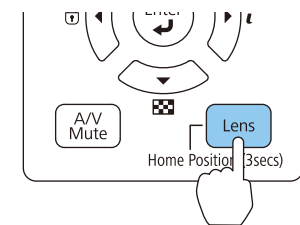

- 2 Press the [◀][▶] buttons to adjust.

Using the remote control

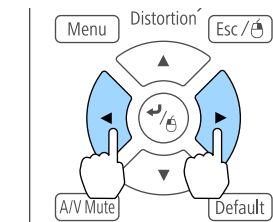

Using the control panel

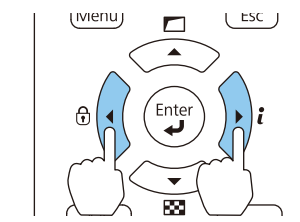

The displayed screen may differ depending on your lens.



When using the following lens, a message prompting you to adjust the distortion (image warping) is displayed. After adjusting the focus, adjust the distortion.

ELPLX01, ELPLU03, ELPLU04, ELPLW05, ELPLU02

☛ "Correcting Distortion (Image Warping)" [p.38](#)

- 3 Press the [Esc] button to finish the adjustment.

Correcting Distortion (Image Warping)

When using a short throw zoom lens and focusing at the center of the screen, the surrounding image may warp and be out of focus. Follow the steps below to correct the warping.

- 1 Press the [Focus] button on the remote control or the [Lens] button on the control panel.
Repeatedly press the [Lens] button on the control panel until the focus adjustment screen is displayed.
- 2 Press the [◀][▶] buttons to focus the image around the center of the lens.

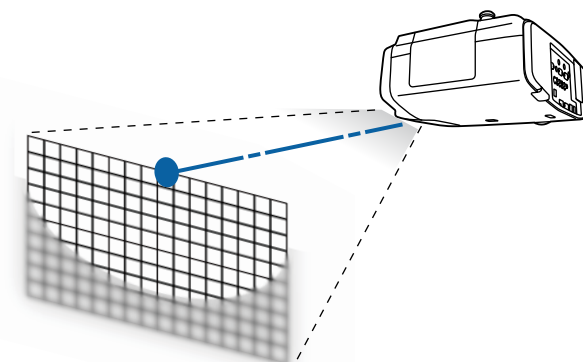

- 3 Press the [Focus] button on the remote control or the [Lens] button on the control panel again.

- 4 Press the [◀][▶] button to adjust the focus of the surrounding area.

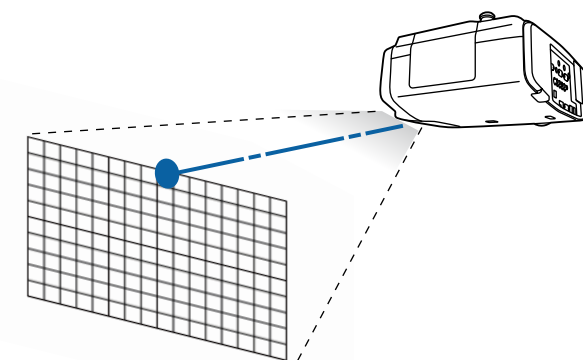



When using the ELPLU02, a message prompting you to manually adjust the distortion is displayed. Turn the distortion ring counterclockwise, and then adjust the focus. After adjusting the focus, manually turn the distortion ring to correct the image warping.

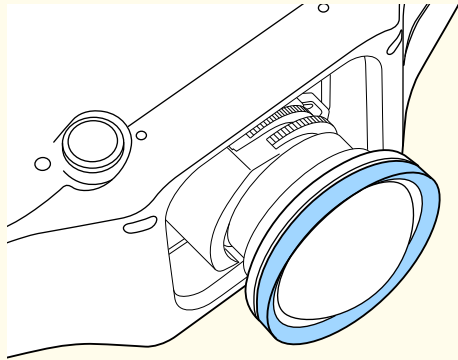

Registering and Loading Lens Adjustment Values

You can register a lens position whose lens shift, zoom, focus, and distortion was adjusted in memory, and load it when necessary. You can register up to 10 values.



- This feature cannot be used if the following lenses are attached. ELPLS04, ELPLU02, ELPLR04, ELPLW04, ELPLM06, ELPLM07, ELPLL07
- If you did not calibrate your lens, a message is displayed when you save a memory. Select **Yes** to calibrate the lens.
- The lens position when a memory is loaded may not completely match the lens position when the memory was saved.
- If there is a large discrepancy between the lens position when a memory is loaded and the lens position when the memory was saved, calibrate the lens.

☛ **Extended - Operation - Lens Calibration** p.140

1 Press the [Memory] button while projecting.

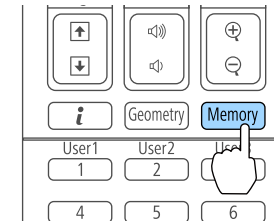

You can also operate from the Configuration menu.

☛ **Settings - Memory** p.138

2 Select **Lens Position**, and then press the [↵] button.

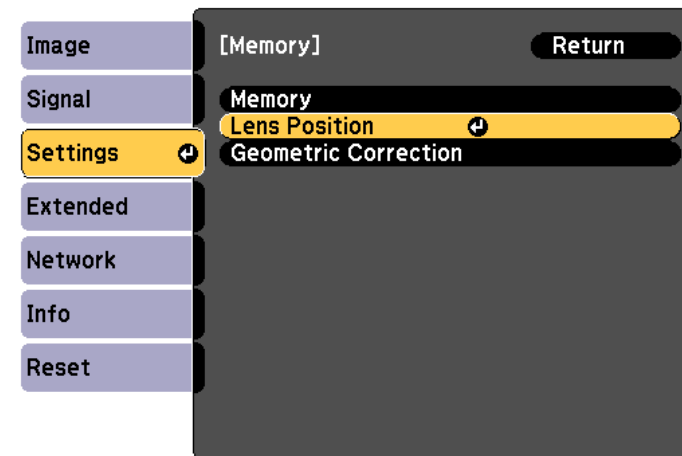

[Esc]:Return [◀]:Select [↵]:Enter [Menu]:Exit

3 Select the function you want to perform, then press the [↵] button.

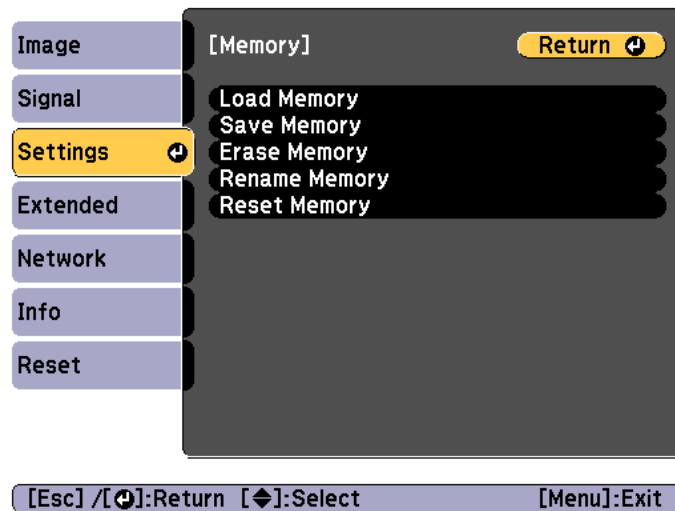

Function	Explanation
Load Memory	Loads the saved memory. When you select a memory name and press the [↵] button, the lens is automatically adjusted according to the settings of the selected memory.
Save Memory	Registers current settings in the memory. When you select a memory name and press the [↵] button, the settings are saved.
Erase Memory	Erases the registered memory. When you select a memory name and press the [↵] button, a message is displayed. Select Yes , and then press the [↵] button to erase the selected memory.

Function	Explanation
Rename Memory	Changes the memory name. Select the memory name you want to change, and then press the [↵] button. Enter the memory name using the soft keyboard. ☞ "Soft keyboard operations" p.146 When you have finished, move the cursor over Finish , and then press the [↵] button.
Reset Memory	Resets the name and settings of a saved memory.

 If the mark on the left of the memory name is turned blue, it means the memory has already been registered. When you select a registered memory, a message is displayed asking you to confirm that you want to overwrite the memory. If you select **Yes**, the previous settings are deleted and the current settings are registered.

Adjusting the Height of the Projected Image (for Normal Installment)

Extend or retract the front foot to make adjustments. You can adjust the position of the image by tilting the projector up to 10 degrees.

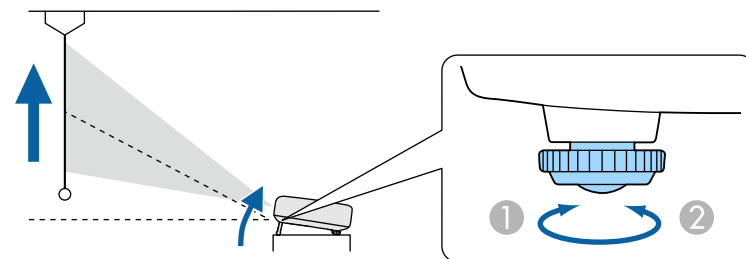

- 1 Extend the front foot.

- Retract the front foot.



The larger the angle of tilt, the harder it becomes to focus. Install the projector so that it only needs to be tilted at a small angle.

Adjusting the Horizontal Tilt (for Normal Installation)

Extend and retract the rear feet to adjust the projector's horizontal tilt.

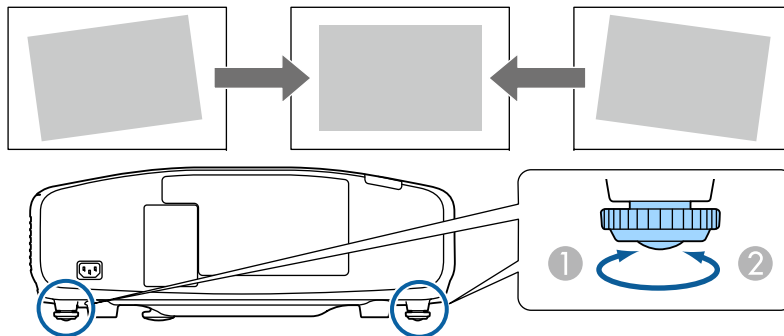

- Extend the rear foot.
- Retract the rear foot.

Attention

The rear feet can be attached and removed. Note that the feet will detach if they are extended more than 10 mm.

ID Settings

When an ID is set for the projector and the remote control, you can use the remote control to operate only the projector with a matching ID. This is very useful when managing multiple projectors. You can set up to 30 IDs.



- Operation using the remote control is possible only for projectors that are within the operating range of the remote control.
 - "Remote control operating range" [p.23](#)
- When **Remote Control Type** is set to **Simple** in the configuration menu, you cannot set the remote control ID.
 - Extended - Operation - Advanced - Remote Control Type** [p.140](#)
- IDs are ignored when the projector ID is set to **Off** or the remote control ID is set to **0**.
- If you use Epson Web Control, you can operate a specific projector from a mobile device.
 - "Changing Settings Using a Web Browser (Epson Web Control)" [p.202](#)

Set the projector ID

- Press the [Menu] button while projecting.
 - "Using the Configuration Menu" [p.132](#)
- Select **Multi-Projection** from **Extended**.
- Select **Projector ID**, and then press the [↵] button.
- Press the [◀][▶] buttons to select an ID number.

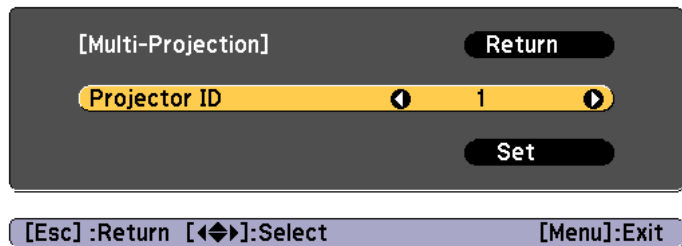

- 5** Select **Set**, and then press the [↵] button.
- 6** Press the [Menu] button to close the Configuration menu.

Checking the projector ID

During projection, press the [⏠] button while holding down the [ID] button.

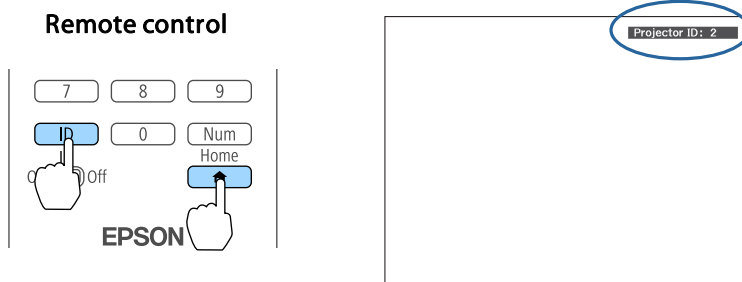

When you press the buttons, the current Projector ID is displayed on the projection screen. It disappears in about three seconds.

Setting the remote control ID

- 1** Set the remote control [ID] switch to On.

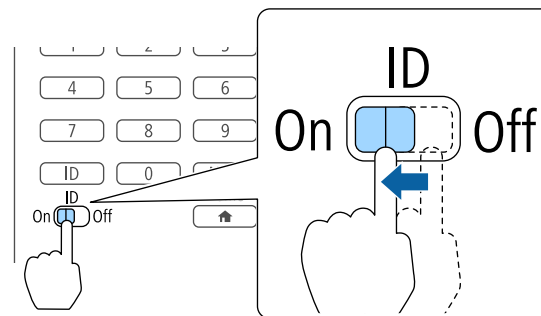

- 2** While holding the [ID] button, press a number button to select a number to match the ID of the projector you want to operate.

☛ "Checking the projector ID" p.42

Enter a two digit number (Example: 01 when the ID is 1).

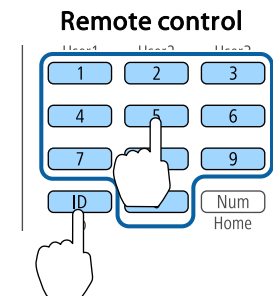

Once this setting has been made, the projector that can be operated by the remote control is limited.



The remote control ID setting is saved in the remote control. Even if the remote control batteries are removed to replace them and so on, the stored ID setting is retained. However, if the batteries are left out for a long time, it is reset to the default value (ID0).

Setting the Time

You can set the time for the projector. The set time is used for the schedule function.

☛ "Scheduling Function" [p.123](#)



- When you turn on the projector for the first time, the message "Do you want to set the time?" is displayed. When you select **Yes**, the screen from step 4 is displayed.
- When **Schedule Protection** is set to **On** in **Password Protection**, settings related to the date and time cannot be changed. You can make changes after setting **Schedule Protection** to **Off**.
☛ "Managing Users (Password Protection)" [p.126](#)

- 1 Press the [Menu] button while projecting.
☛ "Using the Configuration Menu" [p.132](#)
- 2 Select **Operation** from **Extended**.
- 3 Select **Date & Time**, and then press the [↵] button.
- 4 Make settings for the date and time.
Use the soft keyboard to enter the date and time.
☛ "Soft keyboard operations" [p.146](#)

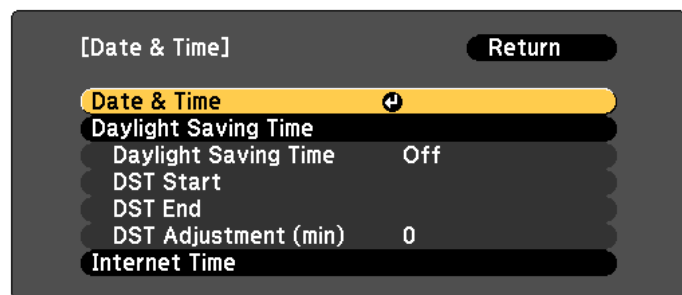

Date & Time

Submenu	Function
Date	Set today's date.
Time	Set the current time.
Time Difference (UTC)	Set the time difference from Coordinated Universal Time.
Set	The settings made in Date & Time are applied.

Daylight Saving Time

Submenu	Function
Daylight Saving Time	Set whether or not (On/Off) to activate the daylight saving time. DST Adjustment (min) adjusts the time difference between the standard time and daylight saving time.
DST Start	Set the date and time to start the daylight saving time.
DST End	Set the date and time to end the daylight saving time.
Set	The settings made in Daylight Saving Time are applied.

Internet Time

Submenu	Function
Internet Time	Set to On to update the time automatically through an Internet time server.
Internet Time Server	Input the IP address for an Internet time server.
Set	The settings made in Internet Time are applied.









When changing settings, make sure you select **Set**, and then press the [↵] button.

- 5** Press the [Menu] button to finish making settings.

Other Settings

Settings related to basic operations

Purpose	Setting Methods
To start/stop projection by turning on/off the main power or plugging in or unplugging the power plug of the projector.	Set Direct Power On to On . (Default value: Off)  Extended - Operation - Direct Power On p.140 The projector can be powered off directly by the breaker because it supports the direct shutdown function.
To disable the automatic shutdown function.	Set Sleep Mode to Off . (Default value: On)  Extended - Operation - Sleep Mode p.140 Set A/V Mute Timer to Off .  Extended - Operation - A/V Mute Settings - A/V Mute Timer p.140
To disable buzzer beeps generated when the projector is powered on/off.	Set Beep to Off . (Default value: On)  Extended - Operation - Advanced - Beep p.140
To operate the projector by communication command even when the power of the projector is off.	Set Standby Mode to Communication On . (Default value: Communication Off)  Extended - Standby Mode p.140
To operate the projector by communication command while executing A/V Mute.	Set A/V Mute Release to A/V Mute .  Extended - Operation - A/V Mute Settings - A/V Mute Release p.140 The default value is Any Button . If you operate the projector while A/V Mute is on, A/V Mute is released.
To turn off the power by pressing the [⏻] button once.	Set Standby Confirmation to Off . (Default value: On)  Extended - Display - Standby Confirmation p.140

Settings related to display

Purpose	Setting Methods
To change the menu position.	Change the settings of Menu Position . ☛ Extended - Display - Menu Position p.140
To change the menu direction.	Change the settings of OSD Rotation . ☛ Extended - Display - OSD Rotation p.140
To prevent the display of menus, messages, or warnings on the screen.	Use User Button to set On-Screen Display to User Button 1 , User Button 2 , or User Button 3 . ☛ Settings - User Button p.138 When you press the button for which On-Screen Display is assigned, menus or messages are not displayed on the screen. When the same button is pressed, they are displayed again. If On-Screen Display is enabled, you cannot operate the Configuration menu (except switching the color mode and input source).
To disable the display of the message on the projection screen when switching the source.	Set Messages to Off . (Default value: On) ☛ Extended - Display - Messages p.140 You can confirm warning by the display of the indicator. ☛ "Reading the Indicators" p.164 Dialogs related to operations and behaviors, lamp replacement notification, termination of Message Broadcasting, and projector ID are displayed.
To reduce the display delay of the image.	Set Image Processing to Fast 1 or Fast 2 . ☛ Signal - Advanced - Image Processing p.137

Purpose	Setting Methods
To register and save the settings of the projected image.	Set Memory . ☛ "Memory Function" p.121 You can save the following settings. <ul style="list-style-type: none"> • Memory: Some settings in the Configuration menu • Lens Position: Adjustment values of the lens shift, zoom, focus, and distortion • Geometric Correction: Adjustment value of the geometric correction
To change the screen displayed on the background.	Change from Display . You can select from blue, black, and logo. If no logo is registered, the EPSON logo is displayed. Display Background : Set the screen display with no image signal input. (Default value: Blue) ☛ Extended - Display - Display Background p.140 Startup Screen : Set whether or not (On/Off) to display the user logo when the projector is turned on. (Default value: On) ☛ Extended - Display - Startup Screen p.140

The port name, location, and connector orientation differ depending on the source being connected.

Connecting a Computer

To project images from a computer, connect the computer using one of the following methods.

① **When using the supplied computer cable**

Connect the computer's display output port to the projector's Computer port.

You can output audio from the projector's speaker by connecting the audio output port on the computer to the projector's Audio1 port using a commercially available audio cable.

② **When using a commercially available 5BNC cable**

Connect the computer's display output port to the projector's BNC port.

You can output audio from the projector's speaker by connecting the audio output port on the computer to the projector's Audio2 port using a commercially available audio cable.

③ **When using a commercially available HDMI cable**

Connect the HDMI port on the computer to the projector's HDMI port.

You can send the computer's audio with the projected image.

④ **When using a commercially available DVI-D cable**

Connect the DVI-D port on the computer to the projector's DVI-D port.

You can output audio from the projector's speaker by connecting the audio output port on the computer to the projector's Audio3 port using a commercially available audio cable.

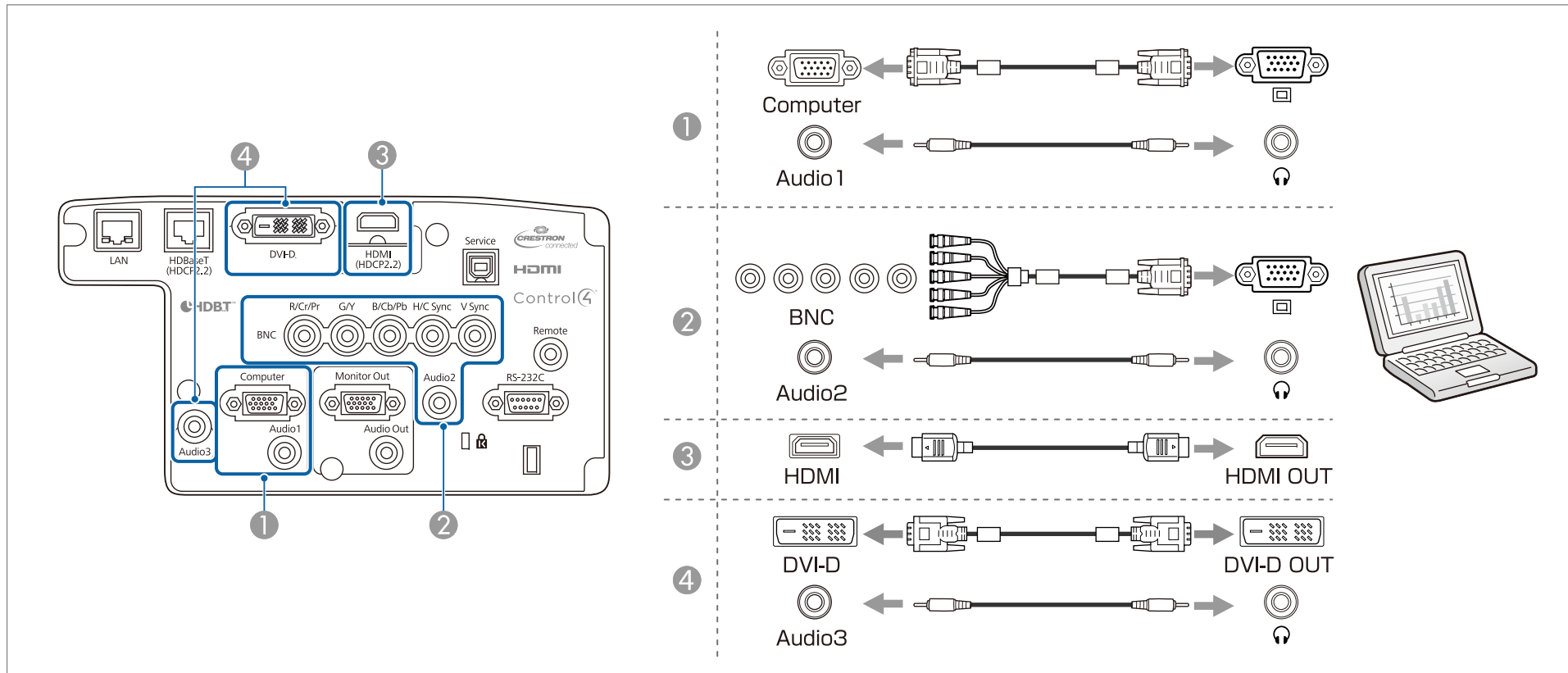

- Change the audio output from **Audio Settings**.
 ➤ **Extended - A/V Settings - Audio Settings** [p.140](#)
- If audio is not sent using an HDMI cable, connect a commercially available audio cable to the Audio3 port to send the audio. Set **HDMI Audio Output** to **Audio3**.
 ➤ **Extended - A/V Settings - Audio Settings - HDMI Audio Output** [p.140](#)

Connecting Image Sources

To project video images, connect to the projector using one of the following methods.

1 When using an optional component video cable (D-sub/component converter)

☛ "Optional Accessories" [p.215](#)

Connect the component output port on the image source to the projector's Computer port.

You can output audio from the projector's speaker by connecting the audio output port on the video equipment to the projector's Audio1 port using a commercially available audio cable.

2 When using a commercially available component video cable (RCA) and a BNC/RCA adapter

Connect the component output port on the video equipment to the projector's BNC port (R/Cr/Pr, G/Y, B/Cb/Pb).

You can output audio from the projector's speaker by connecting the audio output port on the video equipment to the projector's Audio2 port using a commercially available audio cable.

3 When using a commercially available HDMI cable

Connect the HDMI port on the image source to the projector's HDMI port.

You can send the image source's audio with the projected image.

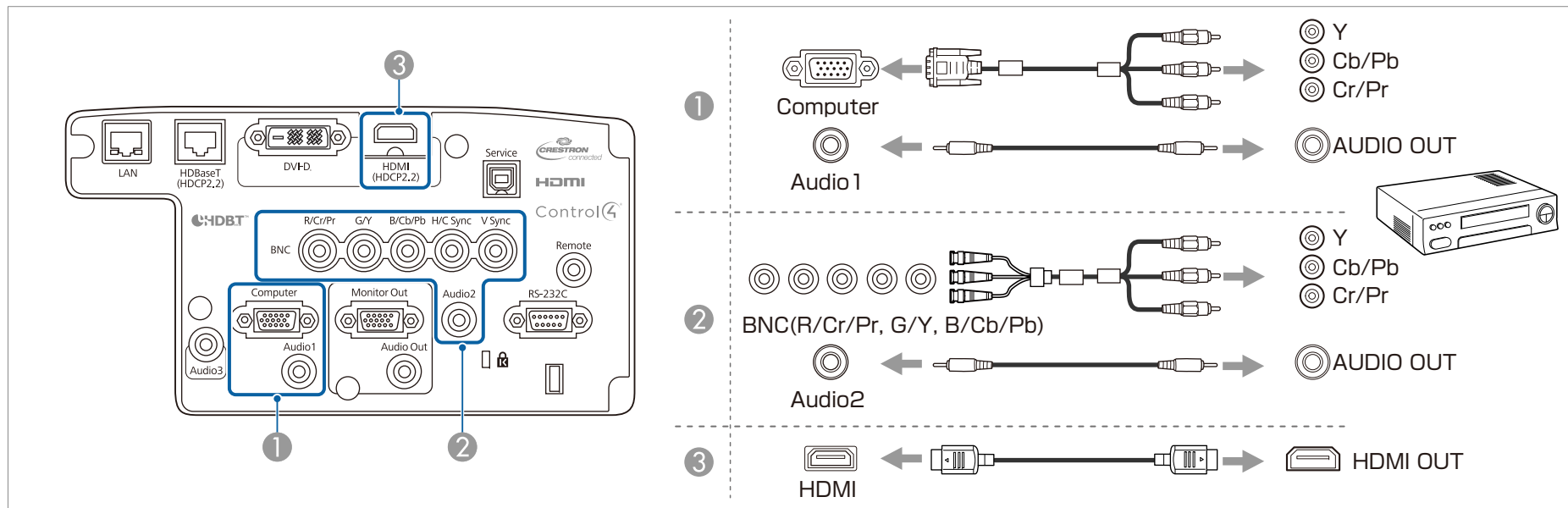

Attention

- If the input source is on when you connect it to the projector, it could cause a malfunction.
- If the orientation or shape of the plug differs, do not try to force it in. The device could be damaged or could malfunction.



- Change the audio output from **Audio Settings**.
 - ☛ **Extended - A/V Settings - Audio Settings** [p.140](#)
- If audio is not sent using an HDMI cable, connect a commercially available audio cable to the Audio3 port to send the audio. Set **HDMI Audio Output** to **Audio3**.
 - ☛ **Extended - A/V Settings - Audio Settings - HDMI Audio Output** [p.140](#)
- If the source you want to connect to has an unusually shaped port, use the cable supplied with the device or an optional cable to connect to the projector.

Connecting External Equipment

You can output images and audio by connecting an external monitor or speaker.

1 When outputting images to an external monitor

Connect the external monitor to the projector's Monitor Out port using the cable supplied with the external monitor.

2 When outputting audio to an external speaker

Connect the external speaker to the projector's Audio Out port using a commercially available audio cable.

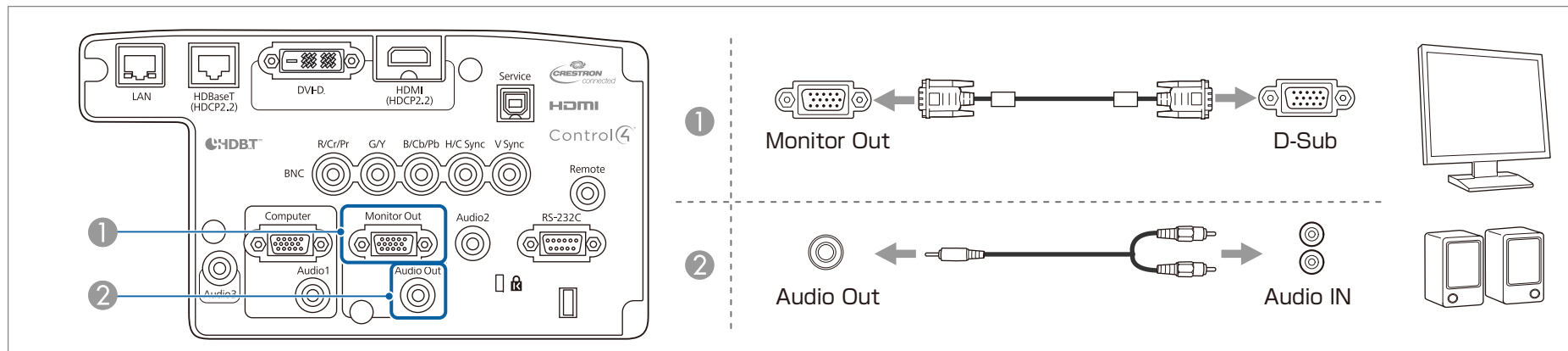



- Set **A/V Output** to **Always On** to output image and audio even when the projector is in standby mode.
 - ☛ **Extended - A/V Settings - A/V Output** p.140
- Only analog RGB signals from the Computer port or BNC port can be output to an external monitor. You can set which signals to output in **Monitor Out**.
 - ☛ **Extended - A/V Settings - Monitor Out** p.140
- When the audio cable jack is inserted into the Audio Out port, audio stops being output from the projector's built-in speakers and switches to external output.

Connecting a LAN Cable

Connect a LAN port on network hubs or other equipment to the projector's LAN port with a commercially available 100BASE-TX or 10BASE-T LAN cable.

By connecting a computer to the projector over a network, you can project images and check the status of the projector.

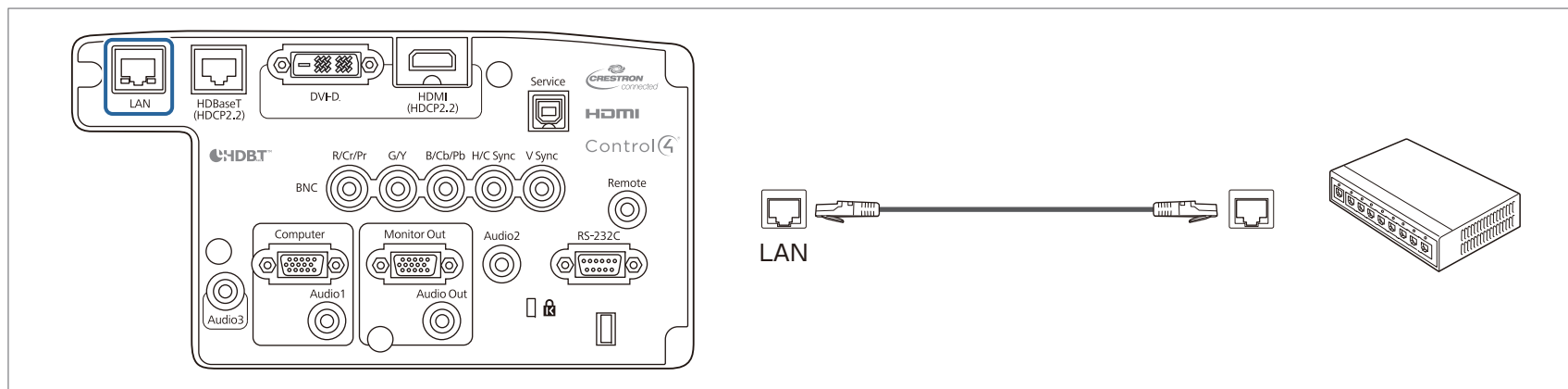

To prevent malfunctions, use a category 5 or higher shielded LAN cable.

Connecting an HDBaseT Transmitter

Connect the optional HDBaseT Transmitter with a commercially available 100BASE-TX LAN cable.

☛ "Optional Accessories" [p.215](#)

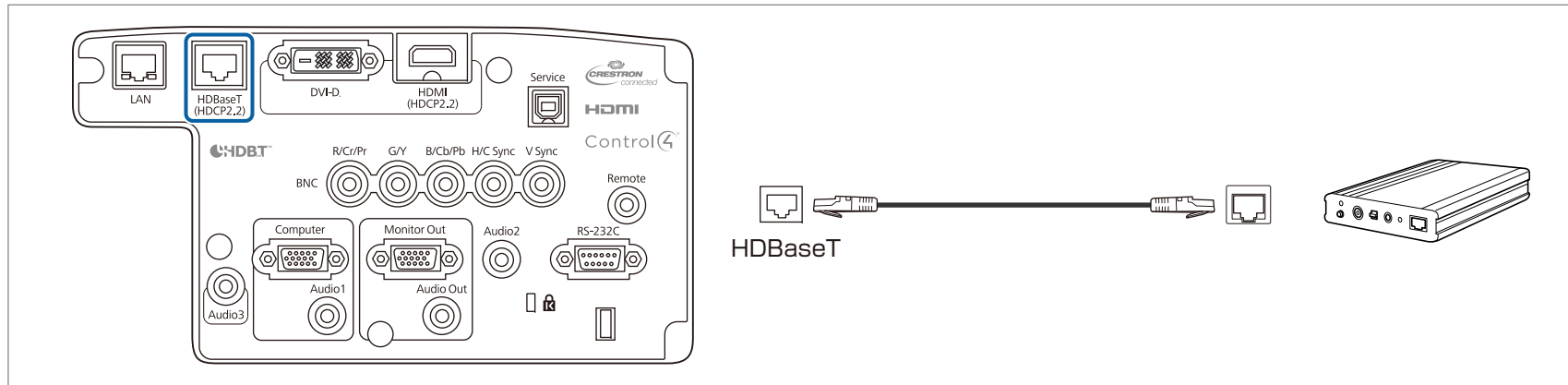

- Make sure you read the User's Guide supplied with the HDBaseT Transmitter carefully before use.
- For the LAN cable, use an HDBaseT Alliance-recommended STP cable (straight) of category 5e or higher. However, operation is not guaranteed for all input/output devices and environments.
- When connecting or disconnecting the LAN cable, make sure you turn off the power for the projector and the HDBaseT Transmitter.
- When performing Ethernet communication or serial communication, or when using the wired remote control via HDBaseT port, set **Control Communications** to **On** from the Configuration menu.
 - ☛ **Extended - HDBaseT - Control Communications** [p.140](#)

Note that when **Control Communications** is set to **On**, the projector's LAN port, RS-232C port, and Remote port are disabled.
- When using the Extron XTP transmitter or switcher, connect to the projector's HDBaseT port. Set **Extron XTP** to **On** (**Standby Mode** and **Control Communications** are automatically set to **On**).
 - ☛ **Extended - HDBaseT - Extron XTP** [p.140](#)

Installing the Wireless LAN Unit

- 1** Open the air filter cover.
Slide the air filter cover operation knob, and open the air filter cover.

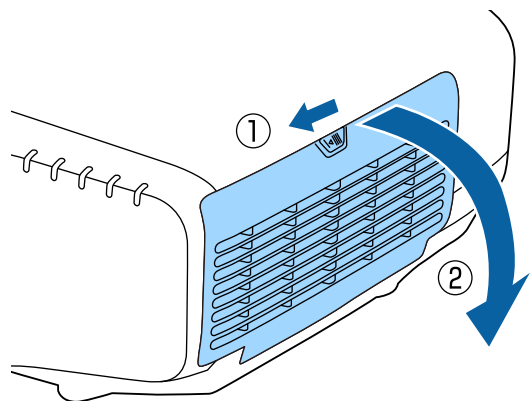

- 2** Remove the stopper for the Wireless LAN unit.

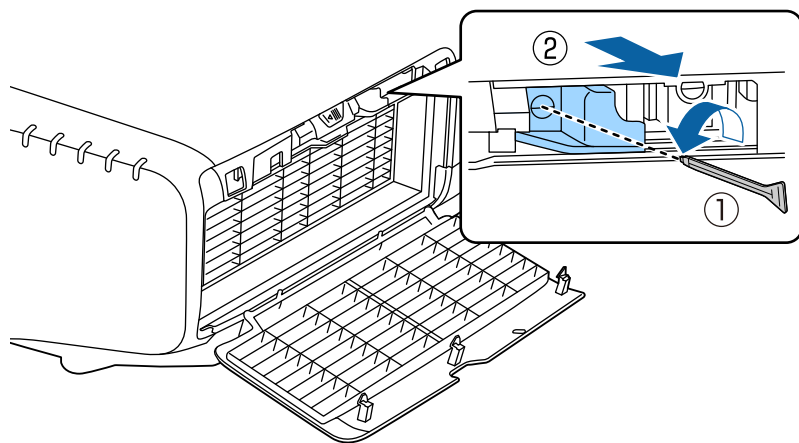

- 3** Install the Wireless LAN unit.

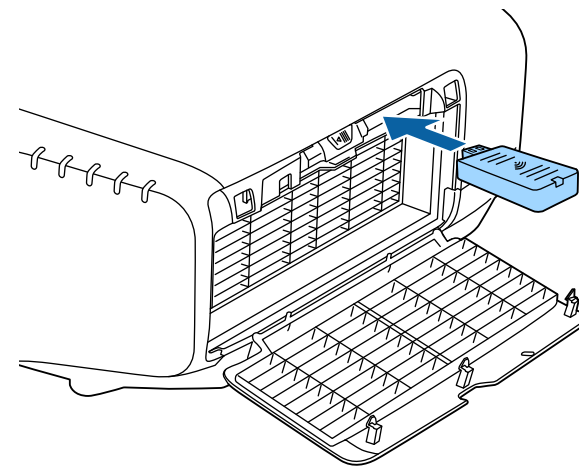

- 4** Secure the stopper with a screw.

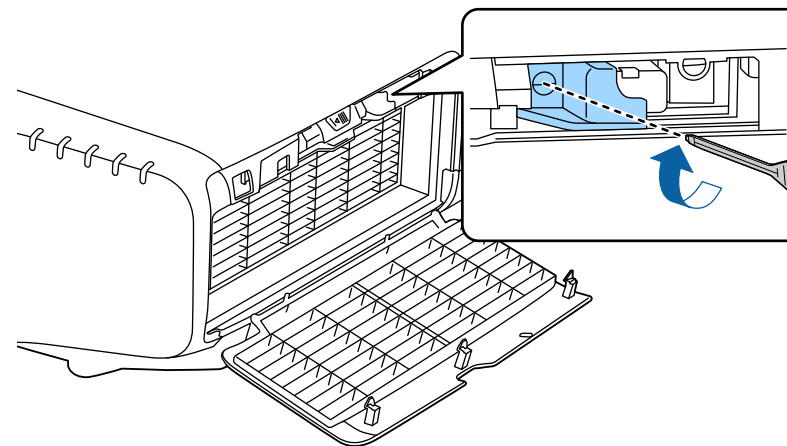

- 5** Close the air filter cover.

Using the Quick Wireless Connection USB Key

Connect the optional Quick Wireless Connection USB Key to the wireless LAN unit installation section. Check the following points when connecting a computer to the projector using wireless LAN.

- The wireless LAN unit (ELPAP10) is connected to the projector.
- The projector is setup to connect to the network using wireless LAN.
 - ☛ "Wireless LAN menu" [p.147](#)

- 1** Turn on the projector, and then press the [LAN] button on the remote control.

The following screen is displayed.

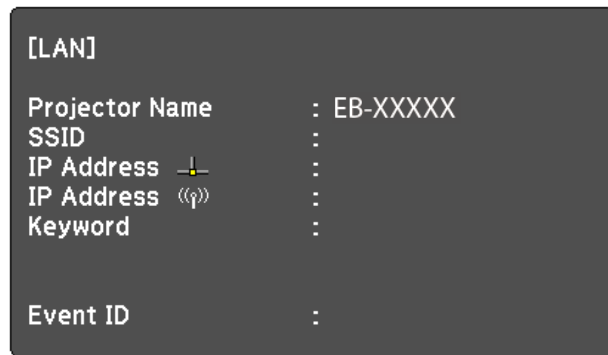

- 2** Check that the SSID and IP address information are displayed, and then remove the wireless LAN unit.
 - ☛ "Installing the Wireless LAN Unit" [p.52](#)
- 3** Insert the Quick Wireless Connection USB Key in the wireless LAN unit installation section.

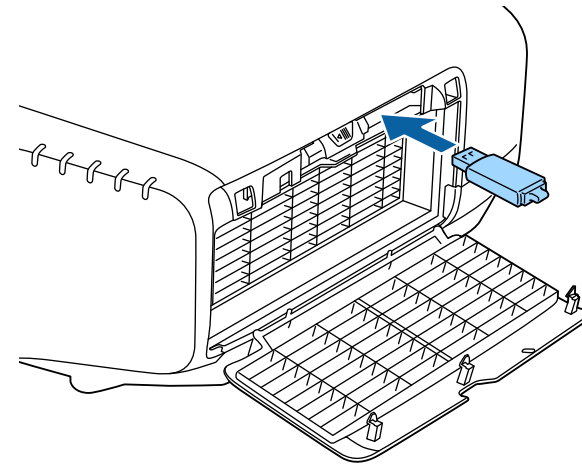

- 4** When the message "Network information update complete. Remove the Quick Wireless Connection USB Key Adapter." is displayed, remove the Quick Wireless Connection USB Key. After removing the Quick Wireless Connection USB Key, reattach the wireless LAN unit.
- 5** Connect the Quick Wireless Connection USB Key to the computer. From this point on, see the user's guide supplied with the Quick Wireless Connection USB Key.

Attaching the Cable Cover

By attaching the cable cover, you can hide the connected cables giving a nice, clean finish to the projector installation. (The illustrations are of a projector installed on a ceiling.)

Warning

Do not tie the power cord and other connection cables together. Otherwise, it could cause a fire.

Attaching

- 1** Run a commercially available cable tie through the cable holder and tie the cables together.

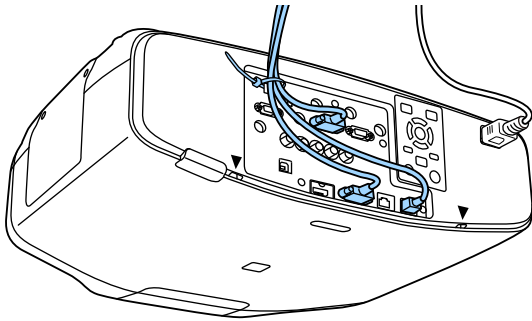

- 2** Insert the tabs on the cable cover into the two slots on the back of the projector.

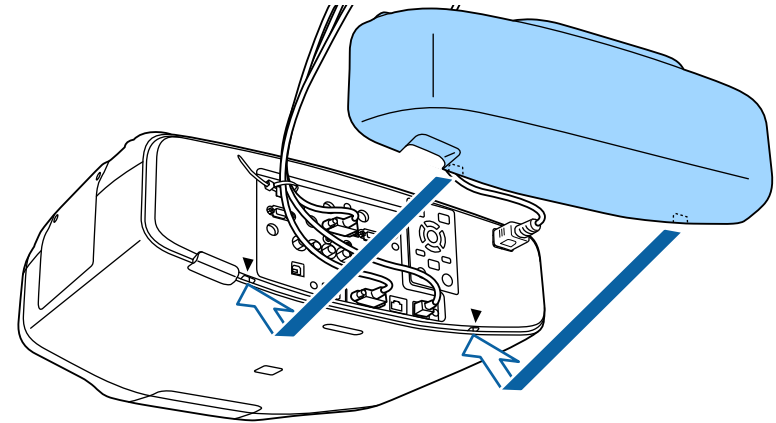

- 3** Tighten the two screws on the cable cover. (You can tighten the screws with your fingers.)

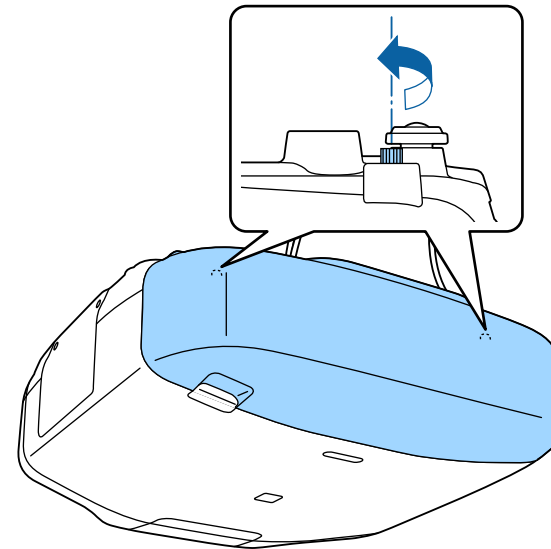



Basic Usage

This chapter explains how to project and adjust images.

Before turning on the projector, connect your computer or video equipment to the projector.

☛ "Connecting Equipment" p.46

- 1 Connect the projector to an electrical outlet with the power cord.

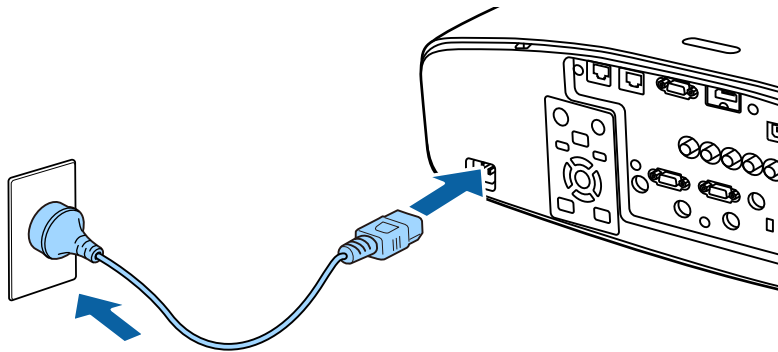

The projector's power indicator turns blue (it is in standby mode). This indicates that the projector is receiving power, but is not yet turned on.

- 2 Press the [ⓘ] button on the control panel or remote control to turn on the projector.

The confirmation buzzer beeps and the status indicator flashes blue as the projector warms up. Once the projector is warmed up, the status indicator stops flashing and turns blue.

If the image is not projected, try the following.

- Turn on the connected computer or video equipment.
- When using a laptop computer, change the screen output of the computer.
- Insert media such as a DVD and play it back.
- Press the [Search] button on the control panel or the remote control to detect the input source.
- Press the button for the input source that you want to project by using the remote control.

- If the Home screen is displayed, select the input source that you want to project.

Warning

- Do not look into the projector's lens during projection. Doing so may damage your eyes. Be especially careful if children are present.
 - During projection, do not block the light from the projector with a book and so on. If the light from the projector is blocked for a long time, the area on which the light shines becomes hot which could cause it to melt, burn, or start a fire. Also, the lens may get hot due to the reflected light which could cause the projector to malfunction. To stop projection, use the A/V Mute function or turn off the projector.
 - A mercury lamp with high internal pressure is used as the projector's light source. If the lamp is subjected to vibrations, shocks, or if it is used for an overly extended length of time, the lamp may explode with a loud noise or it may not turn on. If the lamp explodes, gases may escape and small fragments of glass may be scattered which could cause an injury. Be sure to observe the instructions below.
 - Do not disassemble or damage the lamp or subject it to any impact.
 - Do not bring your face close to the projector while it is in use.
 - Particular care should be taken when you must clean or replace the lamps by yourself, as small pieces of glass may injure you or enter your eyes or mouth. (When you open the lamp cover, small shards of glass could fall out.)
- If the lamp explodes, ventilate the area immediately, and contact a doctor if any fragments of broken glass are inhaled or get into the eyes or mouth. In addition, consult your local regulations regarding proper disposal and do not place in the trash.



- If **Direct Power On** is set to **On** in the **Extended** menu, the projector automatically turns on when the power cord is connected to it. When the power cord is plugged in, note that the projector turns on automatically in cases such as recovery from a power outage.
 - ☛ **Extended - Operation - Direct Power On** p.140
- If an image signal from the source selected in **Auto Power On** is input, the projector automatically turns on.
 - ☛ **Extended - Operation - Auto Power On** p.140

Home screen

You can use the Home screen to easily select input sources or frequently used functions. The Home screen is displayed in the following situations.

- When the [**Home**] button on the remote control is pressed
- When the projector is turned on while **Home Screen Auto Disp.** is set to **On**
 - ☛ **Extended - Home Screen - Home Screen Auto Disp.** p.140
- When there is no signal from the selected input source when the projector is turned on

When the Home screen is displayed, use the [**Up**][**Down**][**Left**][**Right**] buttons on the control panel or remote control to select an item, and then press the [**Enter**] button.

To hide the Home screen, press the [**Home**] button on the remote control again.

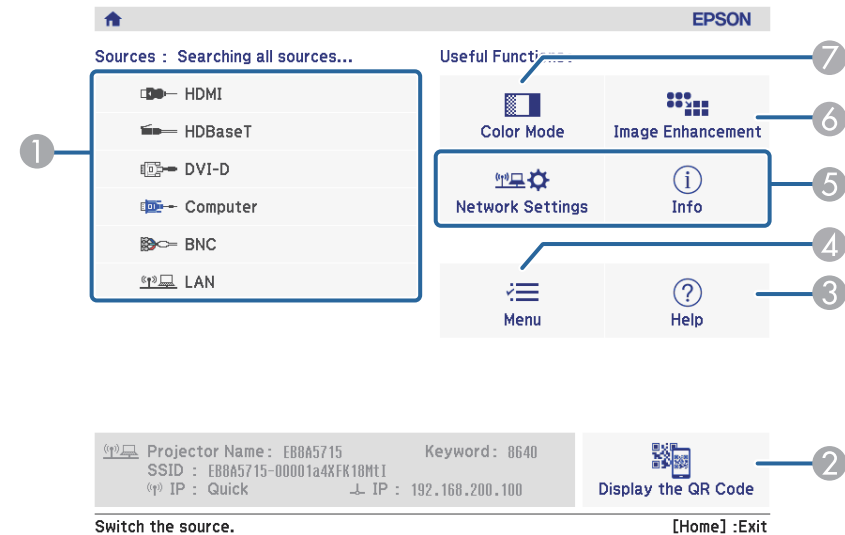

①	Select the input source that you want to project.
②	Displays the QR code and projects the data of a smartphone or tablet.
③	Displays the Help screen. ☛ "Using the Help" p.162
④	Displays the Configuration menu.
⑤	Executes the function assigned to Custom Function 1 or Custom Function 2 in the Extended menu. ☛ Extended - Home Screen - Custom Function 1, Custom Function 2 p.140
⑥	You can adjust the image resolution. ☛ "Adjusting Image Resolution (Image Enhancement)" p.95
⑦	Select a color mode. ☛ "Selecting the Projection Quality (Selecting Color Mode)" p.86



The Home screen disappears after 10 minutes of inactivity.



- To ensure a long projector service life, turn off the projector when you are not using it. The lamp's operating life varies depending on the Configuration menu settings, environmental conditions, and usage conditions. The brightness of the projected image drops as projection time elapses.
- The projector can be powered off directly by the breaker because it supports the direct shutdown function.

- 1** Press the [⏻] button on the control panel or the remote control.
The shutdown confirmation screen is displayed.

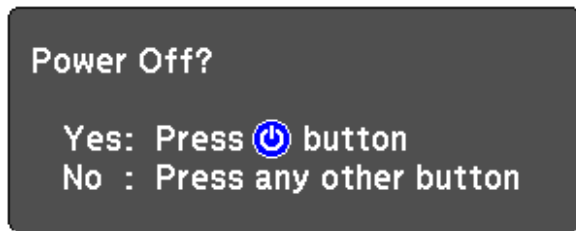

- 2** Press the [⏻] button again. (To cancel, press any other button.)
After the buzzer beeps twice, the projected image disappears, and the status indicator turns off.

- 3** Disconnect the power cord.

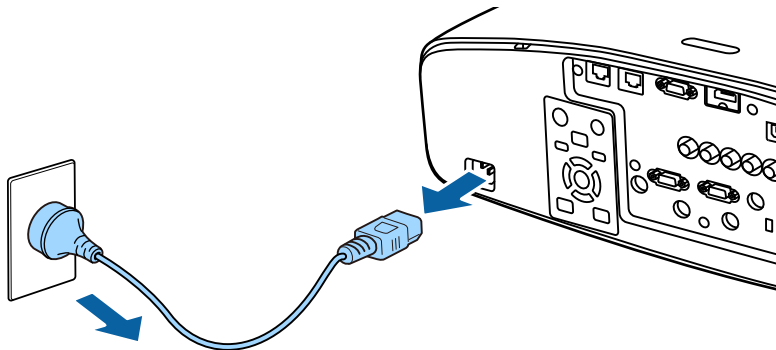

Automatically Detecting Input Signals and Changing the Projected Image (Source Search)

Press the [Search] button to project images from the port currently receiving an image.

Using the remote control

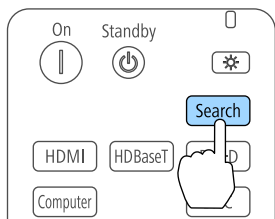

Using the control panel

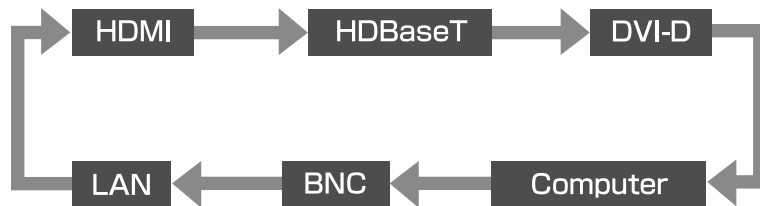
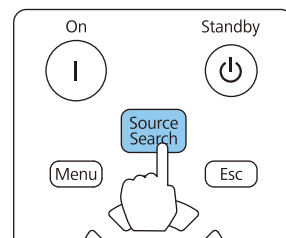

When two or more image sources are connected, repeatedly press the [Search] button until the target image is projected.

When your video equipment is connected, start playback before beginning this operation.



- You can set up the projector so that it automatically detects an image signal from another input source and projects the image when there is no image signal from the current input source.
 - Extended - Operation - Auto Source Search [p.140](#)
- The following screen is displayed while no image signals are input.

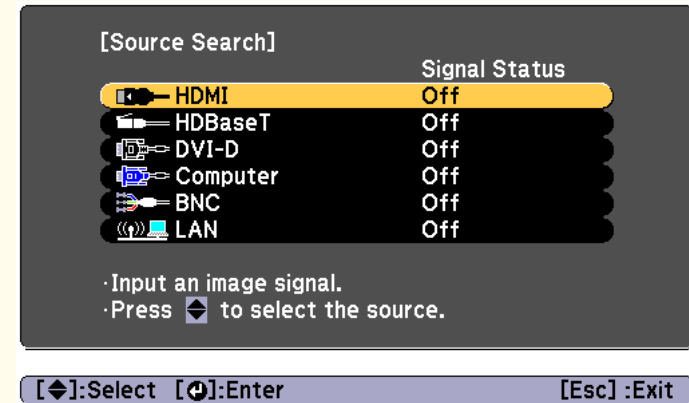

Switching to the Target Image by Remote Control

- Press the button of the input source that you want to project.
The input ports for the buttons are shown below.

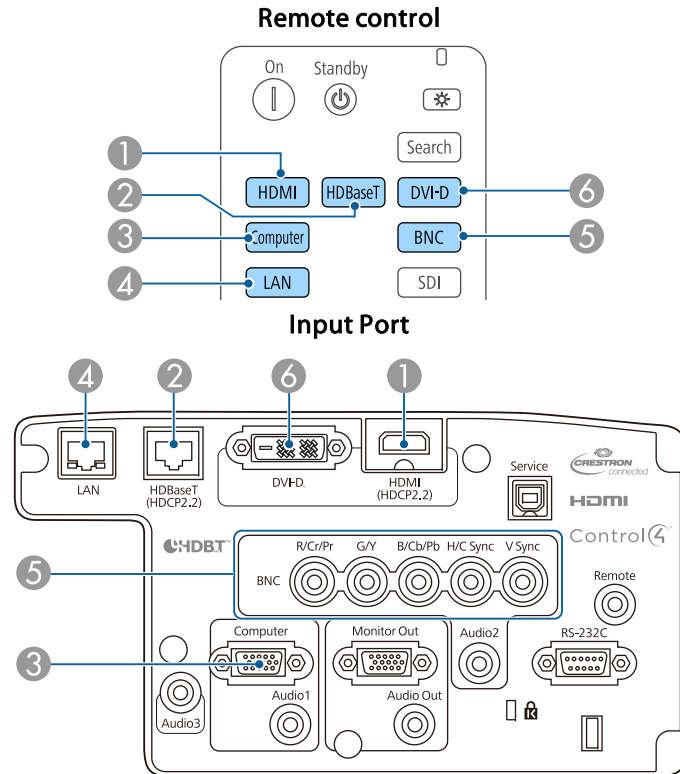

- ④ Changes to images from a computer connected via the network.

- Press the [🏠] button.

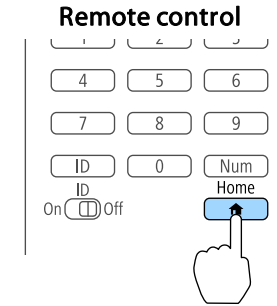

Select the input source to be projected, and then press the [↩] button.

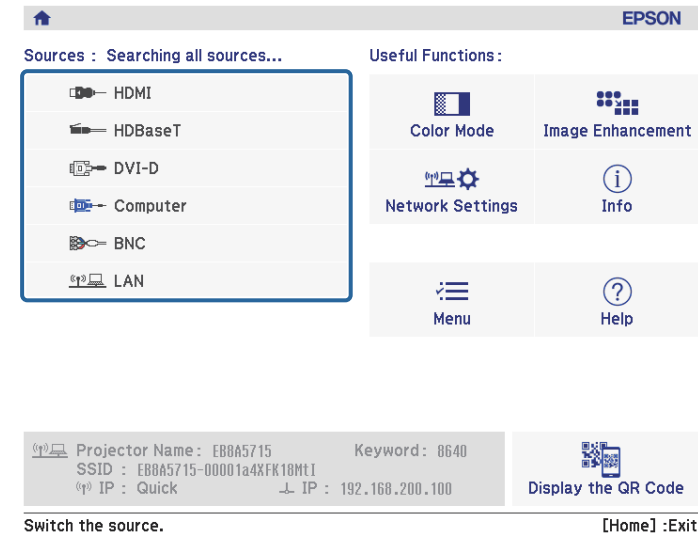

Switch the source.

[Home] :Exit

Adjusting the Volume

You can adjust the volume using one of the following methods.

- Press the [Volume] buttons on the remote control to adjust the volume.
[🔊] Decreases the volume.
[🔊] Increases the volume.

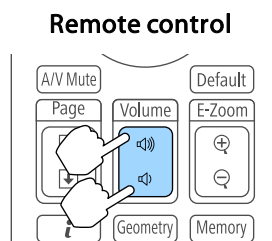

- Adjust the volume from the Configuration menu.
☛ **Settings - Volume** [p.138](#)

Caution

Do not start at high volume.
A sudden excessive volume may cause loss of hearing. Always lower the volume before powering off, so that you can power on and then gradually increase the volume.

Correcting Distortion in the Projected Image

You can correct keystone distortion in projected images using one of the following methods.

- H/V-Keystone
Correct distortion in the horizontal and vertical directions independently.
☛ "H/V-Keystone" [p.63](#)

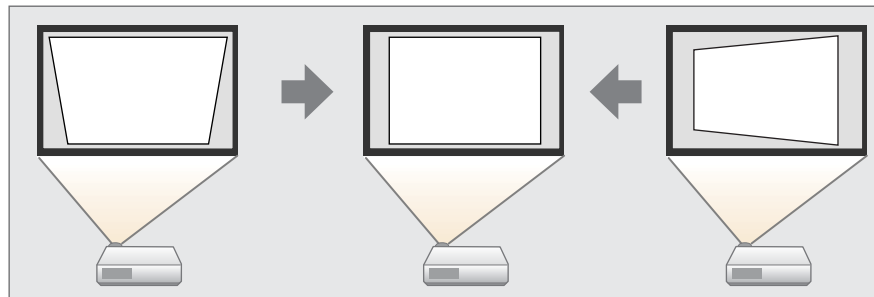

- Quick Corner
Correct the four corners independently.
☛ "Quick Corner" [p.64](#)

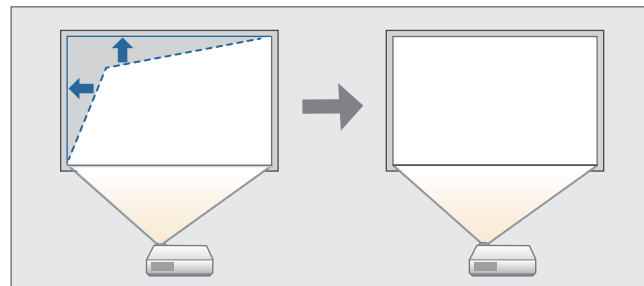

- Curved Surface
Correct distortion that occurs when projecting on a curved surface, and adjust the amount of expansion and contraction.
☛ "Curved Surface" [p.65](#)

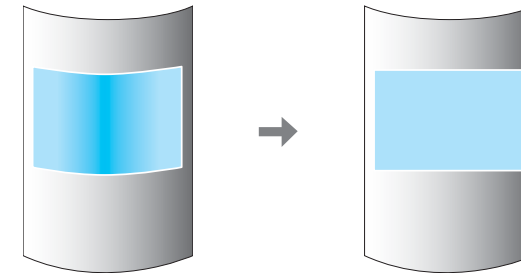

- Corner Wall
Correct distortion that occurs when projecting on a surface with right angles, such as a square pillar or the corner of a room, and adjust the amount of expansion and contraction.
☛ "Corner Wall" [p.75](#)

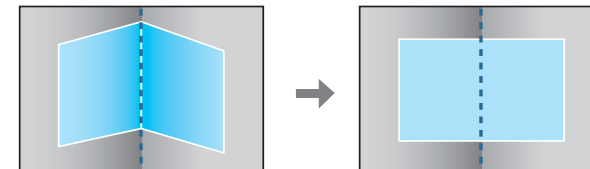

- Point Correction
Corrects slight distortion which occurs partially, or adjusts the image position in an overlapping area when projecting from multiple projectors.
☛ "Point Correction" [p.84](#)

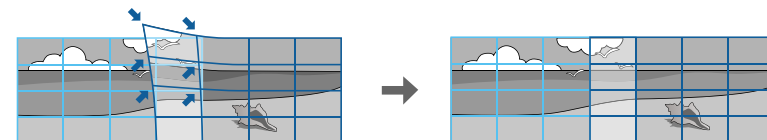



- By pressing the [Geometry] button on the remote control or the [] button on the control panel, you can perform the selected adjustment method directly.
- When you want to re-adjust the projection position and so on, if you want to release the correction status temporarily, set the **Geometric Correction** to **Off**. Even when it is set to **Off**, the correction values are saved.
 - ☛ **Settings - Geometric Correction** p.138
- You can save the geometric correction settings using **Memory** in **Geometric Correction**, and load them when needed.
 - ☛ "Memory Function" p.121

H/V-Keystone

This allows you to correct distortion in the horizontal and vertical directions independently. The correction ranges are as follows.

Lens type	Vertical	Horizontal
ELPLM08*	-45° to 45°	-30° to 30°
ELPLX01	-16° to 16°	-16° to 16°
ELPLU03	-28° to 28°	-28° to 28°
ELPLU04/ELPLU02	-35° to 35°	-30° to 30°
ELPLR04	-34° to 34°	-30° to 30°
ELPLW05	-40° to 40°	-30° to 30°
ELPLW06/ELPLW04	-45° to 45°	-30° to 30°
ELPLM09/ELPLS04	-45° to 45°	-30° to 30°
ELPLM10/ELPLM06	-45° to 45°	-30° to 30°
ELPLM11/ELPLM07	-45° to 45°	-30° to 30°
ELPLL08/ELPLL07	-45° to 45°	-30° to 30°

* The lens equipped to models with lenses.

- 1 Press the [Menu] button while projecting.
- 2 Select **Geometric Correction** from **Settings**.
- 3 Select **H/V-Keystone**, and then press the [↵] button.

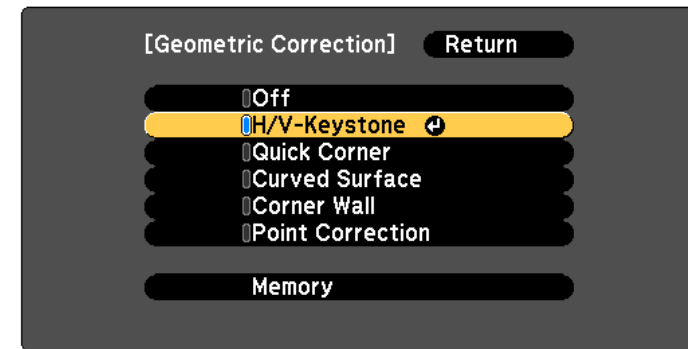

[Esc]:Return [◆]:Select [⏎]:Enter [Menu]:Exit

If the message "If this setting is changed, the image may be distorted." is displayed, press the [↵] button.

- 4 Use the [▲][▼] buttons to select the correction method, and then use the [◀][▶] buttons to make the corrections.

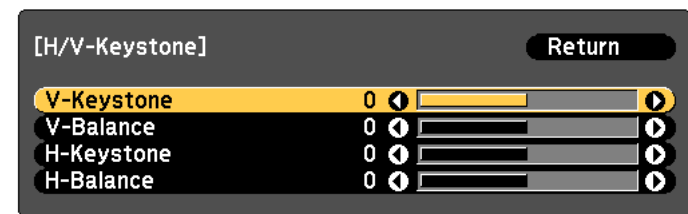

[Esc]:Return [◆]:Select [↔]:Adjust [Menu]:Exit
[Default]:Reset

Correct the keystone distortion by using **V-Keystone** and **H-Keystone**.

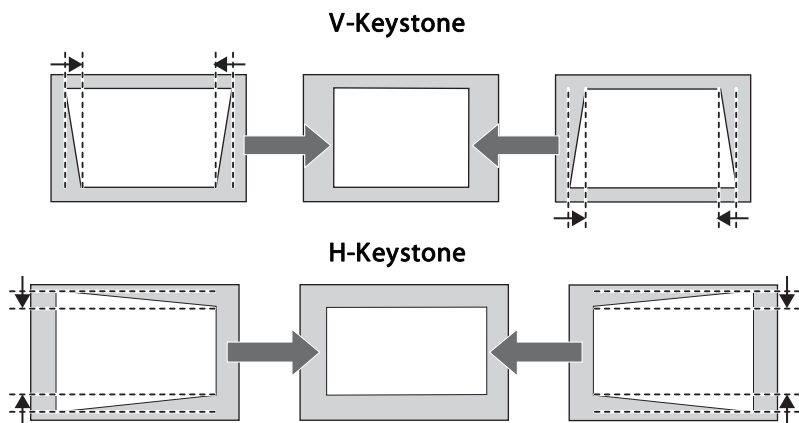

If the image aspect is incorrect, adjust the image balance by using **V-Balance** and **H-Balance**.

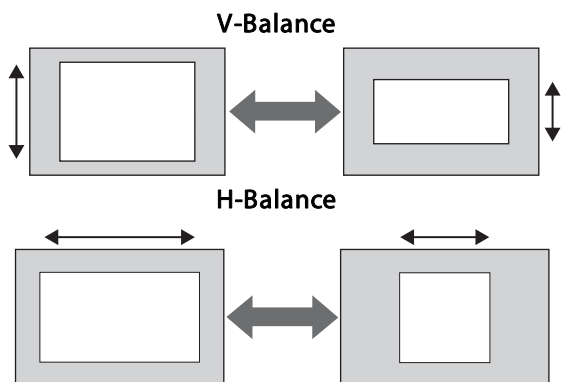

When you correct keystone distortion, the projected image may be reduced.

5 To complete the corrections, press the [Menu] button.



You cannot combine with other correction methods.

Quick Corner

This allows you to correct each of the four corners of the projected image independently.

- 1** Press the [Menu] button while projecting.
- 2** Select **Geometric Correction** from **Settings**.
- 3** Select **Quick Corner**, and then press the [↵] button.

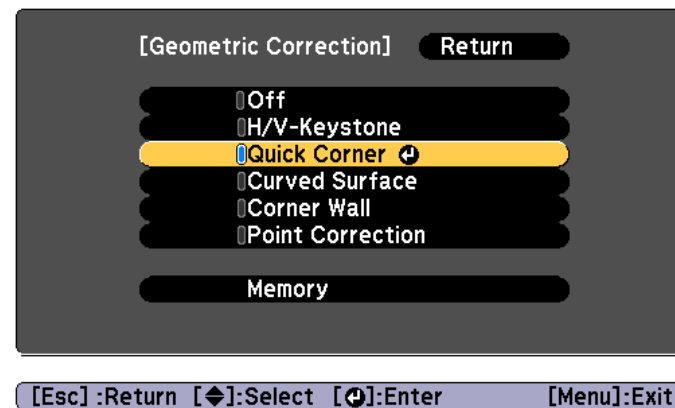

If the message "If this setting is changed, the image may be distorted." is displayed, press the [↵] button.

- 4** Use the [▲], [▼], [◀], and [▶] buttons to select the corner you want to adjust, and then press the [↵] button.

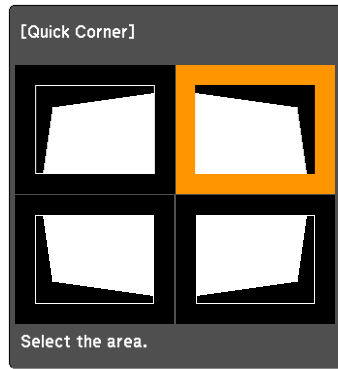

[↔/↔]:Select
 [↵]:Enter
 [Esc] : Return (press for 2 seconds to reset)



If the [Esc] button is pressed for approximately two seconds, the confirm default reset screen is displayed.
 Select **Yes** to reset the result of Quick Corner corrections.

5 Use the [▲], [▼], [◀], and [▶] buttons to correct the position of the corner.

When you press the [↵] button, the screen shown in step 5 that allows you to select the area to be corrected is displayed.

If the message "Cannot adjust any further." is displayed while adjusting, you cannot adjust the shape any further in the direction indicated by the gray triangle.

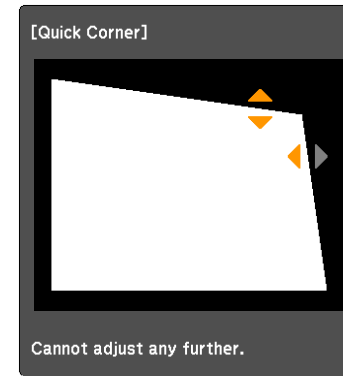

[↔/↔]:Adjust
 [Esc] / [↵]:Return

6 Repeat steps 4 and 5 as needed to adjust any remaining corners.

7 To complete the corrections, press the [Menu] button.

Curved Surface

This allows you to correct distortion that occurs when projecting on a curved surface, and adjust the amount of expansion and contraction.

Face the projector directly opposing the screen with the lens position moved to the home position.

☛ "Adjusting the Position of the Projected Image (Lens Shift)" [p.33](#)



- Project onto an arc surface with the same radius.
- If a large amount of adjustment is performed, the focus may not be uniform even after making adjustments.
- If **4K Enhancement** is enabled, a message is displayed. Select **Yes** to disable **4K Enhancement**. (EB-G7900U/EB-G7400U only)
 - ☛ **Image - Image Enhancement - 4K Enhancement** [p.135](#)

Correction range

The correction ranges are indicated in the following tables. The lens for projectors with built-in lens is ELPLM08.

EB-G7900U/EB-G7400U/EB-G7200W/EB-G7000W

Horizontally curved surface (concave)

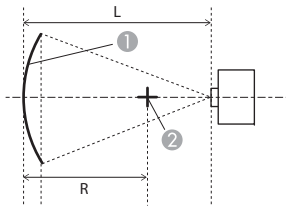



Top view

- ① Screen
 - ② Center of the circle of which the curved surface is an arc
- L Projection distance
R Radius of the circle of which the curved surface is an arc

The minimum values of R/L in the figure above are indicated in the table below.

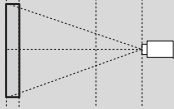
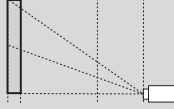
(Approximate value when projecting at maximum zoom. ELPLR04 does not support lens shift.)

Lens type	Vertical lens shift: Home position  Side view	Vertical lens shift: Top  Side view
ELPLM08	0.29	0.30
ELPLX01	-	2.74
ELPLU03	0.45	0.56
ELPLU04/ELPLU02	0.39	0.40
ELPLR04	0.37	-
ELPLW05	0.35	0.37

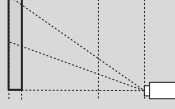
Lens type	Vertical lens shift: Home position  Side view	Vertical lens shift: Top  Side view
ELPLW06/ELPLW04	0.26	0.27
ELPLM09/ELPLS04	0.21	0.22
ELPLM10/ELPLM06	0.15	0.15
ELPLM11/ELPLM07	0.11	0.11
ELPLL08/ELPLL07	0.08	0.08

Horizontally curved surface (convex)

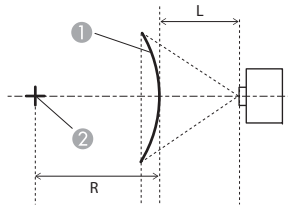

Top view

- ① Screen
- ② Center of the circle of which the curved surface is an arc
- L Projection distance
- R Radius of the circle of which the curved surface is an arc

The minimum values of R/L in the figure above are indicated in the table below.

(Approximate value when projecting at maximum zoom. ELPLR04 does not support lens shift.)

Lens type	Vertical lens shift: Home position	Vertical lens shift: Top
ELPLM08	0.58	0.62
ELPLX01	-	8.45
ELPLU03	2.13	2.31
ELPLU04/ELPLU02	1.27	1.37
ELPLR04	1.10	-
ELPLW05	0.95	1.01
ELPLW06/ELPLW04	0.49	0.52
ELPLM09/ELPLS04	0.33	0.35
ELPLM10/ELPLM06	0.20	0.20
ELPLM11/ELPLM07	0.13	0.13

Lens type	Vertical lens shift: Home position	Vertical lens shift: Top
ELPLL08/ELPLL07	0.09	0.09

Vertically curved surface (concave)

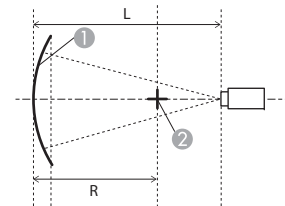

Side view

- ① Screen
- ② Center of the circle of which the curved surface is an arc
- L Projection distance
- R Radius of the circle of which the curved surface is an arc

The minimum values of R/L in the figure above are indicated in the table below.

(Approximate value when projecting at maximum zoom. ELPLR04 does not support lens shift.)

Lens type	Vertical lens shift: Home position	Vertical lens shift: Top
ELPLM08	0.21	0.25
ELPLX01	-	1.99

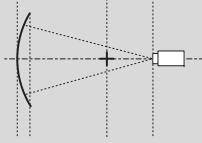
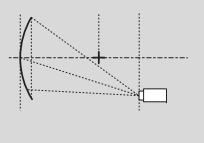
Lens type	Vertical lens shift: Home position	Vertical lens shift: Top
		
	Side view	Side view
ELPLU03	0.37	0.68
ELPLU04/ELPLU02	0.31	0.44
ELPLR04	0.29	-
ELPLW05	0.27	0.35
ELPLW06/ELPLW04	0.19	0.22
ELPLM09/ELPLS04	0.15	0.17
ELPLM10/ELPLM06	0.11	0.11
ELPLM11/ELPLM07	0.08	0.08
ELPLL08/ELPLL07	0.06	0.06

Vertically curved surface (convex)

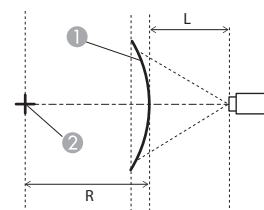

- ① Screen
- ② Center of the circle of which the curved surface is an arc
- L Projection distance
- R Radius of the circle of which the curved surface is an arc

Side view

The minimum values of R/L in the figure above are indicated in the table below.
 (Approximate value when projecting at maximum zoom. ELPLR04 does not support lens shift.)

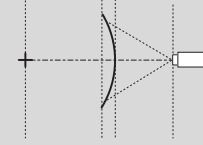
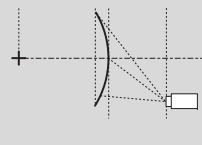
Lens type	Vertical lens shift: Home position	Vertical lens shift: Top
		
	Side view	Side view
ELPLM08	0.31	0.37
ELPLX01	-	4.16
ELPLU03	1.07	1.29
ELPLU04/ELPLU02	0.66	0.79
ELPLR04	0.57	-
ELPLW05	0.49	0.59
ELPLW06/ELPLW04	0.26	0.32
ELPLM09/ELPLS04	0.18	0.22
ELPLM10/ELPLM06	0.12	0.13

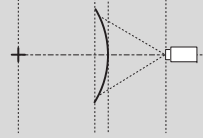
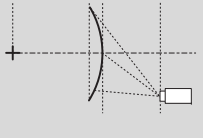
Lens type	Vertical lens shift: Home position	Vertical lens shift: Top
	 Side view	 Side view
ELPLM11/ELPLM07	0.08	0.09
ELPLL08/ELPLL07	0.06	0.06

EB-G7800

Horizontally curved surface (concave)

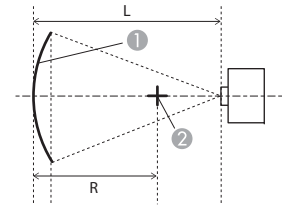

- ① Screen
- ② Center of the circle of which the curved surface is an arc
- L Projection distance
- R Radius of the circle of which the curved surface is an arc

Top view

The minimum values of R/L in the figure above are indicated in the table below.

(Approximate value when projecting at maximum zoom. ELPLR04 does not support lens shift.)

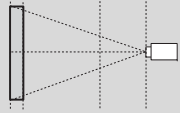
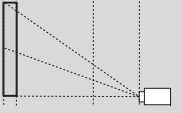
Lens type	Vertical lens shift: Home position	Vertical lens shift: Top
	 Side view	 Side view
ELPLM08	0.27	0.27
ELPLX01	-	1.66
ELPLU03	0.44	0.60
ELPLU04/ELPLU02	0.37	0.40
ELPLR04	0.35	-
ELPLW05	0.33	0.34
ELPLW06/ELPLW04	0.25	0.25
ELPLM09/ELPLS04	0.20	0.20
ELPLM10/ELPLM06	0.14	0.14

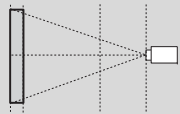
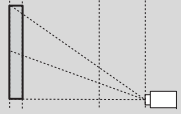
Lens type	Vertical lens shift: Home position	Vertical lens shift: Top
	 Side view	 Side view
ELPLM11/ELPLM07	0.11	0.11
ELPLL08/ELPLL07	0.08	0.08

Horizontally curved surface (convex)

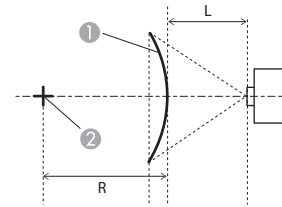

- ① Screen
- ② Center of the circle of which the curved surface is an arc
- L Projection distance
- R Radius of the circle of which the curved surface is an arc

Top view

The minimum values of R/L in the figure above are indicated in the table below.

(Approximate value when projecting at maximum zoom. ELPLR04 does not support lens shift.)

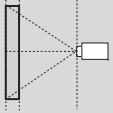
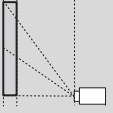
Lens type	Vertical lens shift: Home position	Vertical lens shift: Top
	 Side view	 Side view
ELPLM08	0.52	0.54
ELPLX01	-	6.48
ELPLU03	1.81	1.88
ELPLU04/ELPLU02	1.10	1.14
ELPLR04	0.97	-
ELPLW05	0.83	0.86
ELPLW06/ELPLW04	0.44	0.45
ELPLM09/ELPLS04	0.31	0.31
ELPLM10/ELPLM06	0.19	0.19
ELPLM11/ELPLM07	0.12	0.13

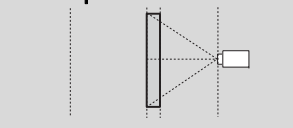
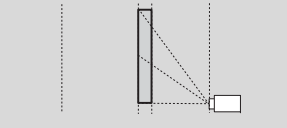
Lens type	Vertical lens shift: Home position	Vertical lens shift: Top
	 Side view	 Side view
ELPLL08/ELPLL07	0.09	0.09

Vertically curved surface (concave)

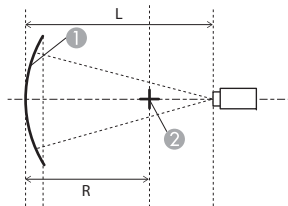

Side view

- ① Screen
- ② Center of the circle of which the curved surface is an arc
- L Projection distance
- R Radius of the circle of which the curved surface is an arc

The minimum values of R/L in the figure above are indicated in the table below.

(Approximate value when projecting at maximum zoom. ELPLR04 does not support lens shift.)

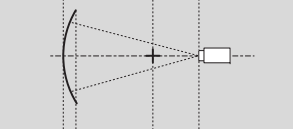
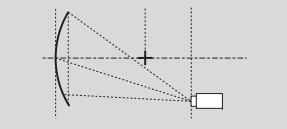
Lens type	Vertical lens shift: Home position	Vertical lens shift: Top
	 Side view	 Side view
ELPLM08	0.22	0.28
ELPLX01	-	1.73

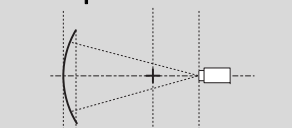
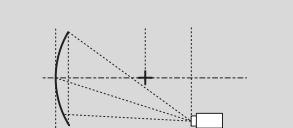
Lens type	Vertical lens shift: Home position	Vertical lens shift: Top
	 Side view	 Side view
ELPLU03	0.37	0.63
ELPLU04/ELPLU02	0.32	0.45
ELPLR04	-	0.30
ELPLW05	0.28	0.38
ELPLW06/ELPLW04	0.20	0.25
ELPLM09/ELPLS04	0.16	0.19
ELPLM10/ELPLM06	0.11	0.13
ELPLM11/ELPLM07	0.08	0.09
ELPLL08/ELPLL07	0.06	0.07

Vertically curved surface (convex)

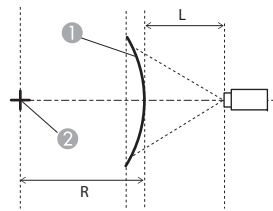

Side view

- ① Screen
- ② Center of the circle of which the curved surface is an arc
- L Projection distance
- R Radius of the circle of which the curved surface is an arc

The minimum values of R/L in the figure above are indicated in the table below.

(Approximate value when projecting at maximum zoom. ELPLR04 does not support lens shift.)

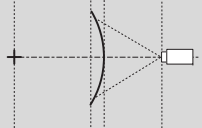
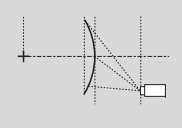
Lens type	Vertical lens shift: Home position	Vertical lens shift: Top
		
	Side view	Side view
ELPLM08	0.34	0.44
ELPLX01	-	5.36
ELPLU03	1.08	1.57
ELPLU04/ELPLU02	0.66	0.94
ELPLR04	0.59	-
ELPLW05	0.50	0.71
ELPLW06/ELPLW04	0.29	0.37
ELPLM09/ELPLS04	0.21	0.26
ELPLM10/ELPLM06	0.14	0.15

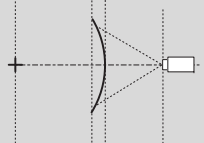
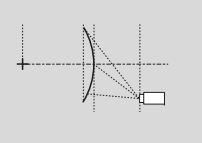
Lens type	Vertical lens shift: Home position	Vertical lens shift: Top
		
	Side view	Side view
ELPLM11/ELPLM07	0.10	0.10
ELPLL08/ELPLL07	0.07	0.07

Correction method

- 1 Press the [Menu] button while projecting.
- 2 Select **Geometric Correction** from **Settings**.
- 3 Select **Curved Surface**, and then press the [↵] button.

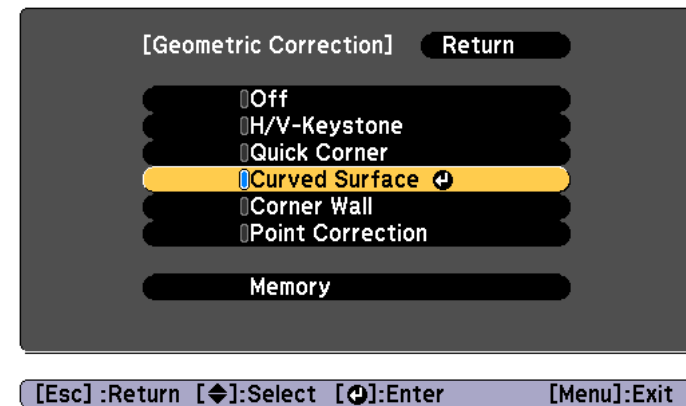

If the message "If this setting is changed, the image may be distorted." is displayed, press the [↵] button.

4 Select **Curved Surface**, and then press the [↵] button.

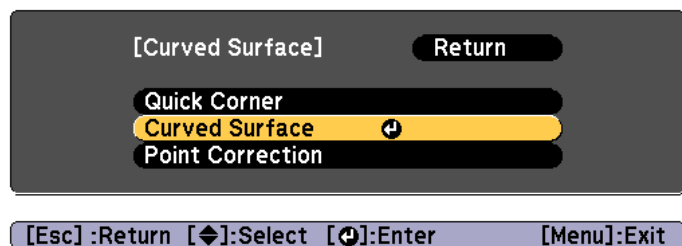

5 Select **Correct Shape**, and then press the [↵] button.

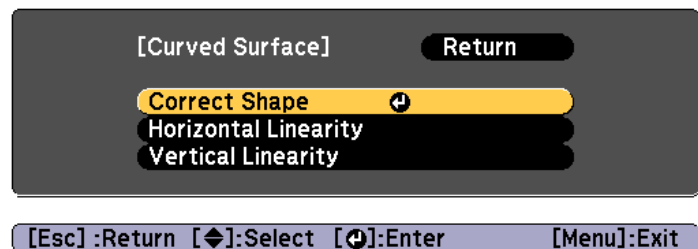

6 Use the [▲], [▼], [◀], and [▶] buttons to select the area you want to adjust, and then press the [↵] button.

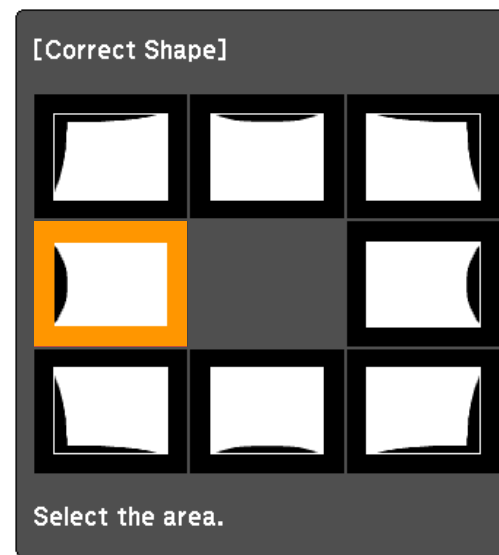

When selecting a corner, you can adjust the two sides next to the corner.

 If the [Esc] button is pressed for approximately two seconds, the confirm default reset screen is displayed. Select **Yes** to reset the result of Curved Surface.

7 Use the [▲], [▼], [◀], and [▶] buttons to adjust the shape.

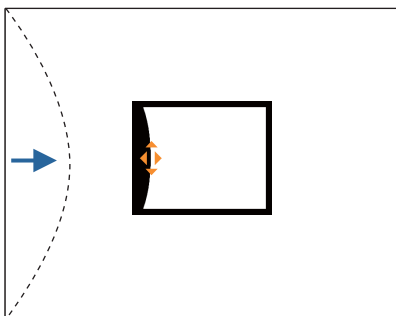

If the triangle in the direction you are adjusting the shape turns gray, as shown in the screenshot below, you cannot adjust the shape any further in that direction.

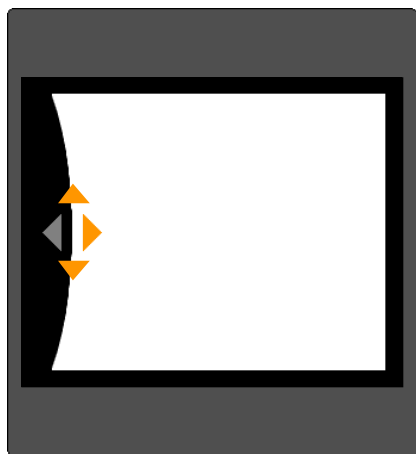

8 Press the [Esc] button to return to the previous screen.

9 Repeat steps from 6 to 8 as needed to adjust any remaining parts.

If the image expands or contracts, go to the next step and adjust the linearity.

10 Press the [Esc] button to return to the screen in step 5. Select **Horizontal Linearity** or **Vertical Linearity**, and then press the [↵] button.

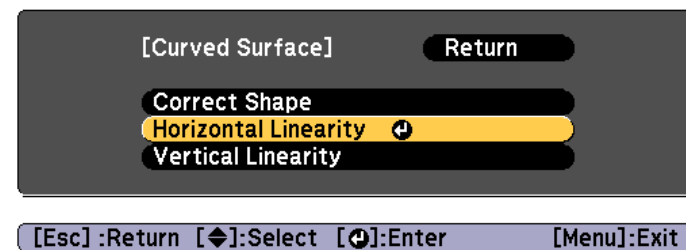

Select **Horizontal Linearity** to adjust the horizontal expansion or contraction, and select **Vertical Linearity** to adjust the vertical expansion or contraction.

11 Select the standard line for the adjustments, and then press the [↵] button.

Press the [◀][▶] buttons when selecting **Horizontal Linearity**, and the [▲][▼] buttons when selecting **Vertical Linearity**, and then press [↵].

The selected standard line is displayed in flashing orange and white.

12 Adjust the linearity.

Correct it so that the distance between lines is equal.

When pressing the [◀] button

When **Horizontal Linearity** is selected When **Vertical Linearity** is selected

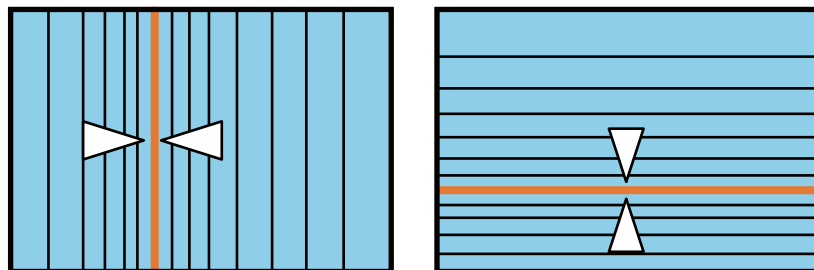

When pressing the [▶] button

When **Horizontal Linearity** is selected When **Vertical Linearity** is selected

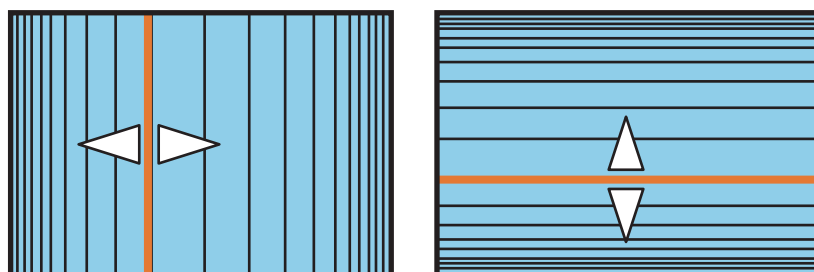

13 To complete the corrections, press the [Menu] button.



You can fine tune the corrected results. Use Quick Corner to adjust the tilt of the image, and then use Point Correction for fine tuning. Select **Quick Corner** or **Point Correction** on the screen from step 4.

☛ "Quick Corner" p.64

☛ "Point Correction" p.84

Corner Wall

This allows you to correct distortion that occurs when projecting on a surface with right angles, such as a square pillar or the corner of a room, and adjust the amount of expansion and contraction.

Face the projector directly opposing the screen with the lens position moved to the home position.

☛ "Adjusting the Position of the Projected Image (Lens Shift)" p.33



- Project onto a surface with a right angle.
- If a large amount of adjustment is performed, the focus may not be uniform even after making adjustments.
- If **4K Enhancement** is enabled, a message is displayed. Select **Yes** to disable **4K Enhancement**. (EB-G7900U/EB-G7400U only)
 - ☛ **Image - Image Enhancement - 4K Enhancement** p.135
- This is not available for ELPLX01.

Correction range

The correction range is as follows. The lens for projectors with built-in lens is ELPLM08.

EB-G7900U/EB-G7400U/EB-G7200W/EB-G7000W

Concave horizontal corner correction (correction to bilateral symmetry by using the corner as the center line)

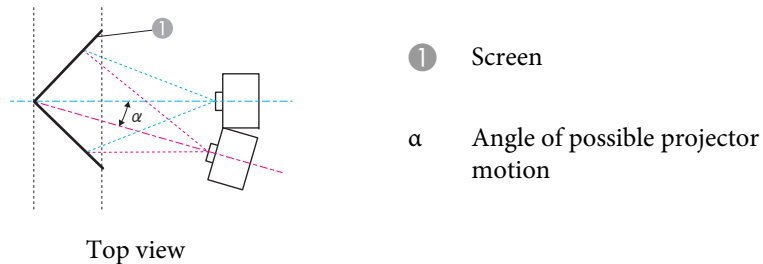

α in the figure above is the maximum angle in which the projector can move. See the table below for detailed values. (Approximate value when projecting at maximum zoom. ELPLR04 does not support lens shift.)

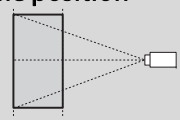
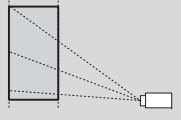
Lens type	Vertical lens shift: Home position  Side view	Vertical lens shift: Top  Side view
ELPLM08	31°	23°
ELPLX01	-	-
ELPLU03	29°	9°
ELPLU04/ELPLU02	31°	14°
ELPLR04	32°	-
ELPLW05	33°	18°
ELPLW06/ELPLW04	31°	25°
ELPLM09/ELPLS04	30°	29°
ELPLM10/ELPLM06	29°	29°
ELPLM11/ELPLM07	29°	28°

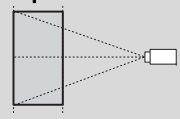
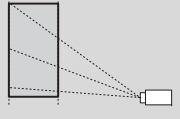
Lens type	Vertical lens shift: Home position  Side view	Vertical lens shift: Top  Side view
ELPLL08/ELPLL07	28°	28°

Convex horizontal corner correction (correction to bilateral symmetry by using corners as the center line)

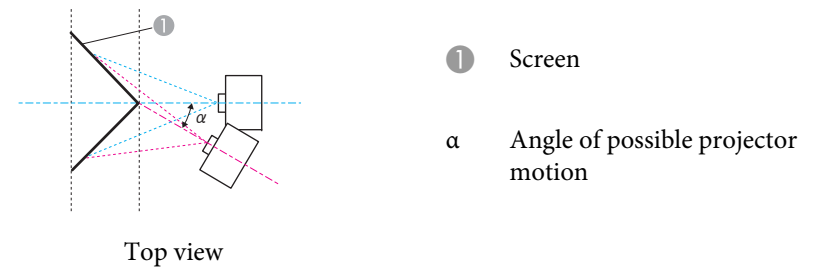

α in the figure above is the maximum angle in which the projector can move. See the table below for detailed values. (Approximate value when projecting at maximum zoom. ELPLR04 does not support lens shift.)

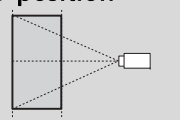
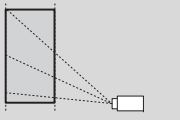
Lens type	Vertical lens shift: Home position  Side view	Vertical lens shift: Top  Side view
ELPLM08	14°	13°
ELPLX01	-	-
ELPLU03	0°	*

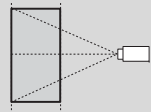
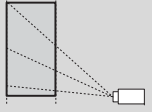
Lens type	Vertical lens shift: Home position	Vertical lens shift: Top
		
	Side view	Side view
ELPLU04/ELPLU02	6°	4°
ELPLR04	8°	-
ELPLW05	9°	8°
ELPLW06/ELPLW04	16°	15°
ELPLM09/ELPLS04	18°	18°
ELPLM10/ELPLM06	22°	21°
ELPLM11/ELPLM07	23°	23°
ELPLL08/ELPLL07	24°	24°

*Cannot be corrected accurately. Move the lens position to the home position.

Concave vertical corner correction (correction to horizontal symmetry by using corners as the center line)

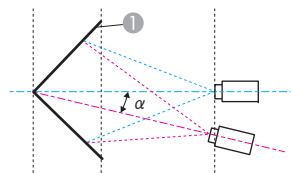

Side view

- ① Screen
- α Angle of possible projector motion

α in the figure above is the maximum angle in which the projector can move. See the table below for detailed values. (Approximate value when projecting at maximum zoom. ELPLR04 does not support lens shift.)

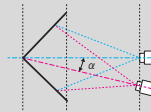
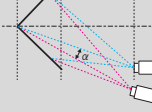
Lens type	Vertical lens shift: Home position	Vertical lens shift: Top
		
	Side view	Side view
ELPLM08	30°	12°
ELPLX01	-	-
ELPLU03	33°	*
ELPLU04/ELPLU02	31°	6°
ELPLR04	31°	-
ELPLW05	31°	10°
ELPLW06/ELPLW04	28°	13°
ELPLM09/ELPLS04	26°	14°
ELPLM10/ELPLM06	24°	16°
ELPLM11/ELPLM07	23°	18°
ELPLL08/ELPLL07	23°	19°

*Cannot be corrected accurately. Move the lens position to the home position.

Convex vertical corner correction (correction to horizontal symmetry by using corners as the center line)

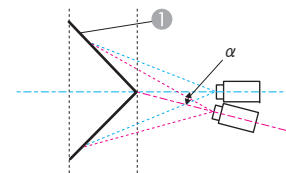

Side view

- ① Screen
- α Angle of possible projector motion

α in the figure above is the maximum angle in which the projector can move. See the table below for detailed values. (Approximate value when projecting at maximum zoom. ELPLR04 does not support lens shift.)

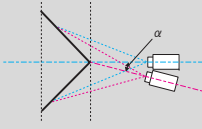
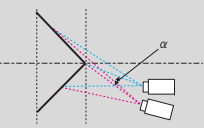
Lens type	Vertical lens shift: Home position  Side view	Vertical lens shift: Top  Side view
ELPLM08	19°	5°
ELPLX01	-	-
ELPLU03	9°	*
ELPLU04/ELPLU02	14°	*
ELPLR04	15°	-
ELPLW05	16°	*
ELPLW06/ELPLW04	20°	7°
ELPLM09/ELPLS04	22°	12°
ELPLM10/ELPLM06	22°	15°
ELPLM11/ELPLM07	22°	17°
ELPLL08/ELPLL07	22°	18°

*Cannot be corrected accurately. Move the lens position to the home position.

EB-G7800

Concave horizontal corner correction (correction to bilateral symmetry by using corners as the center line)

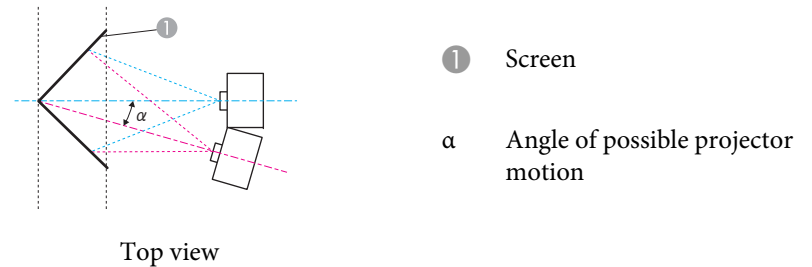

α in the figure above is the maximum angle in which the projector can move. See the table below for detailed values. (Approximate value when projecting at maximum zoom. ELPLR04 does not support lens shift.)

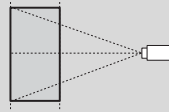
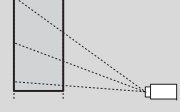
Lens type	Vertical lens shift: Home position  Side view	Vertical lens shift: Top  Side view
ELPLM08	31°	21°
ELPLX01	-	-
ELPLU03	26°	7°
ELPLU04/ELPLU02	29°	13°
ELPLR04	30°	-
ELPLW05	31°	16°
ELPLW06/ELPLW04	31°	23°
ELPLM09/ELPLS04	30°	27°
ELPLM10/ELPLM06	29°	29°
ELPLM11/ELPLM07	29°	29°

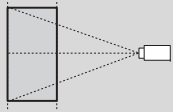
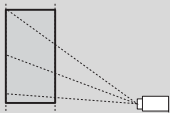
Lens type	Vertical lens shift: Home position	Vertical lens shift: Top
		
	Side view	Side view
ELPLL08/ELPLL07	28°	28°

Convex horizontal corner correction (correction to bilateral symmetry by using corners as the center line)

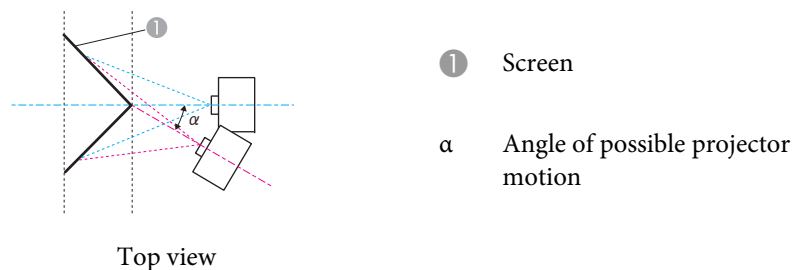

α in the figure above is the maximum angle in which the projector can move. See the table below for detailed values. (Approximate value when projecting at maximum zoom. ELPLR04 does not support lens shift.)

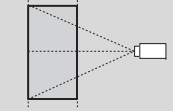
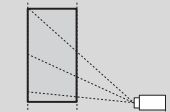
Lens type	Vertical lens shift: Home position	Vertical lens shift: Top
		
	Side view	Side view
ELPLM08	14°	14°
ELPLX01	-	-
ELPLU03	0°	*

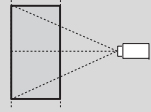
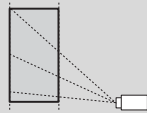
Lens type	Vertical lens shift: Home position	Vertical lens shift: Top
		
	Side view	Side view
ELPLU04/ELPLU02	6°	2°
ELPLR04	8°	-
ELPLW05	10°	7°
ELPLW06/ELPLW04	16°	16°
ELPLM09/ELPLS04	19°	18°
ELPLM10/ELPLM06	22°	21°
ELPLM11/ELPLM07	23°	23°
ELPLL08/ELPLL07	24°	24°

*Cannot be corrected accurately. Move the lens position to the home position.

Concave vertical corner correction (correction to horizontal symmetry by using corners as the center line)

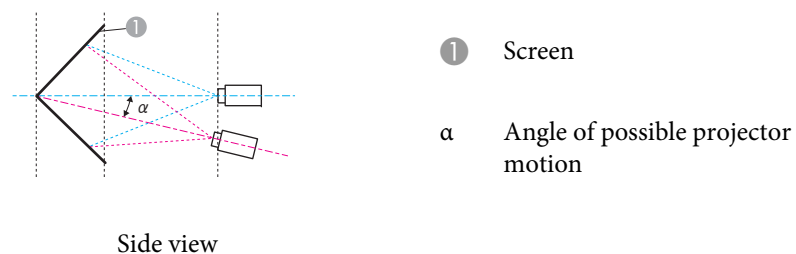

α in the figure above is the maximum angle in which the projector can move. See the table below for detailed values. (Approximate value when projecting at maximum zoom. ELPLR04 does not support lens shift.)

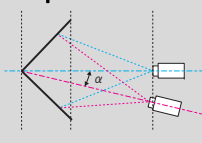
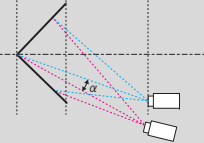
Lens type	Vertical lens shift: Home position	Vertical lens shift: Top
		
	Side view	Side view
ELPLM08	31°	14°
ELPLX01	-	-
ELPLU03	33°	*
ELPLU04/ELPLU02	32°	7°
ELPLR04	32°	-
ELPLW05	31°	10°
ELPLW06/ELPLW04	30°	16°
ELPLM09/ELPLS04	29°	17°
ELPLM10/ELPLM06	27°	19°
ELPLM11/ELPLM07	26°	21°
ELPLL08/ELPLL07	26°	22°

*Cannot be corrected accurately. Move the lens position to the home position.

Convex vertical corner correction (correction to horizontal symmetry by using corners as the center line)

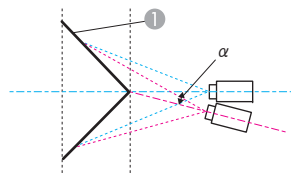

Side view

- ① Screen
- α Angle of possible projector motion

α in the figure above is the maximum angle in which the projector can move. See the table below for detailed values. (Approximate value when projecting at maximum zoom. ELPLR04 does not support lens shift.)

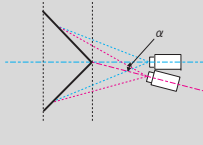
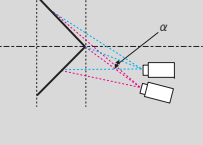
Lens type	Vertical lens shift: Home position	Vertical lens shift: Top
		
	Side view	Side view
ELPLM08	18°	4°
ELPLX01	-	-
ELPLU03	6°	*
ELPLU04/ELPLU02	12°	*
ELPLR04	13°	-
ELPLW05	14°	*
ELPLW06/ELPLW04	19°	6°
ELPLM09/ELPLS04	21°	11°
ELPLM10/ELPLM06	23°	16°
ELPLM11/ELPLM07	24°	19°
ELPLL08/ELPLL07	25°	21°

*Cannot be corrected accurately. Move the lens position to the home position.

Correction method

- 1 Press the [Menu] button while projecting.
- 2 Select **Geometric Correction** from **Settings**.
- 3 Select **Corner Wall**, and then press the [↵] button.

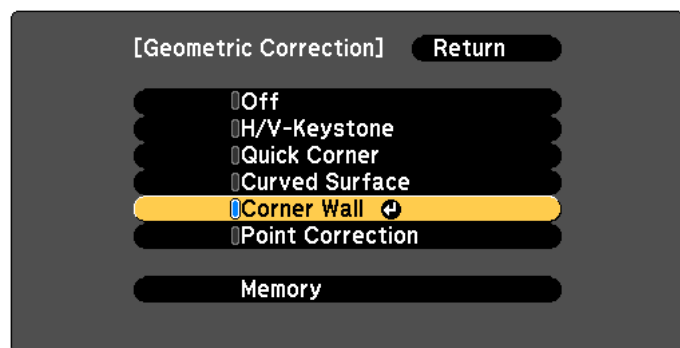

[Esc]:Return [↩]:Select [↵]:Enter [Menu]:Exit

If the message "If this setting is changed, the image may be distorted." is displayed, press the [↵] button.

- 4 Select **Corner Wall**, and then press the [↵] button.

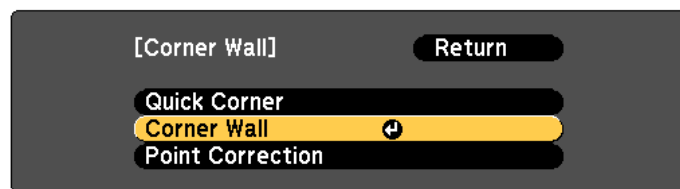

[Esc]:Return [↩]:Select [↵]:Enter [Menu]:Exit

- 5 Select **Corner Type**, and then press the [↵] button.

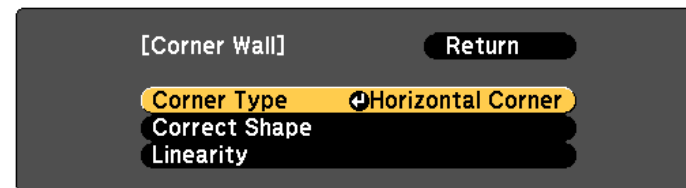

[Esc]:Return [↩]:Select [↵]:Enter [Menu]:Exit

6 According to the projection area, select **Horizontal Corner** or **Vertical Corner**, and then press the [**↵**] button.

When the surfaces line up horizontally:

Select **Horizontal Corner**.

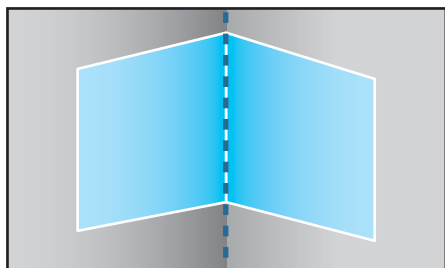

When the surfaces line up vertically:

Select **Vertical Corner**.

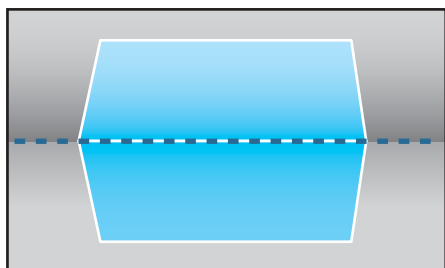

From here on, steps are explained using **Horizontal Corner** as an example.

7 Press the [Esc] button to display the screen from step 5. Select **Correct Shape**, and then press the [**↵**] button.

8 Adjust the position of the projector and the lens shift so that the line in the center of the screen matches the corner (the point where the two surfaces meet).

☛ "Adjusting the Position of the Projected Image (Lens Shift)"
[p.33](#)

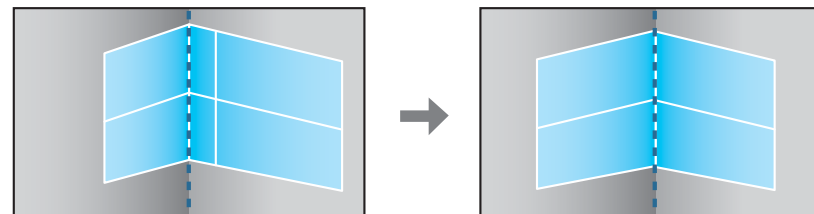

Each time you press the [**↵**] button, you can show or hide the image and the grid.

- 9** Use the [▲], [▼], [◀], and [▶] buttons to select the area you want to adjust, and then press the [↵] button.

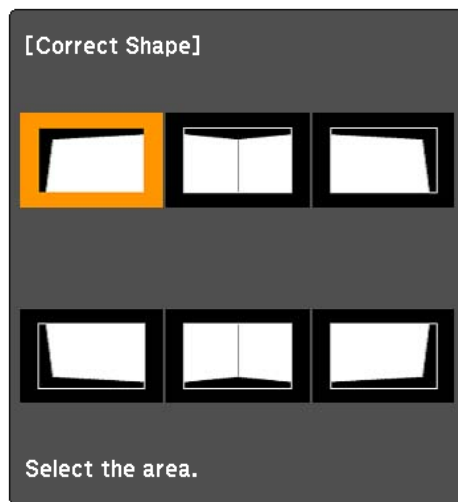

Adjustment tips

When **Horizontal Corner** is selected:

Adjust the upper area based on the lowest point (indicated by the **A** arrow).

Adjust the lower area based on the highest point (indicated by the **B** arrow).

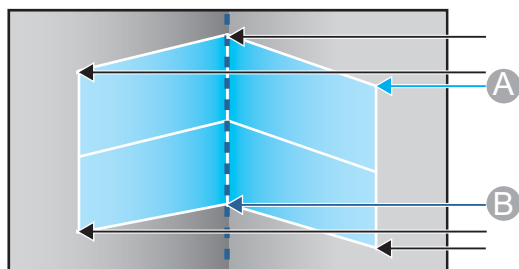

When **Vertical Corner** is selected:

Adjust the left and right based on the point nearest to the vertical line in the center of the screen.



If the [Esc] button is pressed for approximately two seconds, the confirm default reset screen is displayed.

Select **Yes** to reset the result of **Corner Wall**.

- 10** Press the [▲][▼][◀][▶] buttons to adjust the shape. If the message "Cannot adjust any further." is displayed while adjusting, you cannot adjust the shape any further in the direction indicated by the gray triangle.
- 11** Repeat steps 9 and 10 as needed to adjust any remaining parts. If the image expands or contracts, go to the next step and adjust the linearity.
- 12** Press the [Esc] button to display the screen from step 4. Select **Linearity**, and then press the [↵] button.

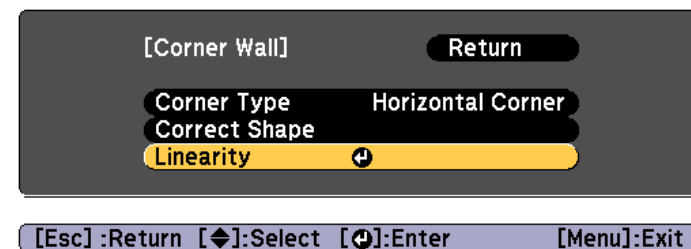

- 13** Press the [◀][▶] buttons to adjust the linearity.
Correct it so that the distance between lines is equal.

When pressing the [◀] button

When **Horizontal Corner** is selected

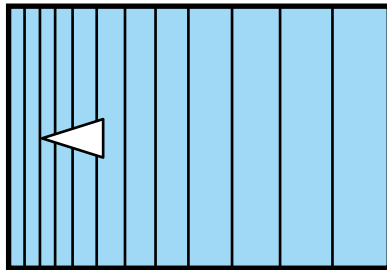

When **Vertical Corner** is selected

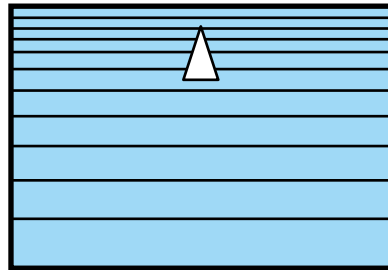

When pressing the [▶] button

When **Horizontal Corner** is selected

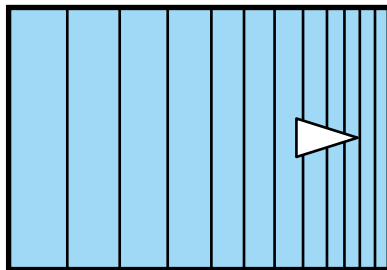

When **Vertical Corner** is selected

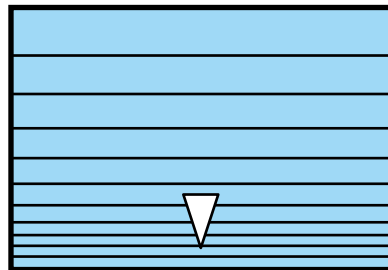

- 14** To complete the corrections, press the [Menu] button.



You can fine tune the corrected results. Use Quick Corner to adjust the tilt of the image, and then use Point Correction for fine tuning. Select **Quick Corner** or **Point Correction** on the screen from step 4.

- ☛ "Quick Corner" p.64
- ☛ "Point Correction" p.84

Point Correction

Divides the projected image by the grid and corrects the distortion by moving the point of intersection from side to side and up and down.



- You can make corrections by 0.5 pixels in each direction in the following ranges.
EB-G7900U/EB-G7400U: Maximum of 32 pixels in the vertical and horizontal directions
EB-G7200W/EB-G7000W/EB-G7800: Maximum of 20 pixels in the vertical and horizontal directions
- If **4K Enhancement** is enabled, a message is displayed. Select **Yes** to disable **4K Enhancement**. (EB-G7900U/EB-G7400U only)
☛ **Image - Image Enhancement - 4K Enhancement** p.135

- 1** Press the [Menu] button while projecting.
- 2** Select **Geometric Correction** from **Settings**.
- 3** Select **Point Correction**, and then press the [↵] button.

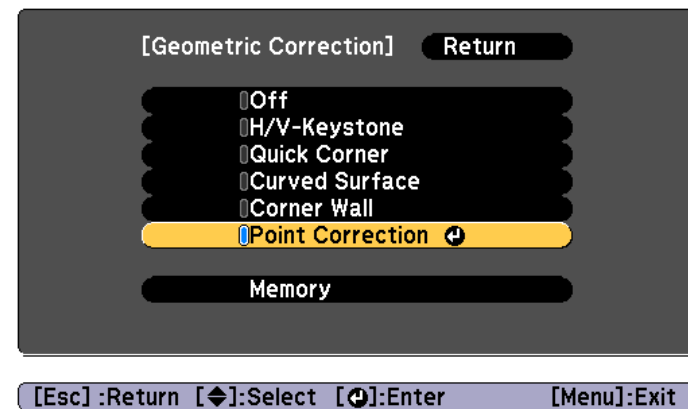

If the message "If this setting is changed, the image may be distorted." is displayed, press the [↵] button.

4 Select **Point Correction**, and then press the [**↵**] button.

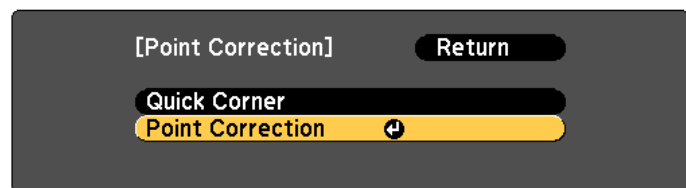

[Esc]:Return [↩]:Select [↵]:Enter [Menu]:Exit

5 Select **Point Correction**, and then press the [**↵**] button.

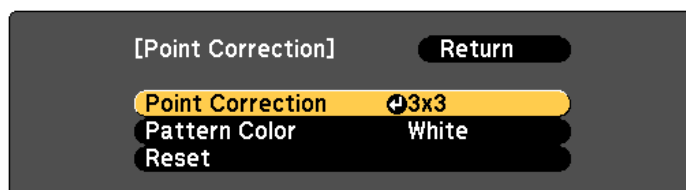

[Esc]:Return [↩]:Select [↵]:Enter [Menu]:Exit

Point Correction	Select the point number (3x3, 5x5, 9x9, 17x17), and then make the Point Correction setting.
Pattern Color	Select the color of the grid when performing corrections.
Reset	Resets all corrections for Point Correction to their default values.

6 Select the point number (**3x3**, **5x5**, **9x9**, or **17x17**), and then press the [**↵**] button.

7 Use the [**▲**], [**▼**], [**◀**], and [**▶**] buttons to move to the point you want to correct, and then press the [**↵**] button.

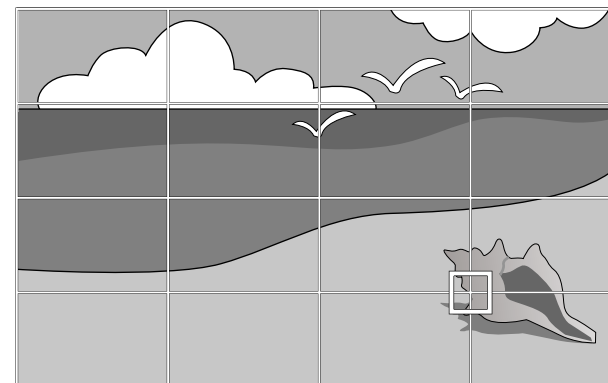

8 Use the [**▲**], [**▼**], [**◀**], and [**▶**] buttons to correct distortion.

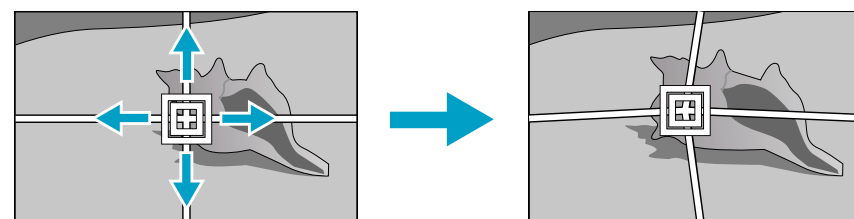

To continue to correct another point, press the [Esc] button to return to the previous screen, then repeat the steps 7 and 8.



Each time you press the [**↵**] button, you can show or hide the image and the grid.

9 To complete the corrections, press the [Menu] button.



You can fine tune the corrected results. Select **Quick Corner** on the screen from step 4 to adjust the tilt of the image.

☞ "Quick Corner" [p.64](#)

Selecting the Projection Quality (Selecting Color Mode)

You can easily obtain the optimum image quality simply by selecting the setting that best corresponds to your surroundings when projecting. The brightness of the image varies depending on the mode selected.

Mode	Application
Dynamic	This is the brightest mode. Ideal for use in a bright room.
Presentation	The images are vivid and brought to life. Ideal for making presentations or watching a TV program in a bright room.
Cinema	Gives images a natural tone. Ideal for watching films in a dark room.
sRGB	This produces the images that conform to the sRGB color standard and the colors are reproduced faithfully. Ideal for projecting still pictures such as photos.
DICOM SIM	This produces images with clear shadows. Ideal for projecting X-ray photographs and other medical images. The projector is not a medical device and cannot be used for medical diagnosis.
Multi-Projection	Minimize the color tone difference between each projected image. Ideal for projecting from multiple projectors.

Each time you press the [Color Mode] button, the Color Mode name is displayed on the screen and the Color Mode changes.

Remote control

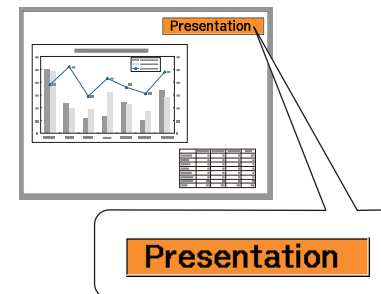
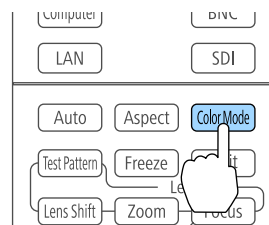

You can set Color Mode from the Configuration menu.

☞ **Image - Color Mode** [p.135](#)

Setting Auto Iris

By automatically setting the luminance according to the brightness of the displayed image, it lets you enjoy deep and rich images.



- **Auto Iris** can only be set when the **Color Mode** is set to **Dynamic** or **Cinema**.
- When **Edge Blending** is set to **On**, Auto Iris is disabled.

- 1 Press the [Menu] button while projecting.
- 2 Select **Auto Iris** from **Image**, and then press the [↵] button.

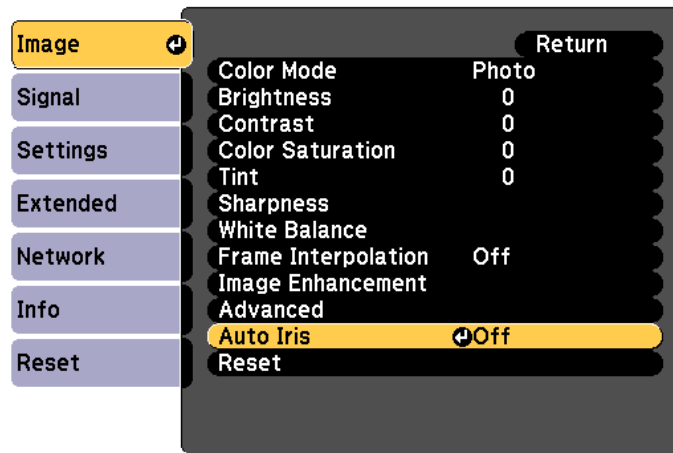

[Esc]:Return [↵]:Select [Enter]:Enter [Menu]:Exit

- 3 Select **High Speed**, and then press the [↵] button.
If you are concerned about the operation noise of Auto Iris, set it to **Normal**.
The setting is stored for each color mode.

- 4 Press the [Menu] button to finish making settings.

Changing the Aspect Ratio of the Projected Image

You can change the Aspect Ratio of the projected image to suit the type, the ratio of height and width, and the resolution of the input signals.

Available aspect modes vary depending on the Screen Type currently set.



- Set the **Screen Type** before changing the aspect ratio.
☞ "Screen Settings" p.30

Changing methods

Each time you press the [Aspect] button on the remote control, the aspect mode name is displayed on the screen and the aspect ratio changes.

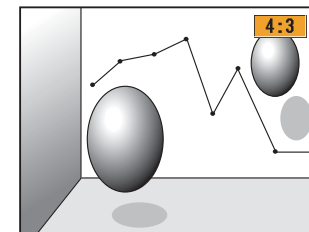
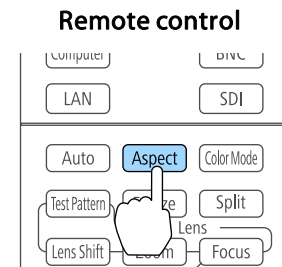

Aspect Mode	Explanation
Auto	Projects in an appropriate aspect ratio based on information from the signal being input.
Normal	Projects while retaining the aspect ratio of the input image.
4:3	Projects at an aspect ratio of 4:3.
16:9	Projects at an aspect ratio of 16:9.

Aspect Mode	Explanation
Full	Projects at the full size of the projected screen.
H-Zoom	Projects by enlarging the input image to the full width of the projected screen while retaining the aspect ratio. Areas that exceed the edges of the projected screen are not projected.
V-Zoom	Projects by enlarging the input image to the full height of the projected screen while retaining the aspect ratio. Areas that exceed the edges of the projected screen are not projected.
Native	Projects to the center of the projected screen at the resolution of the input image. Areas that exceed the edges of the projected screen are not projected.



- You can also set the aspect ratio from the Configuration menu.
 - ☛ **Signal - Aspect** [p.137](#)
- If parts of the computer image are missing, set the **Resolution** setting to **Wide** or **Normal** from the Configuration menu, according to the resolution of the computer.
 - ☛ **Signal - Resolution** [p.137](#)

The aspect mode changes as shown in the tables below.













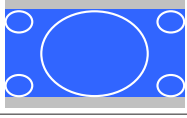



The following colors in screen images in the tables indicate areas that are not displayed.

: The area where the image is not displayed depending on the screen type setting.

: The area where the image is not displayed depending on the aspect mode setting.



EB-G7905U/EB-G7900U/EB-G7500U/EB-G7400U/EB-G7200W/EB-G7000W

Screen type setting: 16:10

	Aspect Ratio of Input Signal		
	16:10	16:9	4:3
Auto or Normal			
16:9			
Full			
H-Zoom			
V-Zoom			
Native*			

* The image may differ depending on the resolution of the input signal.

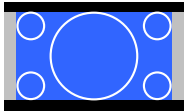
Screen type setting: 16:9

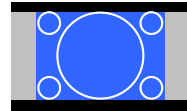
	Aspect Ratio of Input Signal		
	16:10	16:9	4:3
Auto or Normal			

	Aspect Ratio of Input Signal		
	16:10	16:9	4:3
Full			
H-Zoom			
V-Zoom			
Native*			

* The image may differ depending on the resolution of the input signal.

Screen type setting: 4:3

	Aspect Ratio of Input Signal		
	16:10	16:9	4:3
Auto or Normal			
4:3			
16:9			

	Aspect Ratio of Input Signal		
	16:10	16:9	4:3
H-Zoom			
V-Zoom			
Native*			

* Only computer images and images from the HDMI port/HDBaseT port. The image may differ depending on the resolution of the input signal.

EB-G7805/EB-G7800/EB-G7100

Screen type setting: 4:3

	Aspect Ratio of Input Signal		
	16:10	16:9	4:3
Auto or Normal			
4:3			
16:9			
H-Zoom			

	Aspect Ratio of Input Signal		
	16:10	16:9	4:3
V-Zoom			
Native*			

* Only computer images and images from the HDMI port/HDBaseT port. The image may differ depending on the resolution of the input signal.

Screen type setting: 16:9

	Aspect Ratio of Input Signal		
	16:10	16:9	4:3
Auto or Normal			
Full			
H-Zoom			
V-Zoom			
Native*			

* The image may differ depending on the resolution of the input signal.

Screen type setting: 16:10

	Aspect Ratio of Input Signal		
	16:10	16:9	4:3
Auto or Normal			
16:9			
Full			
H-Zoom			
V-Zoom			
Native*			

* The image may differ depending on the resolution of the input signal.

Adjusting the Image

Hue, Saturation, and Brightness adjustment

You can adjust the **Hue** (tint), **Saturation** (vividness), and **Brightness** of the six axes R (red), G (green), B (blue), C (cyan), M (magenta), and Y (yellow) according to your preferences.

- 1 Press the [Menu] button while projecting.

2 Select **Advanced** from **Image**, and then press the [↵] button.

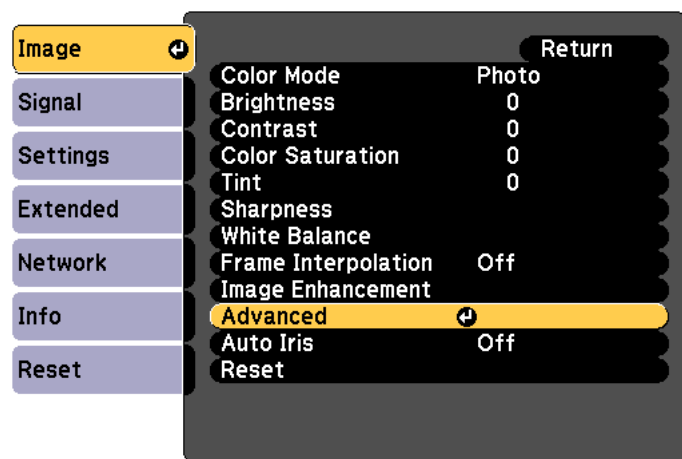

[Esc]:Return [◆]:Select [⏎]:Enter [Menu]:Exit

 You can also make adjustments from **Multi-Projection** in the Configuration menu.
 ➔ **Extended - Multi-Projection - RGBCMY** p.140

3 Select **RGBCMY**, and then press the [↵] button.

4 Use the [▲][▼] buttons to select the color you want to adjust, and then press the [↵] button.

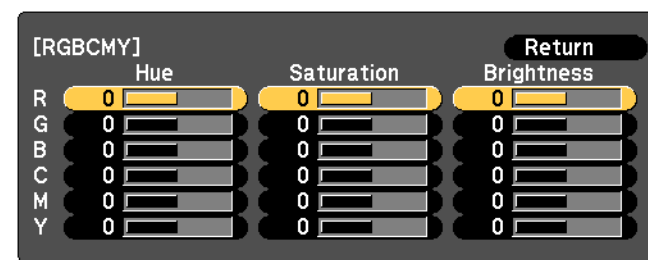

[Esc]:Return [◆]:Select [⏎]:Enter [Menu]:Exit

5 Use the [▲][▼] buttons to select the item, and then use the [◀][▶] buttons to make the adjustments.

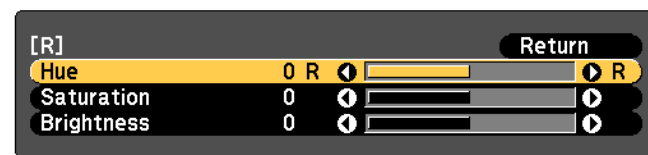

[Esc]:Return [◆]:Select [◀]:Adjust [▶]:Adjust [Menu]:Exit [Default]:Reset [⏎]:Switch Background

Each time you press the [↵] button, the adjustment screen changes.

6 To complete the corrections, press the [Menu] button.

Gamma adjustment

You can adjust differences in the halftone brightness that occurs depending on the connected device.

You can set it by using one of the following three methods.

- Select and adjust the correction value
- Adjust while viewing the image
- Adjust using the gamma adjustment graph



Adjust by projecting a still picture. Gamma cannot be adjusted correctly by using movies.

Select and adjust the correction value

- 1 Press the [Menu] button while projecting.
- 2 Select **Advanced** from **Image**, and then press the [↵] button.

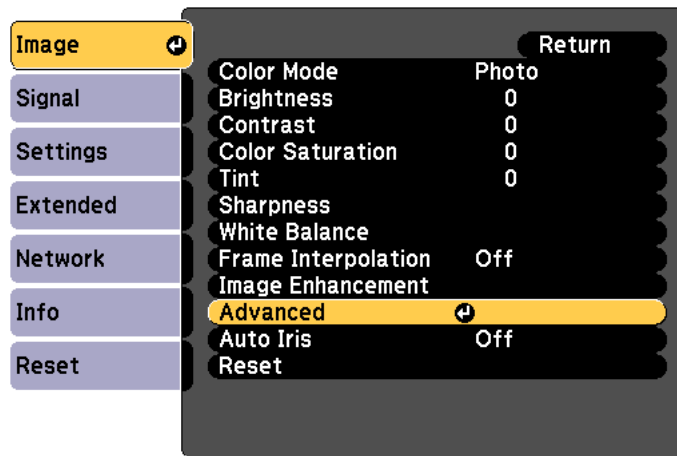

[Esc]:Return [↕]:Select [↵]:Enter [Menu]:Exit

- 3 Select **Gamma**, and then press the [↵] button.
- 4 Use the [▲][▼] buttons to select the correction value, and then use the [↵] button to confirm the selection.

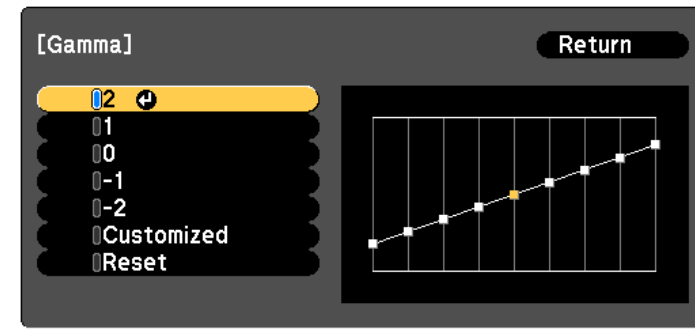

[Esc]:Return [↕]:Select [↵]:Set [Menu]:Exit

When a larger value is selected, the dark areas of images become brighter, but the color saturation for lighter areas may become weaker. When a smaller value is selected, you can reduce the overall brightness of the image to make the image sharper.

If you select **DICOM SIM** from **Color Mode** on the **Image** menu, select the adjustment value according to the projection size.

- If the projection size is 120 inches or less, select a small value.
- If the projection size is 120 inches or more, select a large value.



Medical images may not be reproduced correctly according to your installation environment and screen specifications.

Adjust while viewing the image

Select a point on the image where you want to adjust the brightness, and adjust only the selected tone.

- 1 Press the [Menu] button while projecting.
- 2 Select **Advanced** from **Image**, and then press the [↵] button.

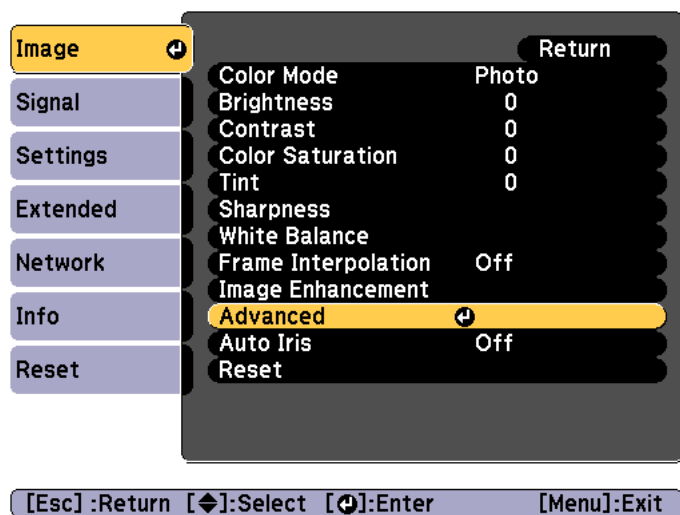

- 3** Select **Gamma**, and then press the [↵] button.
- 4** Select **Customized**, and confirm using the [↵] button.
- 5** Select **Adjust it from the image**, and confirm using the [↵] button.

- 6** Move the cursor on the projected image to the part where you want to change the brightness, and then press the [↵] button. If you press [↵], the image flashes and you can check the tone area of the adjustment target.

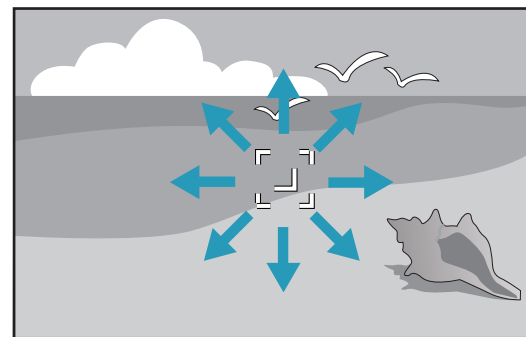

- 7** Use the [▲][▼] buttons to make adjustments, and then confirm using the [↵] button.

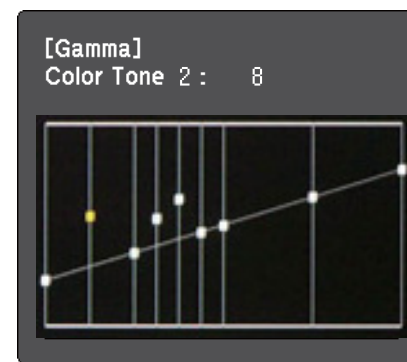

- 8** When **Do you want to continue adjusting the setting?** is displayed, select **Yes** or **No**. To adjust another location, select **Yes**, and repeat the procedure from step 6.

Adjust using the gamma adjustment graph

Select a tone point on the graph and make adjustments.

- 1 Press the [Menu] button while projecting.
- 2 Select **Advanced** from **Image**, and then press the [↵] button.

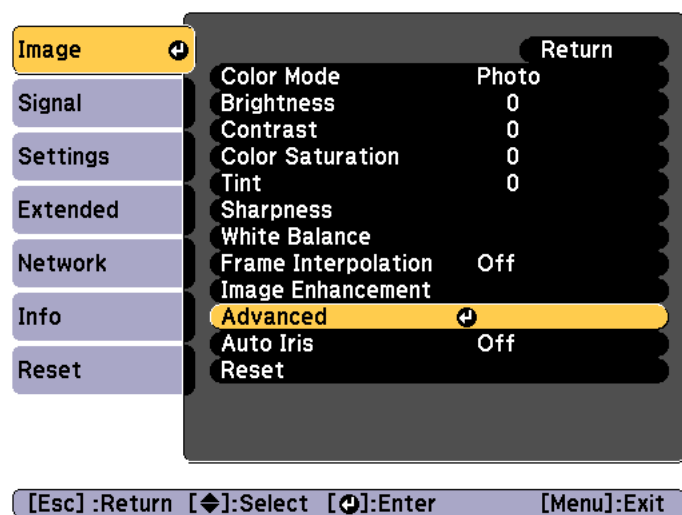

- 3 Select **Gamma**, and then press the [↵] button.
- 4 Select **Customized**, and confirm using the [↵] button.
- 5 Select **Adjust it from the graph**, and confirm using the [↵] button.

- 6 Use the [◀][▶] buttons to select the tone that you want to change, and then use the [▲][▼] buttons to make the adjustments. When you have finished making changes, confirm by using the [↵] button.

If you use the [◀][▶] buttons to select the tone that you want to change, the image flashes and you can check the tone area of the adjustment target.

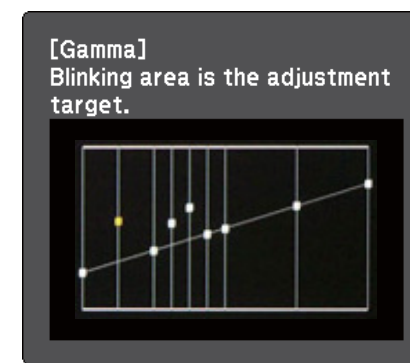

- 7 When **Do you want to continue adjusting the setting?** is displayed, select **Yes** or **No**.
To adjust another tone, select **Yes**, and repeat the procedure from step 6.

Frame Interpolation

The current and previous frames are used to create intermediate frames, interpolating to produce smooth-moving images. You can resolve clumsy-moving images, such as frame skipping when projecting a fast moving image.

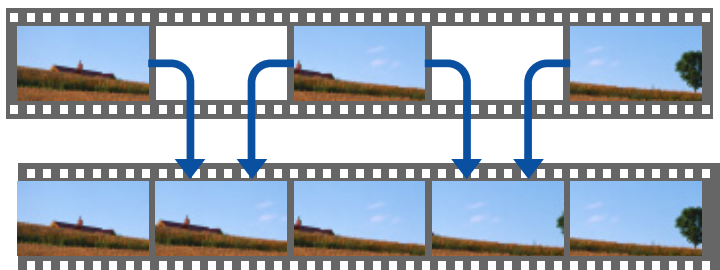

- 1 Press the [Menu] button while projecting.
- 2 Select **Frame Interpolation** from **Image**, and then press the [↵] button.

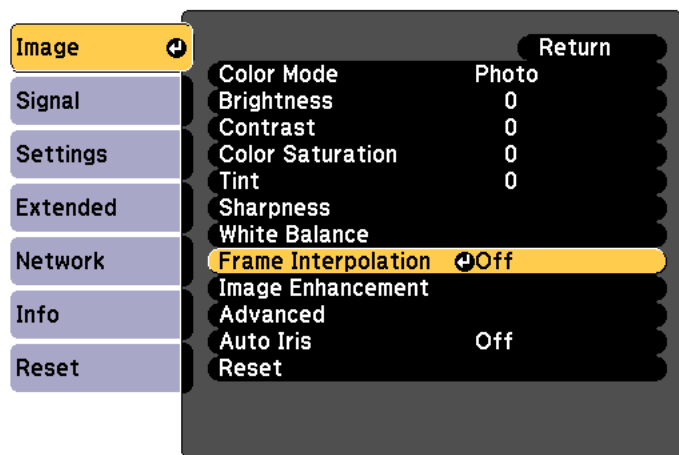

[Esc] :Return [↵]:Select [↵]:Enter [Menu]:Exit

- 3 Select the level of interpolation from **Low**, **Normal** or **High**. Set to **Off** if noise occurs after setting them.

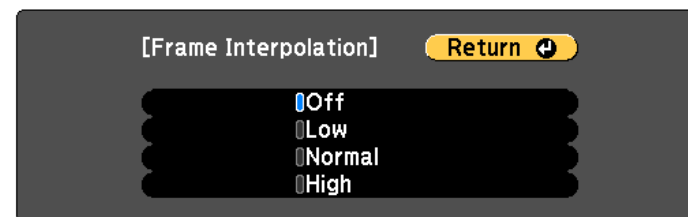

[Esc] / [↵]:Return [↵]:Select [Menu]:Exit

- 4 Press the [Menu] button to finish making settings.

Adjusting Image Resolution (Image Enhancement)

You can adjust the resolution of the image using **Image Enhancement** to reproduce a clear image with an emphatic texture and material feel.

- 1 Press the [Menu] button while projecting.

- 2 Select **Image Enhancement** from **Image**, and then press the [↵] button.

The following screen is displayed.

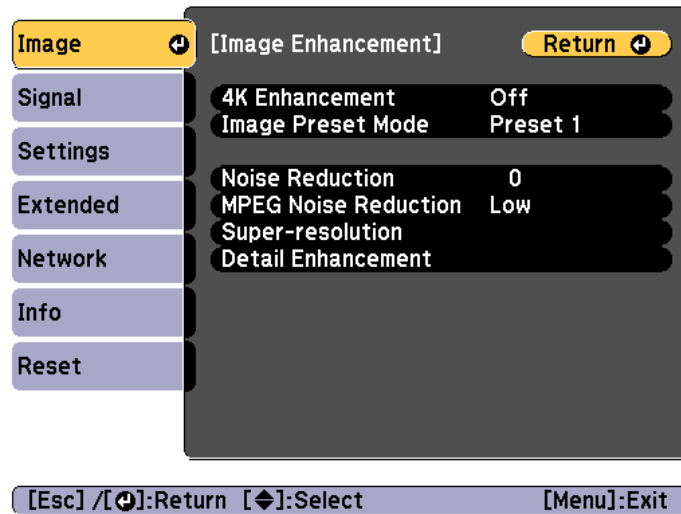

4K Enhancement (EB-G7900U/EB-G7400U only)

4K Enhancement is a function that projects an image at a doubled resolution by diagonally shifting 1 pixel in increments of 0.5 pixels.

A high-resolution image signal is projected in fine detail.

- 1 Select **4K Enhancement** from **Image Enhancement**, and then press the [↵] button.

- 2 Select one of the following, and then press the [↵] button.

Off: Disables 4K Enhancement. If a signal that exceeds the panel resolution of this projector is input, the image is displayed according to the panel resolution of this projector.

Full HD: If a signal with a resolution of 1080i/1080p/WUXGA or higher is input, 4K Enhancement is enabled.

WUXGA+: If a signal with a resolution that exceeds WUXGA is input, 4K Enhancement is enabled. To project a high-resolution movie, you can project a high-definition image by using this setting with **Image Preset Mode**.

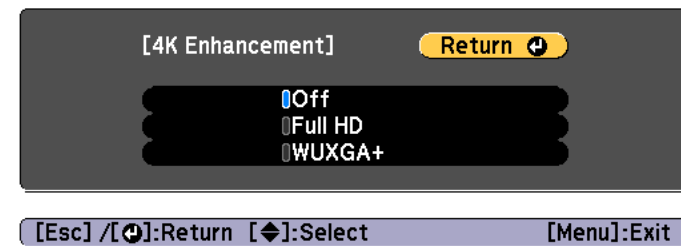

- To project from multiple projectors, select **Off** to unify each image.
- **Off** is ideal for projecting presentation materials from computers and so on.
- If set to **Full HD** or **WUXGA+**, the status corrected using the following function is canceled.
Edge Blending, Scale, Curved Surface, Point Correction, Corner Wall
When **4K Enhancement** is set to **Off**, the settings returns to the previous state.
- If **4K Enhancement** is enabled and the surrounding temperature gets high, the lamp may automatically dim.

- 3 Press the [Esc] button to return to the previous screen.

Image Preset Mode

Select the optimal setting according to the projected image from five presets prepared in advance.

The following settings are saved in the presets.

Noise Reduction, MPEG Noise Reduction, Super-resolution, Detail Enhancement

1 Select **Image Preset Mode** from **Image Enhancement**, and then press the [↵] button.

2 Select one of the following, and then press the [↵] button.

Preset 1 to Preset 5: The settings saved in advance are applied to the image.

Off: Select this to turn off presets.

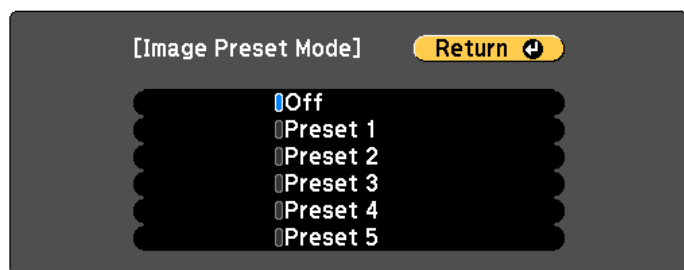

[Esc] / [⏪]:Return [⏩]:Select [Menu]:Exit



- After selecting **Preset 1 to Preset 5**, you can fine tune each setting individually. The setting after adjustment will be overwritten.
- The setting after adjustment will be overwritten separately when **4K Enhancement** is enabled and disabled.

3 Press the [Esc] button to return to the previous screen.

Noise Reduction

You can smooth out rough images for softer image quality when inputting progressive signals or progressive interlace signals.



This is disabled in the following cases.

- When **Image Processing** is set to **Fast 2**
- When **4K Enhancement** is enabled
- When a signal with a resolution that exceeds WUXGA is input

1 Select **Noise Reduction** from **Image Enhancement**, and then press the [↵] button.

2 Use the [◀][▶] buttons to adjust the value.

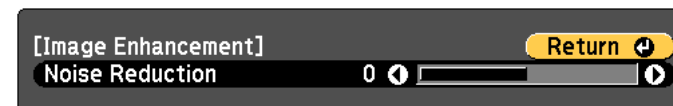

[Esc] / [⏪]:Return [⏩]:Select [Menu]:Exit

3 Press the [Esc] button to return to the previous screen.

MPEG Noise Reduction

You can reduce dot and block noise that occurs in outlines when projecting MPEG movies.



This is disabled in the following cases.

- When **4K Enhancement** is enabled
- When a signal with a resolution that exceeds WUXGA is input

1 Select **MPEG Noise Reduction** from **Image Enhancement**, and then press the [↵] button.

2 Select a level to reduce noise from **Low**, **Normal**, or **High**, and then press the [↵] button.

If **Off** is selected, **MPEG Noise Reduction** is disabled.

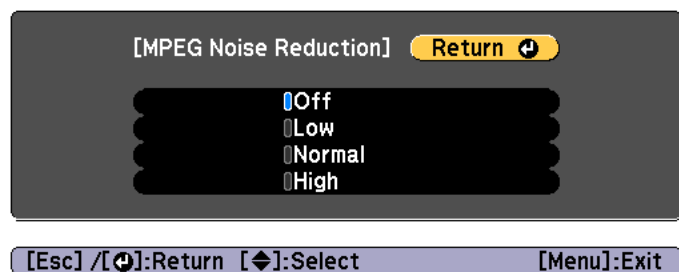

3 Press the [Esc] button to return to the previous screen.

Super-resolution

To display a crisp image, you can reduce the blurring that is created on the edge when the resolution of the image signal is scaled up and projected.

1 Select **Super-resolution** from **Image Enhancement**, and then press the [↵] button.

2 Use the [▲][▼] buttons to select the item, and then use the [◀][▶] buttons to make the adjustments.

Fine Line Adjust: If this parameter is set to a positive value, details such as hair or fabric patterns will be enhanced.

Soft Focus Detail: If this parameter is set to a positive value, the outline, background, and the other main parts of the objects in the image will be enhanced to show them clearly.

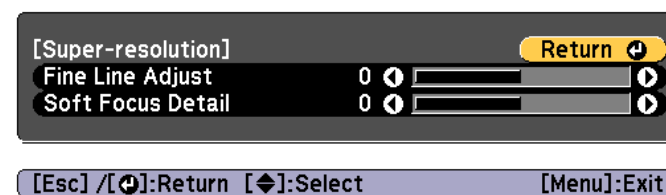

3 Press the [Esc] button to return to the previous screen.

Detail Enhancement

You can enhance the contrast in detailed areas of an image to create a more emphatic texture and material feel.

1 Select **Detail Enhancement** from **Image Enhancement**, and then press the [↵] button.

- 2** Use the [▲][▼] buttons to select the item, and then use the [◀][▶] buttons to make the adjustments.

Strength: The larger the value, the more the contrast is enhanced.

Range: The larger the value, the wider the range of detail enhancement becomes.

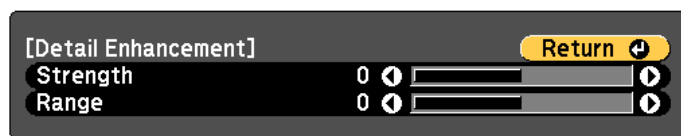

[Esc] / [◀]:Return [▶]:Select [Menu]:Exit



Depending on the image, a highlight may be noticeable at the border between colors. If this bothers you, set a smaller value.

- 3** Press the [Esc] button to return to the previous screen.

Projecting 3D images

By using two projectors, you can project passive 3D images. The following are required to project and view 3D images.

- Polarizer
- Passive 3D glasses
- Mount for stacking
- Silver screen for passive 3D



This projector arranges the direction of polarizing projection for R (red), G (green), and B (blue). It is not necessary to inverse left and right eye G (green) image signals.



Useful Functions

This section describes the Multi-Projection, Split Screen, Memory, Schedule, and Security functions.

When projecting to a wide screen from multiple projectors, you can adjust the difference of brightness and color tone between each projected image to create a seamless screen.



- Set **4K Enhancement** to **Off**. (EB-G7900U/EB-G7400U only)
- We recommend setting the focus, zoom, and lens shift at least 20 minutes after you start the projection, because images are not stable right after turning on the projector.
- If the values for **Geometric Correction** are large, the image position adjustment for overlapping images becomes difficult.
- The Test Pattern can be displayed to adjust the projection status without connecting video equipment.
 - ☛ "Displaying a Test Pattern" [p.32](#)
- If you project a dot by dot image that can be projected without being enlarged or reduced, you can make adjustments precisely.

Preparation

Follow the steps below to adjust the projected images for the multi-projection function.

- 1** Set an ID for the projector and the remote control.
 - ☛ "Set the projector ID" [p.41](#)
- 2** Adjust the position of the projected image in the following order (starting from the adjustments that have larger corrections).
 - (1) Projector's position (angle)
 - ☛ "Installation Settings" [p.28](#)
 - (2) Lens shift/Zoom
 - ☛ "Adjusting the Position of the Projected Image (Lens Shift)" [p.33](#)
 - ☛ "Adjusting the Image Size" [p.36](#)
 - (3) Correct the four image corners
 - ☛ "Quick Corner" [p.64](#)

- (4) Correct the slight position misalignment that occurs when matching the projected images
 - ☛ "Point Correction" [p.84](#)

- 3** Set the **Color Mode** to **Multi-Projection** with the [Color Mode] button.

When set to another color mode (except for sRGB), the border between multiple images may be noticeable even with correction using Edge Blending.

- 4** Adjusts the color tone for the whole screen as necessary.
 - ☛ "Color Uniformity" [p.198](#)

Edge Blending

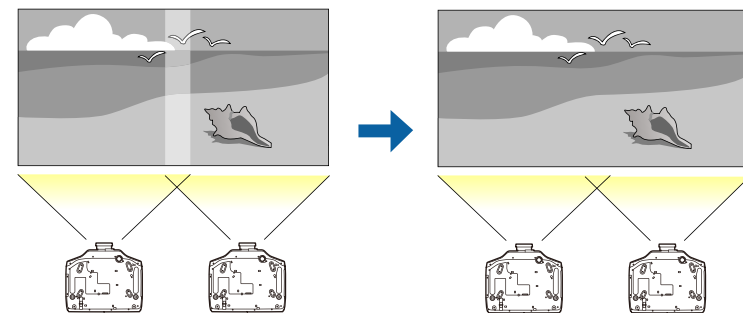

Follow the steps below to adjust so that the overlapping areas of the images are less noticeable.

- (1) Fine tune the overlapping areas to make seamless screen.
 - ☛ "Adjust the Edges of the Images (Edge Blending)" [p.102](#)
- (2) Adjust the brightness difference for each projector lamp.
 - ☛ "Correcting the Brightness (EB-G7900U/EB-G7200W/EB-G7000W/EB-G7800 only)" [p.104](#)

- (3) Adjust the color balance of the projected images.
 ☛ "Fine-tuning the color balance" p.105

Adjust the Edges of the Images (Edge Blending)

You can fine tune the overlapping areas to make seamless screen.

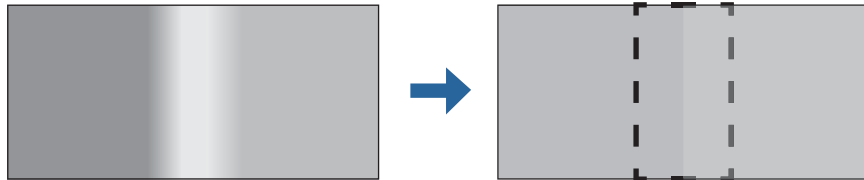

- 1 Press the [Menu] button while projecting.
 ☛ "Using the Configuration Menu" p.132
- 2 Select **Multi-Projection** from **Extended**.

- 3 Select **Edge Blending**, and then press the [↵] button.
 The following screen is displayed.

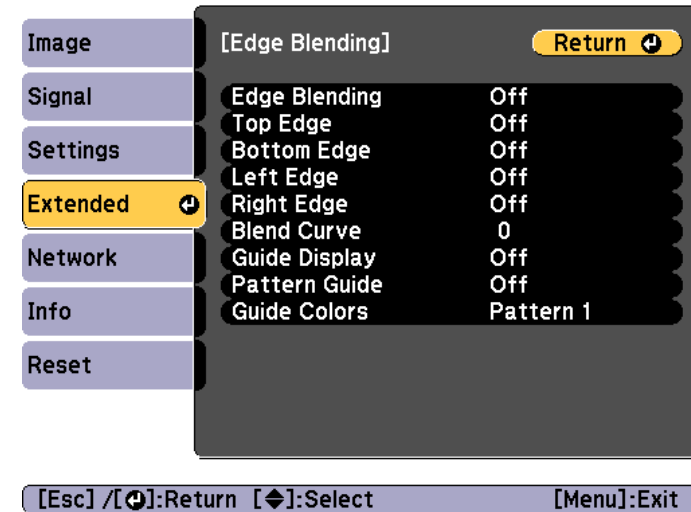

Submenu	Function
Edge Blending	Set to On to activate Edge Blending. Set to Off when not projecting from multiple projectors.
Top Edge/Bottom Edge/Left Edge/Right Edge	<p>Blending: Set to On to activate Edge Blending towards your settings, and the blend range will be shaded.</p> <p>Blend Start Position: Displays blending start position as a red line, and adjusts at the level of one pixel.</p> <p>Blend Range: Adjusts the range to be shaded. Adjustment is possible at the level of one pixel. The maximum range is 45% of the resolution.</p>
Blend Curve	You can select from three ways of shading.
Guide Display	Set to On to display a guide on the Edge Blending setting range.

Submenu	Function
Pattern Guide	Set to On to display a guide to match the position of the Edge Blending setting range.
Guide Colors	Select a combination of guide colors from the three provided.

4 Turn on Edge Blending.

- (1) Select **Edge Blending**, and then press the [**↵**] button.
- (2) Select **On**, and then press the [**↵**] button.
- (3) Press the [Esc] button.

5 Set **Guide Display** to **On**.

- (1) Select **Guide Display**, and then press the [**↵**] button.
- (2) Select **On**, and then press the [**↵**] button.
- (3) Press the [Esc] button.



If the guide is not clear, you can change the color of the guide on **Guide Colors**.

6 Set **Pattern Guide** to **On**.

- (1) Select **Pattern Guide**, and then press the [**↵**] button.
- (2) Select **On**, and then press the [**↵**] button.
- (3) Press the [Esc] button.

7 Set **Top Edge**, **Bottom Edge**, **Left Edge**, or **Right Edge** according to the parts of the image that are overlapped.

The following shows how to set screen (1) as an example.

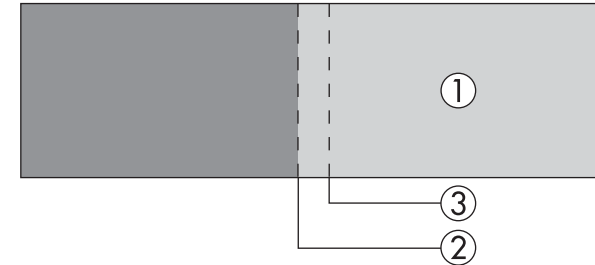

In the example above, you need to adjust the **Left Edge** because you can see the overlapping areas on the left side of the image (1).

- (1) Select **Left Edge**, and then press the [**↵**] button.
- (2) Select **Blending**, and then press the [**↵**] button.
- (3) Select **On**, and then press the [**↵**] button.
- (4) Press the [Esc] button.
- (5) In **Blend Start Position**, align the blending start position with the edge (2) of the image.
- (6) Press the [Esc] button.
- (7) In **Blend Range**, adjust the range (3) to be shaded.

The value for when the overlapped range and the guide are in the same position is the best.

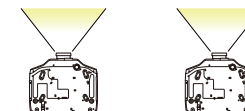
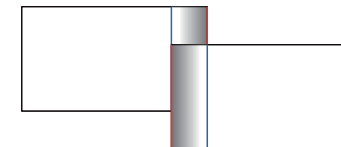

- (8) Press the [Esc] button.

- 8** Set **Blend Curve**.
- (1) Select **Blend Curve**, and then press the [**↵**] button.
 - (2) Select the amount of shading from **1** to **3**, and then press the [**↵**] button.
 - (3) Press the [Esc] button.
- 9** After the settings are complete, set **Guide Display** and **Pattern Guide** to **Off** to finish.

Correcting the Brightness (EB-G7900U/EB-G7200W/EB-G7000W/EB-G7800 only)

You can adjust the **Brightness Level** so that the lamp brightness is the same for each projector.

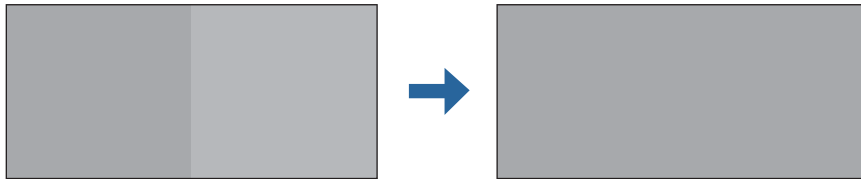

Adjust so that all projectors are the same brightness as the darkest lamp.



- Set **Power Consumption** to **Normal**.
 ⚙️ **Settings - Power Consumption** [p.138](#)
- Even if you adjust the **Brightness Level**, the brightness of each lamp may not match exactly.

- 1** Select **Brightness Level** from **Multi-Projection**, and then press the [**↵**] button.

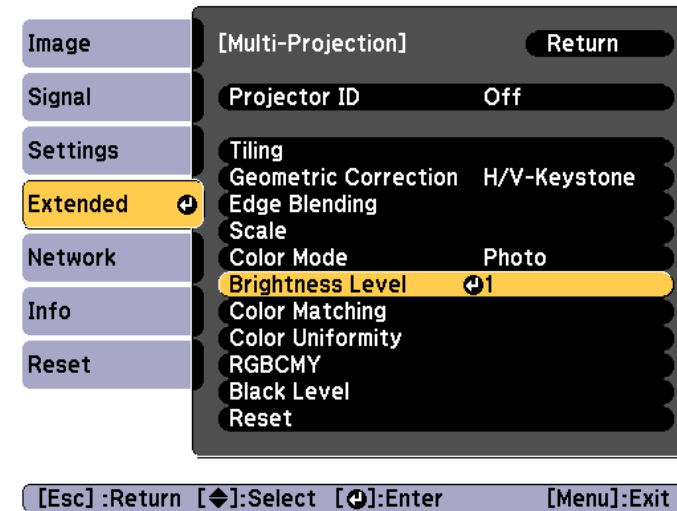

- 2** Select a brightness level.
 The brightness level varies depending on the model being used and the projection method.

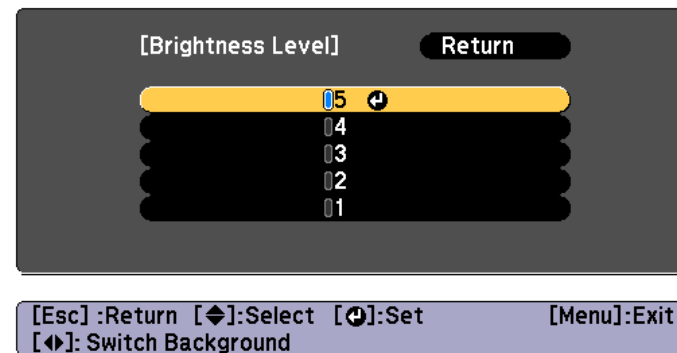



- When **Portrait Mode** is **On**, brightness is adjusted in three levels.
- When **Portrait Mode** is **Off**, brightness is adjusted in three or five levels, depending on the model being used.
- You can switch the projected image between the input image and the white image using the [◀][▶] buttons.

3 Press the [Esc] button to return to the previous screen.

Fine-tuning the color balance

Adjust the brightness of the projected image and the color balance that was adjusted by Edge Blending.



The brightness and color may not be uniform even after making adjustments.

Color Matching

You can fine tune the color balance and brightness from black to white for each color tone.

1 Select **Color Matching** from **Multi-Projection**, and then press the [↵] button.

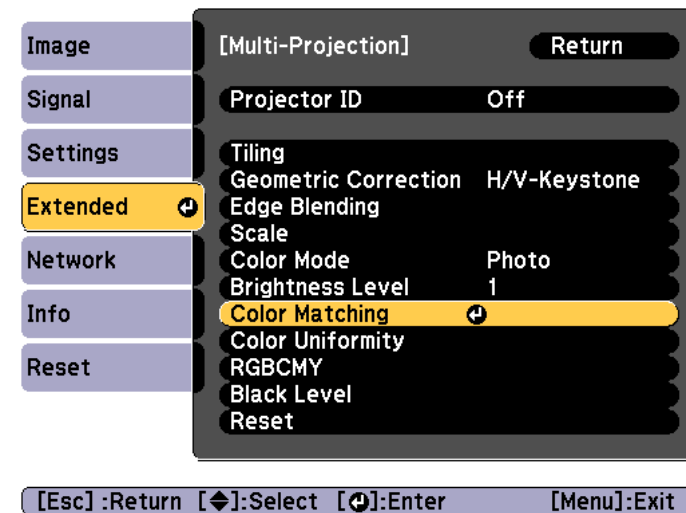

The following screen is displayed.

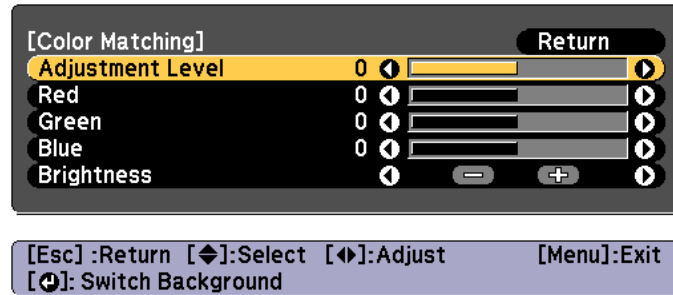

Half of the overlapped area is displayed in black so that it is easy to check the edge of the image.

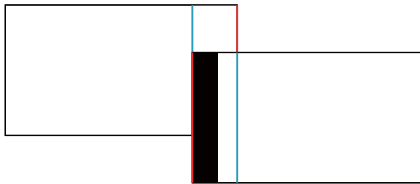

Adjustment Level: There are eight levels from white, through gray, and up to black. Adjust each level individually.

Red, Green, Blue: Adjusts the tone for each color.

Brightness: Adjusts the image brightness.



Whenever the [Left Arrow] button is pressed, the screen changes between the projected image and the adjustment screen.

- 2** Select **Adjustment Level**, and then use the [Left Arrow][Right Arrow] buttons to set the adjustment level.
- 3** Select **Red**, **Green**, or **Blue**, and then press the [Left Arrow][Right Arrow] buttons to adjust the color tone.

- 4** Select **Brightness**, and then use the [Left Arrow][Right Arrow] buttons to adjust the brightness.
- 5** Return to step 2 and adjust each level.
- 6** Press the [Esc] button to return to the previous screen.

Adjusting RGBCMY

The Hue, Saturation, and Brightness for each of the R (red), G (green), B (blue), C (cyan), M (magenta) and Y (yellow) color components can be adjusted.

After adjustment using Color Matching, adjust if you are concerned about differences of the colors.

☞ "Hue, Saturation, and Brightness adjustment" [p.90](#)

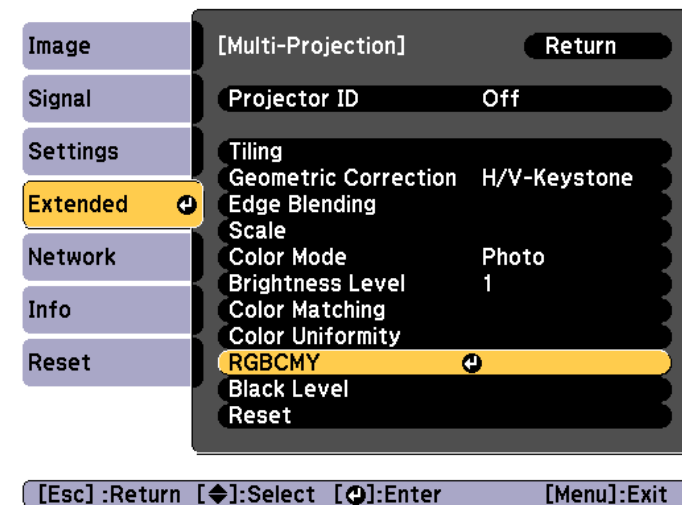

Black Level

When a black image is displayed, only areas where the images overlap stand out. The black level function allows you to match the brightness and tone for areas where the images do not overlap with areas where the images overlap, to make the difference less noticeable.

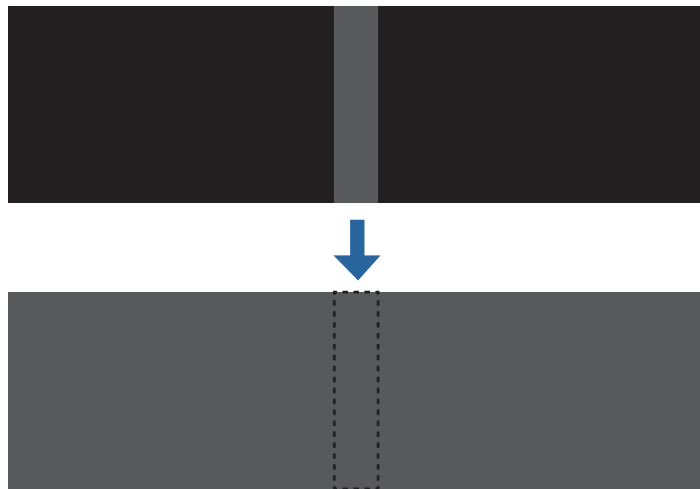

- You cannot adjust the Black Level when a test pattern is displayed.
- If the **Geometric Correction** value is large, you may not be able to adjust correctly.
- The brightness and tone may differ in areas where the images overlap as well as in other areas even after performing black level adjustment.
- If you change the **Top Edge/Bottom Edge/Right Edge/Left Edge** setting, the Black Level is returned to its default value.
 🖱️ "Adjust the Edges of the Images (Edge Blending)" [p.102](#)

- 1 Select **Black Level** from **Multi-Projection**, and then press the [↵] button.

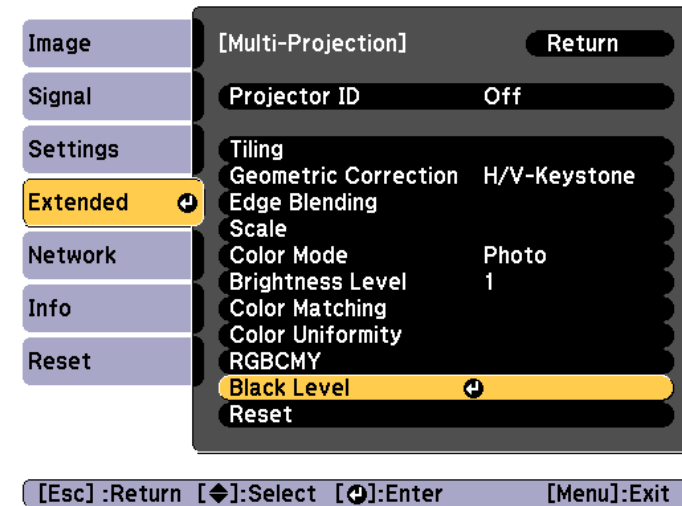

- 2 Select **Color Adjustment**, and then press the [↵] button.

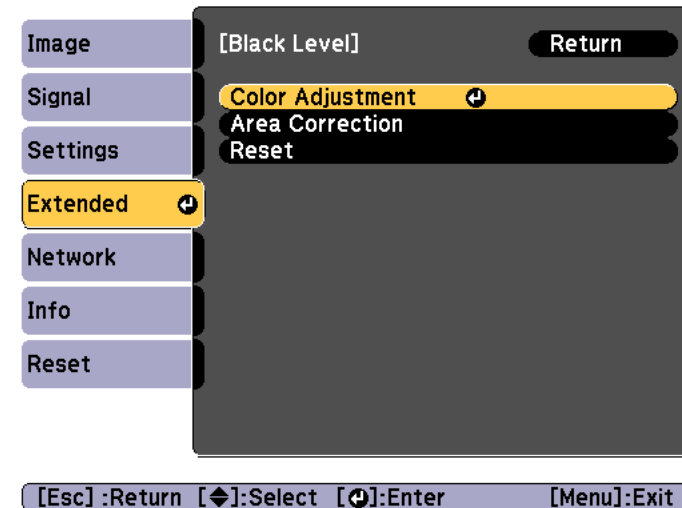

The areas are displayed based on the settings for **Top Edge/Bottom Edge/Right Edge/Left Edge**.

- 3 Select the area you want to adjust, and then press the [↵] button.

The selected area is displayed in orange.



When multiple screens are overlapping, adjust based on the area with the most overlap (the brightest area). In the illustration below, first align (2) with (1), and then adjust so that (3) aligns with (2).

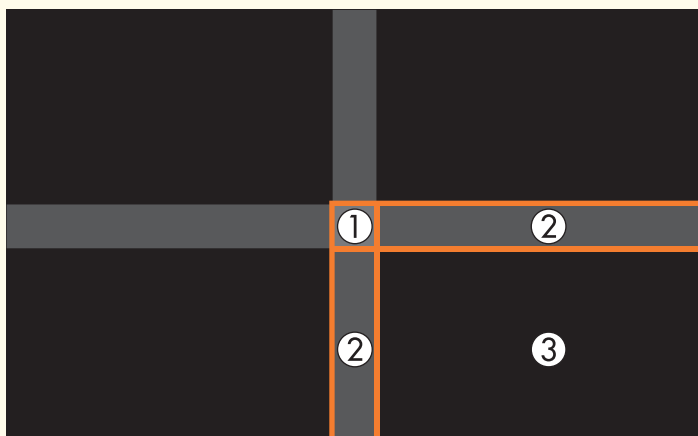

- 4 Adjust the black tone and brightness.

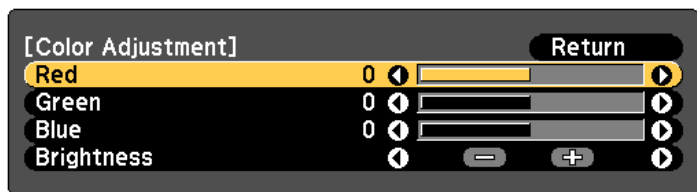

[Esc] :Return [↩]:Select [↶]:Adjust [Menu]:Exit
[Default] :Reset

- 5 Repeat steps 3 and 4 as needed to adjust any remaining parts.



After this, if the tone for some areas do not match, adjust them by **Area Correction**.

- 6 Press the [Esc] button, to return to the screen displayed in step 2.

- 7 Select **Area Correction**, and then press the [↵] button.

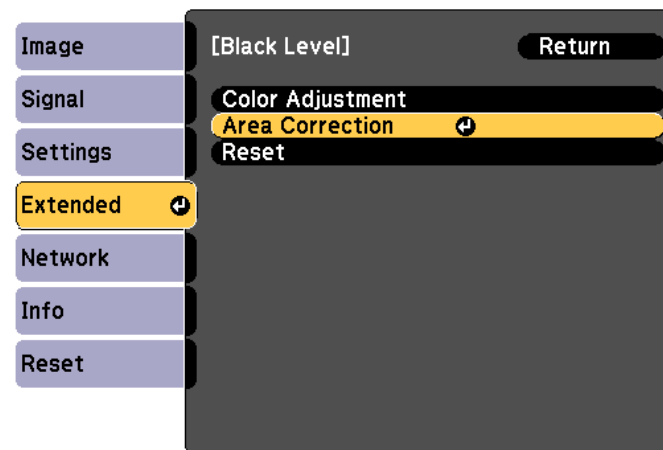

[Esc] :Return [↩]:Select [↵]:Enter [Menu]:Exit

- 8 Select **Start Adjustments**, and then press the [↵] button.

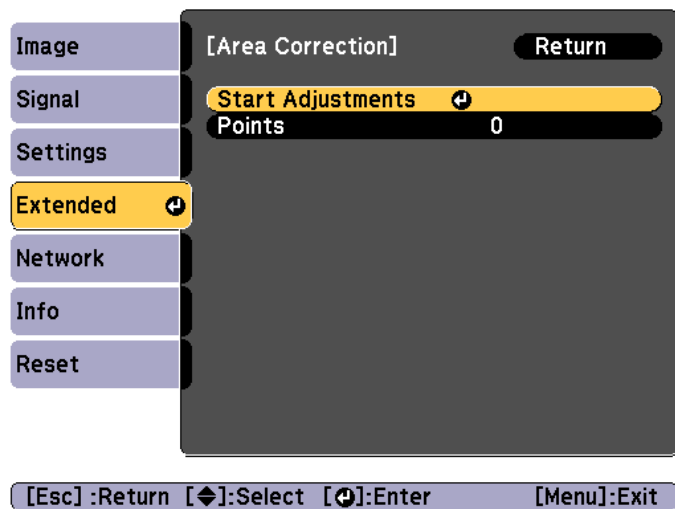

Boundary lines that indicate areas where images overlap are displayed.

The boundary lines are displayed based on the settings for **Top Edge/Bottom Edge/Right Edge/Left Edge**.

- 9** Use the [▲][▼][◀][▶] buttons to select a boundary line of the area you want to adjust.

The selected line is displayed in orange.



- 10** Press the [↵] button to confirm the selection.

The points where you want to set the range for adjustment are displayed.

You can change the number of points displayed on one side in **Points** on the screen from step 8.

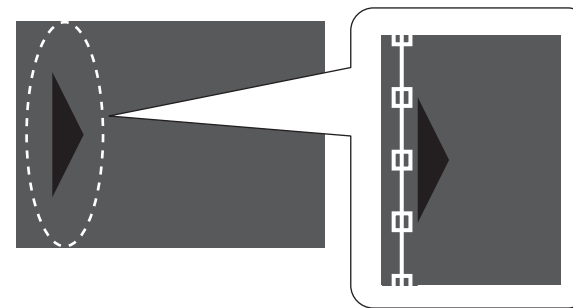

- 11** Use the [▲][▼][◀][▶] buttons to adjust the boundary line positions, and then press the [↵] button.

- 12** Press the [▲][▼][◀][▶] buttons to select the point you want to move, and then press the [↵] button.

The selected point is displayed in orange.

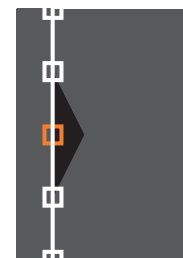

- 13** Press the [▲][▼][◀][▶] buttons to move the point.

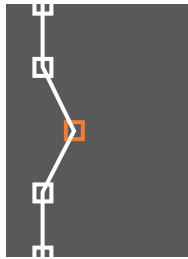

To continue to move another point, press the [Esc] button to return to step 12, and then repeat steps 12 and 13.

To adjust another boundary line, press the [Esc] button until the screen for selecting a boundary line from step 9 is displayed.



To return **Black Level** to its default value, press the [Esc] button to return to the screen from step 7, select [Reset], and then press the [↵] button.

14 To complete the adjustment, press the [Menu] button.

Tiling

Project the same image from multiple projectors to create one large image. You can project by using up to nine projectors.

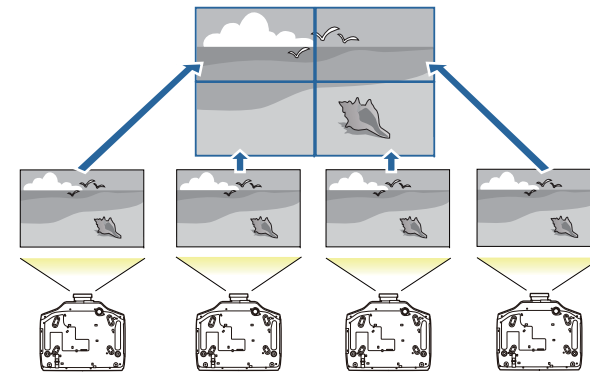

Before performing tiling, adjust the projected image so that it is a rectangle.

- 1** Set an ID for each projector to be used for tiling, and then adjust the positions of the projected images.
 - ☛ "Preparation" p.101
- 2** Adjust the overlapping areas of the screens using edge blending.
 - ☛ "Edge Blending" p.101
- 3** Press the [Menu] button while projecting.
- 4** Select **Multi-Projection** from **Extended**, and then press the [↵] button.
- 5** Select **Tiling**, and then press the [↵] button.
- 6** Select **Layout**, and then press the [↵] button.
 - (1) Set the number of projectors in **Row** and **Column**.
 - (2) Select **Set**, and then press the [↵] button.

- 7** Repeat steps 2 to 6 for each projector to be used for tiling.
- 8** Select **Location Setup**, and then press the [**↵**] button.
- (1) Set the positions of the projected images in **Row Order** and **Column Order**.
- Row Order:** Place screens from top to bottom in the order of 1, 2, 3.
Column Order: Place screens from left to right in the order of A, B, C.

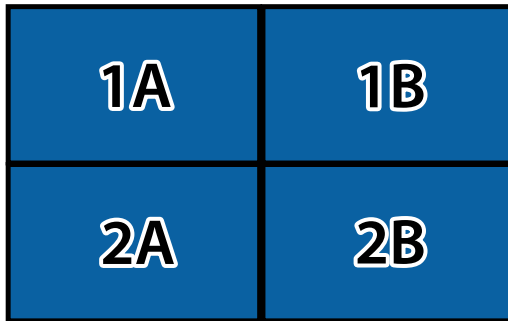

- (2) Select **Set**, and then press the [**↵**] button.
- 9** Repeat step 8 for each projector.
- 10** Input the image signal to display the image.
- ☛ "Automatically Detecting Input Signals and Changing the Projected Image (Source Search)" [p.59](#)
- 11** Set **Scale** to **Auto**.
- (1) Select **Multi-Projection** from **Extended**.
- (2) Select **Scale**, and then press the [**↵**] button.
- (3) Select **Auto** from **Scale**, and then press the [**↵**] button.

The scale and clip range are automatically set according to the blending width.

- 12** Fine tune the overlapping areas of the screens.
- ☛ "Correcting Distortion in the Projected Image" [p.62](#)
 - ☛ "Adjust the Edges of the Images (Edge Blending)" [p.102](#)

Displaying a Scaled Image

A section of the image is cropped and displayed. This allows you to create one large image by combining images projected from multiple projectors.

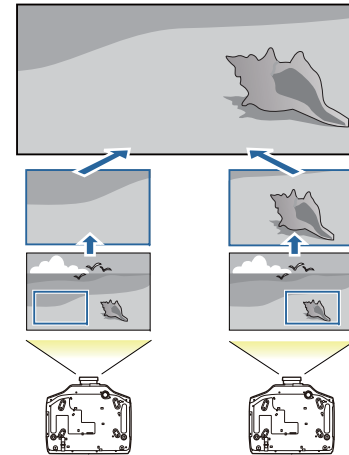

- 1** Project the image, and then press the [Menu] button.
- ☛ "Using the Configuration Menu" [p.132](#)

- 2** Select **Multi-Projection** from **Extended**.



You can also perform the same operation from **Scale** in **Signal**.

- 3** Select **Scale**, and then press the [**↵**] button.

- 4 Turn on Scale.**
- (1) Select **Scale**, and then press the [**↵**] button.
 - (2) Select **Manual**, and then press the [**↵**] button.
 - (3) Press the [Esc] button to return to the previous screen.

- 5 Set Scale Mode.**
- (1) Select **Scale Mode**, and then press the [**↵**] button.

- (2) Select **Zoom Display** or **Full Display**, and then press the [**↵**] button.
Zoom Display: Adjusts according to the image currently displayed.

Enlarge



Move



Full Display: Adjusts according to the projector's panel size (the maximum area in which an image can be displayed).

Enlarge



Move



- (3) Press the [Esc] button to return to the previous screen.

6 Adjust the scale.

Select the adjustment method with the [▲][▼] buttons, then adjust using the [◀][▶] buttons.

- +: Enlarges or reduces an image horizontally and vertically at the same time.

Scale Vertically: Enlarges or reduces an image vertically.

Scale Horizontally: Enlarges or reduces an image horizontally.

7 Adjust the range of the image to be cropped.

- (1) Select **Clip Adjustment**, and then press the [↵] button.
If you select **Clip Range**, the range and coordinates of the image that the projector will project is displayed.
- (2) Use the [▲], [▼], [◀], and [▶] buttons to scroll the image.
Adjust the coordinates and size of each image while viewing the screen.
- (3) Press the [Menu] button to finish making settings.

Projecting Two Images Simultaneously (Split Screen)

You can simultaneously project images from two sources on the right and left of the screen.

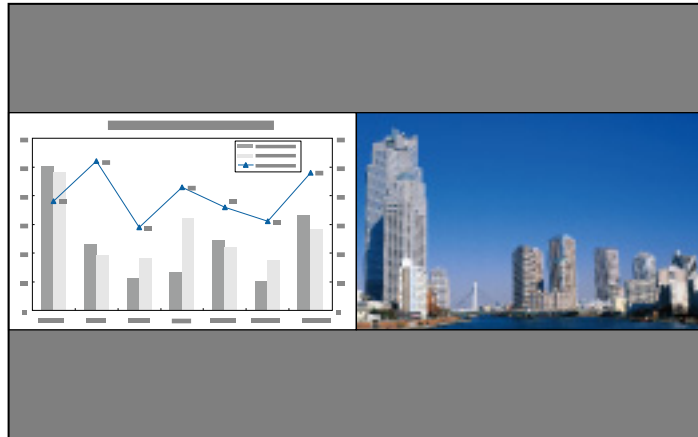

Input Sources for Split Screen Projection

The combinations of input sources that can be projected on a split screen are listed below.

Left Screen	Right Screen					
	HDMI	HDBa-seT	DVI-D	Com-puter	BNC	LAN
HDMI	-	✓	✓	✓	✓	✓
HDBaseT	✓	-	✓	✓	✓	✓
DVI-D	✓	✓	-	✓	✓	✓
Computer	✓	✓	✓	-	-	-
BNC	✓	✓	✓	-	-	-
LAN	✓	✓	✓	-	-	-



- Signals that exceed WUXGA are not supported.
- If **4K Enhancement** is enabled, a message is displayed. Select **Yes** to disable **4K Enhancement**. (EB-G7900U/EB-G7400U only)

Operating procedures

Projecting on a split screen

- 1 Press the [Split] button on the remote control while projecting. The currently selected input source is projected on the left of the screen.

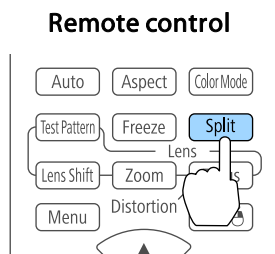

You can perform the same operations from the configuration menu.

☛ [Settings - Split Screen p.138](#)

- 2 Press the [Menu] button. The Split Screen Setup screen is displayed.

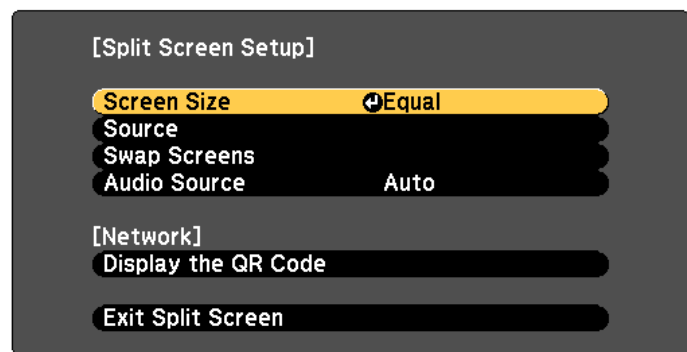

[↔]:Select [↵]:Enter

[Menu]:Exit

- 3 Select **Source**, and then press the [↵] button.
- 4 Select each input source for **Left** and **Right**.

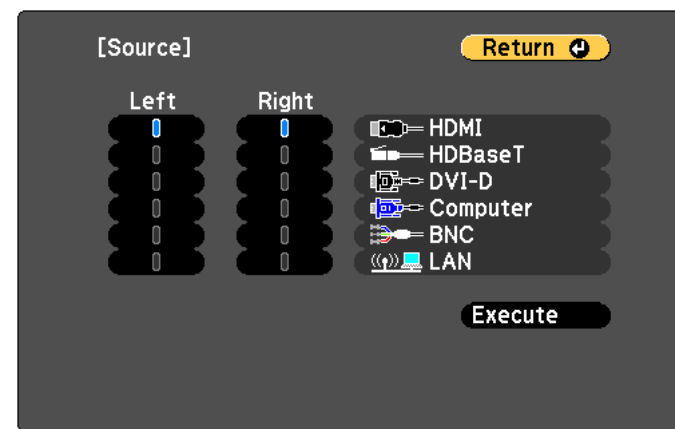

[Esc] / [↵]:Return [↔]:Select

[Menu]:Exit



You can perform the same operations using the following procedure.

- ☛ "Automatically Detecting Input Signals and Changing the Projected Image (Source Search)" [p.59](#)
- ☛ "Switching to the Target Image by Remote Control" [p.60](#)

- 5 Select **Execute**, and then press the [↵] button.

To switch the source during split screen projection, start the procedure from step 2.

Switching the left and right screens

Use the following procedure to switch the projected images displayed on the left and right screens.

- 1 Press the [Menu] button during split screen projection.
- 2 Select **Swap Screens**, and then press the [↵] button.
The projected images on the left and right are swapped.



Switching the left and right image sizes

- 1 Press the [Menu] button during split screen projection.
- 2 Select **Screen Size**, and then press the [↵] button.
- 3 Select the screen size you want to display, and then press the [↵] button.

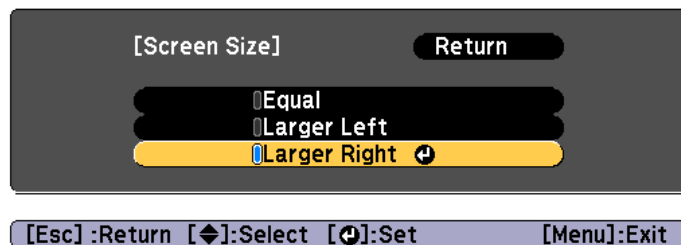

The projected images will appear as shown below after setting the screen size.

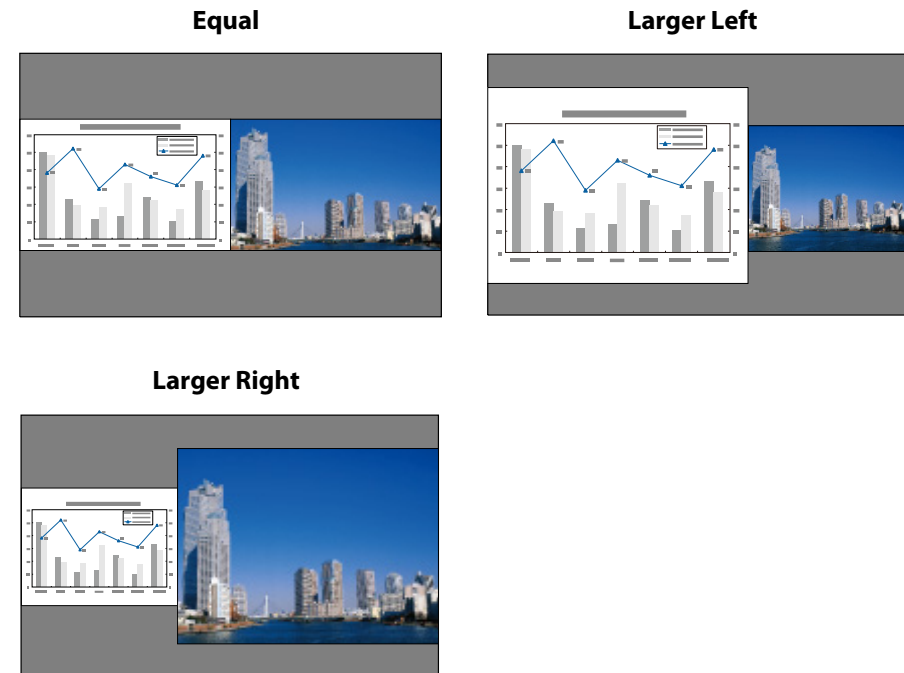

- You cannot enlarge both the left screen and right screen images at the same time.
- When one image is enlarged, the other image is reduced.
- Depending on the video signals that are input, the images on the left and right may not appear to be the same size even if **Equal** is set.

Changing the audio

- 1 Press the [Menu] button during split screen projection.
- 2 Select **Audio Source**, and then press the [↵] button.

- 3** Select the audio you want to output, and then press the [↵] button.

When you select **Auto**, audio is output for the enlarged screen. If the screen sizes are **Equal**, audio is output for the screen on the left.

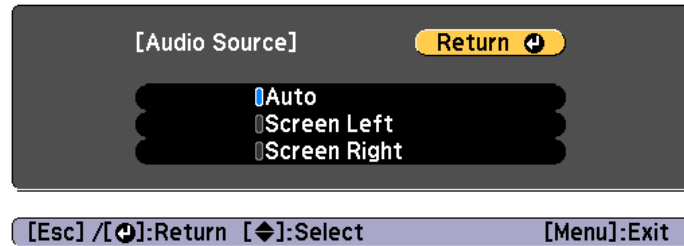

Ending the split screen

Press the [Esc] button to end split screen.

The following steps can also be used to end the split screen.

- Press the [Split] button on the remote control.
- Select **Exit Split Screen** on the Split Screen Setup screen.  [p.115](#)

Restrictions during split screen projection

Operating restrictions

The following operations cannot be performed during split screen projection.

- Setting the configuration menu
- E-Zoom
- Changing the aspect mode
- Using the [User1], [User2], or [User3] button on the remote control
- Help can be displayed only when image signals are not input or when an error or warning notification is displayed.
- The user's logo is not displayed.

Restriction relating to images

- For the image on the right screen, the default values for the **Image** menu are applied. However, the setting values for the image projected on the left screen are applied for **Color Mode**, **Color Temp.**, and **Color Adjustment**. Also, for **Super-resolution** in the **Signal** menu, the setting values for the image projected on the left screen are applied.
- **Auto Iris** and **Frame Interpolation** are not available.

Hiding the Image and Sound Temporarily (A/V Mute)

You can use this when you want to focus the audience's attention on what you are saying, or if you do not want to show details such as when you are changing between files during presentations from a computer.

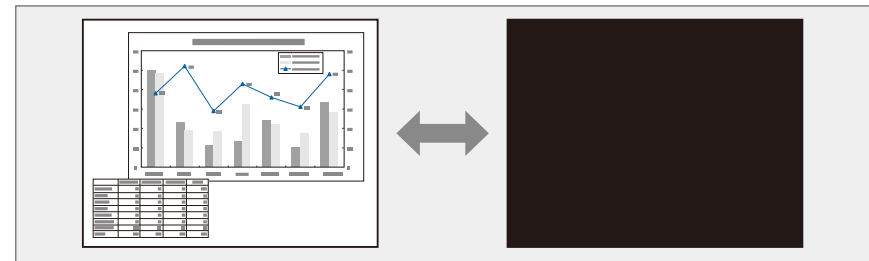

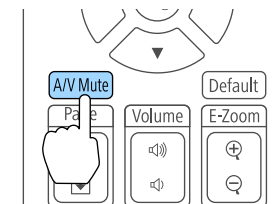

Each time you press the [A/V Mute] button, A/V Mute turns on or off.

Remote control





- If A/V mute is enabled, the electric shutter closes and projection is blocked.
- If you want to fade out or fade in when turning the video on or off, set the desired number of seconds in **Fade-out** and **Fade-in**.
 **Extended - Operation - A/V Mute Settings - Fade-out, Fade-in p.140**
- When A/V mute is activated and no operations are performed for about 2 hours, the projector turns off automatically. If you do not want to turn off the power, set **A/V Mute Timer** to **Off**.
 **Extended - Operation - A/V Mute Settings - A/V Mute Timer p.140**
- When **A/V Mute Release** is set to **A/V Mute** from the configuration menu, the following operations can still be performed without releasing A/V mute.
 - Change the source with the change input buttons on the remote control.
 - Control the projector from a computer using communication commands. **Extended - Operation - A/V Mute Settings - A/V Mute Release p.140**
 A/V mute is only released by pressing the [A/V Mute] button, or by sending an A/V mute Off command.
- When projecting moving images, the images and sound continue to be played back while A/V Mute is on. It is not possible to resume projection from the point where A/V Mute was activated.
- The lamp is still lit during A/V Mute, so the lamp hours continue to accumulate.

between files during presentations from a computer without projecting any images if the Freeze function is activated beforehand.

Each time you press the [Freeze] button, Freeze turns on or off.

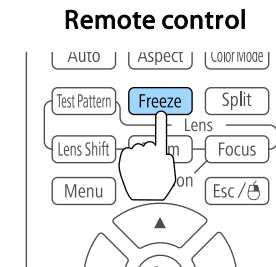

- Audio does not stop.
- When projecting moving images, the images continue to be played back while the screen is frozen. It is not possible to resume projection from the point where the screen was frozen.
- If the [Freeze] button is pressed while the Configuration menu or the Help screen is displayed, the menu or the Help screen that is displayed is closed.
- Freeze still works while E-Zoom is being used.

Freezing the Image (Freeze)

When Freeze is activated on moving images, the frozen image continues to project on the screen, so you can project a moving image one frame at a time like a still photo. Also, you can perform operations such as changing

Enlarging Part of the Image (E-Zoom)

This is useful when you want to expand images to see them in greater detail, such as graphs and tables.

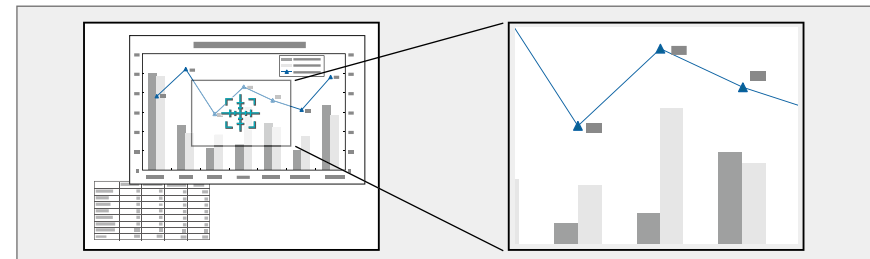

1 Start E-Zoom.

Press the [⊕] button to display the Cross (⊕).

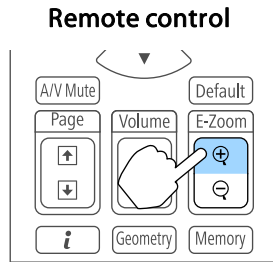

2 Move the Cross (⊕) to the area of the image that you want to enlarge.

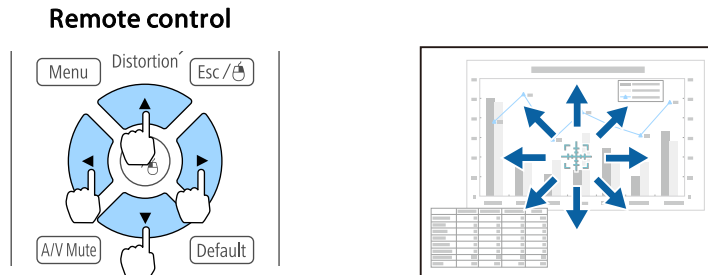

3 Enlarge.

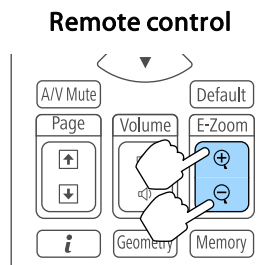

[⊕] button: Expands the area each time it is pressed. You can expand quickly by holding the button down.

[⊖] button: Reduces images that have been enlarged.

[Esc] button: Cancels E-Zoom.



- During enlarged projection, press the [▲], [▼], [◀], or [▶] buttons to scroll the image.
- E-Zoom is unavailable when **Scale** is on.
☛ **Signal - Scale** p.137
- If **4K Enhancement** is enabled, a message is displayed. Select **Yes** to disable **4K Enhancement**. (EB-G7900U/EB-G7400U only)

Saving a User's Logo

You can save the image that is currently being projected as a User's Logo.



Once a User's Logo has been saved, the logo cannot be returned to the factory default.

1 Project the image you want to save as the User's Logo, and then press the [Menu] button.

☛ "Using the Configuration Menu" p.132

2 Select **User's Logo** from **Extended**.



- When **User's Logo Protection** from **Password Protection** is set to **On**, a message is displayed and the User's Logo cannot be changed. You can make changes after setting **User's Logo Protection** to **Off**.
☛ "Managing Users (Password Protection)" p.126
- If **User's Logo** is selected when Geometric Correction, E-Zoom or Aspect are being performed, the function currently being performed is temporarily cancelled.

- 3** When the message "Choose this image as the User's Logo?" is displayed, select **Yes**.



When you press the [] button, the screen size may change depending on the signal to match the actual resolution of the image signal.

- 4** Move the box to select the part of the image to use as the User's Logo.

You can perform the same operations from the projector's control panel.

Remote control

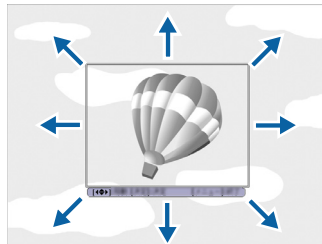
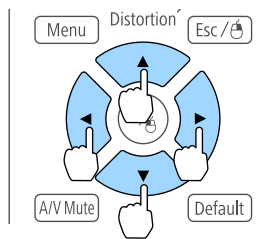

You can save at 400x300 dots in size.

- 5** When you press the [] button and the message "Select this image?" is displayed, select **Yes**.

- 6** Select the zoom factor from the zoom setting screen.

- 7** When the message "Save this image as the User's Logo?" is displayed, select **Yes**.

The image is saved. After the image has been saved, the message "Completed." is displayed.



When a User's Logo is saved, the previous User's Logo is erased.

The settings for the image currently displayed and values for geometric correction are saved as a memory, allowing you to load them when necessary.

Saving/Loading/Erasing/Resetting the Memory

- 1 Press the [Memory] button while projecting.

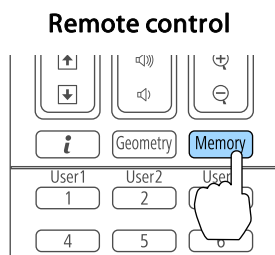

You can also operate from the Configuration menu.

☞ Settings - Memory p.138

- 2 Select a memory type, and then press the [↵] button.

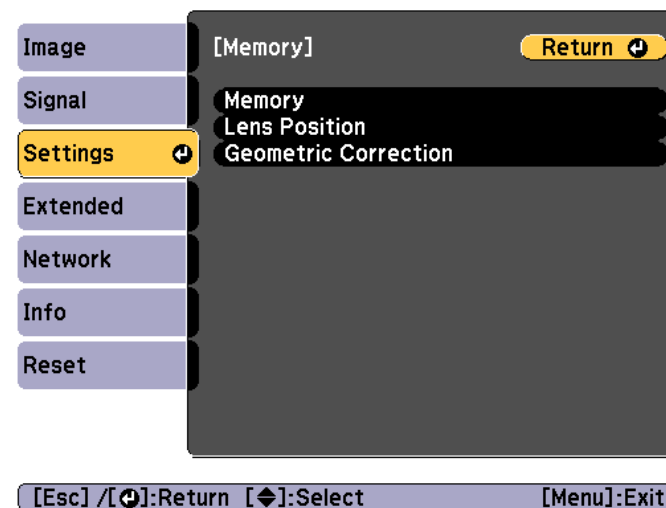

Memory: Settings for the following menu items are saved in the memory. You can register up to 10 values.

Top Menu	Submenu
Image	All setting items
Signal	Scale
Extended	Brightness Level Edge Blending Black Level Color Matching

Lens Position: "Registering and Loading Lens Adjustment Values" p.39

Geometric Correction: Adjustment value of the geometric correction is saved. You can register up to 3 values.

- 3 Select the function you want to perform, then press the [↵] button.

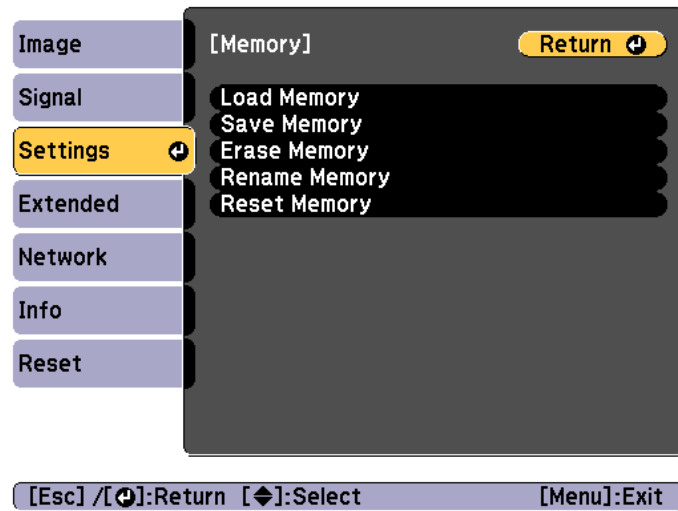

Function	Explanation
Reset Memory	Resets the name and settings of a saved memory. To reset all memories saved in Memory , Lens Position , and Geometric Correction , use Reset All Memories .  Reset - Reset All Memories p.152

 If the mark on the left of the memory name is turned blue, it means the memory has already been registered. When you select a registered memory, a message is displayed asking you to confirm that you want to overwrite the memory. If you select **Yes**, the previous settings are deleted and the current settings are registered.

Function	Explanation
Load Memory	Loads the saved memory. When you select a memory and press the [Left Arrow] button, the settings applied to the current image are replaced with the settings from the memory.
Save Memory	Registers current settings in the memory. When you select a memory name and press the [Left Arrow] button, the settings are saved.
Erase Memory	Erases the registered memory. When you select a memory name and press the [Left Arrow] button, a message is displayed. Select Yes , and then press the [Left Arrow] button to erase the selected memory.
Rename Memory	Changes the memory name. Select the memory name you want to change, and then press the [Left Arrow] button. Enter the memory name using the soft keyboard.  "Soft keyboard operations" p.146 When you have finished, move the cursor over Finish , and then press the [Left Arrow] button.

You can schedule turning the projector power on/off and switching the input source, as events in the schedule. Registered events are executed automatically at the specified time on the specified dates or weekly. You can register up to 30 events.

Saving a Schedule

Setting a schedule

- 1 Press the [Menu] button while projecting.
 ☞ "Using the Configuration Menu" [p.132](#)
- 2 Select **Schedule Settings** from **Extended**.
- 3 Select **Add New** from **Schedule**.

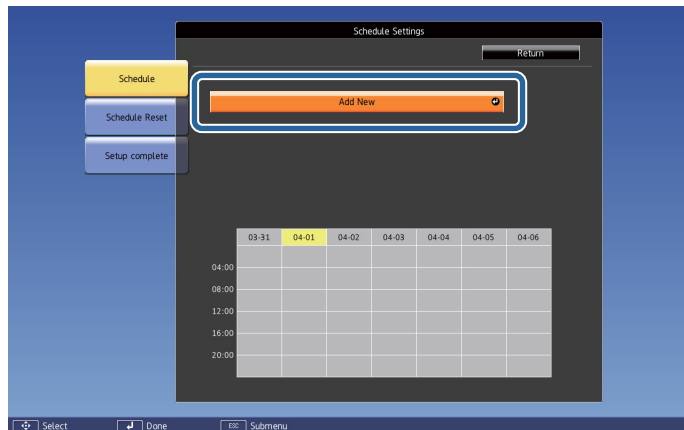

- 4 Set the schedule.

Submenu Name	Function
Event Settings	Select an operation of the projector when the event is executed. Select No Change for items that you do not want to change when the event occurs. You can set the following item operations. <ul style="list-style-type: none"> • Power • Source • Power Consumption • A/V Mute • Volume
Date / Time Settings	Set the date, day of the week, and time to execute the event. Use the soft keyboard to enter the date and time. ☞ "Soft keyboard operations" p.146

- 5 Select **Save**, and then press the [↵] button.

To register additional schedules, repeat steps 3 to 5.



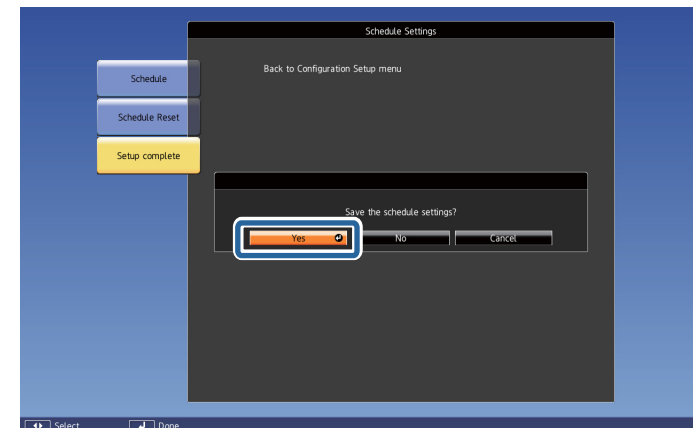

- 6 Select **Setup complete**, and then select **Yes** to finish saving.

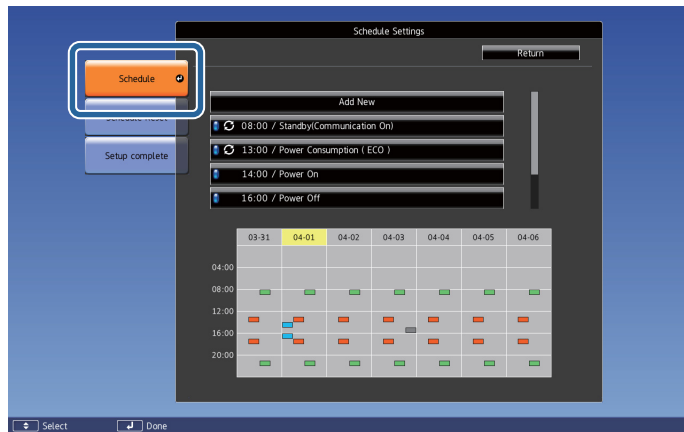

Checking a schedule



- 1 Press the [Menu] button while projecting.
- 2 Select **Schedule Settings** from **Extended**.
The indicator turns on when an event is saved.



-  (Aqua): Single event
-  (Orange): Regular event
-  (Green): Communication monitoring On/Off
-  (Gray): Disabled event

- 3 Press the [◀][▶] buttons to highlight the date you want to check.
The details of the events registered on the selected date are displayed.



-  (Blue): Enabled event
-  (Gray): Disabled event
-  : Regular event

Editing a schedule

- 1 Press the [Menu] button while projecting.
 "Using the Configuration Menu" [p.132](#)
- 2 Select **Schedule Settings** from **Extended**.
- 3 Use the [◀][▶] buttons to highlight the date containing the schedule you want to edit.

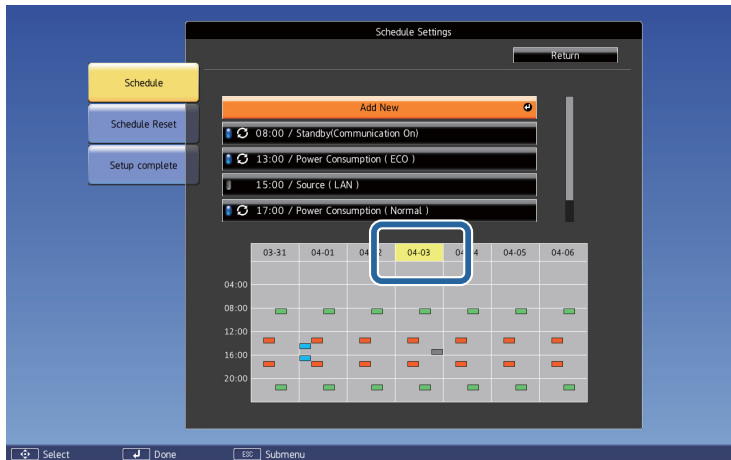

4 Highlight the event you want to edit, and then press the [Esc] button.

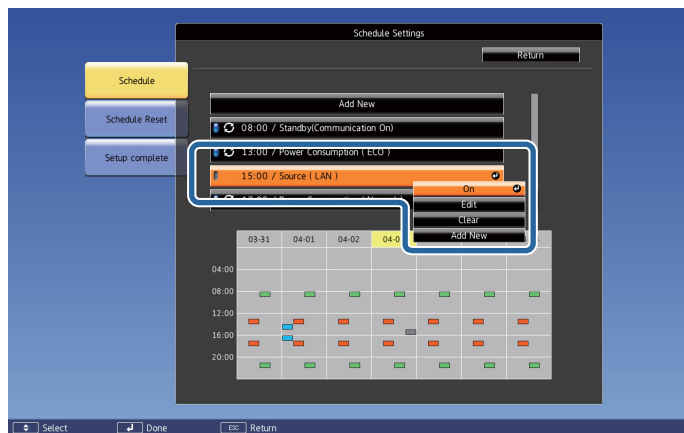



5 Edit the event.

Submenu Name	Function
On/Off	Enable or disable the selected schedule.

Submenu Name	Function
Edit	Edit the content of the selected schedule. Select Save , and then press the [↵] button to complete the editing.
Clear	Deletes the selected schedule.
Add New	Save a new schedule. Select Save , and then press the [↵] button to complete the saving.

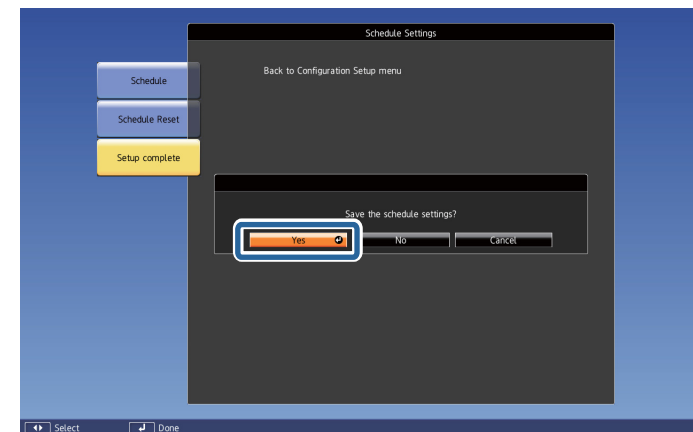
6 Select **Setup complete**, and then select **Yes** to finish editing.



 To delete all registered schedules, select **Schedule Reset**, and then select **Yes**. Select **Setup complete**, and then select **Yes** to delete the schedules.

The projector has the following enhanced security functions.

- **Password Protection**
You can limit who can use the projector.
- **Control Panel Lock/Remote Control Button Lock**
You can prevent people changing the settings on the projector without permission.
☛ "Restricting Operation" [p.128](#)
- **Anti-Theft Lock**
The projector is equipped with the following anti-theft security device.
☛ "Anti-Theft Lock" [p.130](#)

Managing Users (Password Protection)

When Password Protection is activated, people who do not know the password cannot use the projector to project images even if the projector power is on. Furthermore, the user's logo that is displayed when you turn on the projector cannot be changed. This acts as an anti-theft function as the projector cannot be used even if it is stolen. At the time of purchase, Password Protection is not activated.

Kinds of Password Protection

The following four kinds of Password Protect settings can be made according to how the projector is being used.

- **Power On Protection**
When **Power On Protection** is **On**, you need to enter a preset password after the projector is plugged in and turned on (this also applies to Direct Power On). If the correct password is not entered, projection does not start.

- **User's Logo Protection**

Even if someone tries to change the User's Logo set by the owner of the projector, it cannot be changed. When **User's Logo Protection** is set to **On**, the following setting changes for the User's Logo are prohibited.

- Capturing a User's Logo
- Setting **Display Background** or **Startup Screen** from **Display**
☛ **Extended - Display** [p.140](#)

- **Network Protection**

When **Network Protection** is set to **On**, changing the settings for **Network** is prohibited.

- ☛ "Network Menu" [p.145](#)

- **Schedule Protection**

When **Schedule Protection** is set to **On**, changing settings for the projector's system time or schedules is prohibited.

Setting Password Protection

Use the following procedure to set Password Protect.

- 1 During projection, hold down the [Freeze] button for about five seconds.

The Password Protection setting menu is displayed.

Remote control

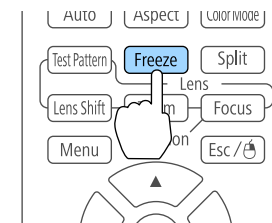



If Password Protection is already activated, you must enter the password.
If the password is entered correctly, the Password Protection setting menu is displayed.

👁️ "Entering the password" [p.127](#)

- 2 Select the type of Password Protect you want to set, and then press the [**↵**] button.

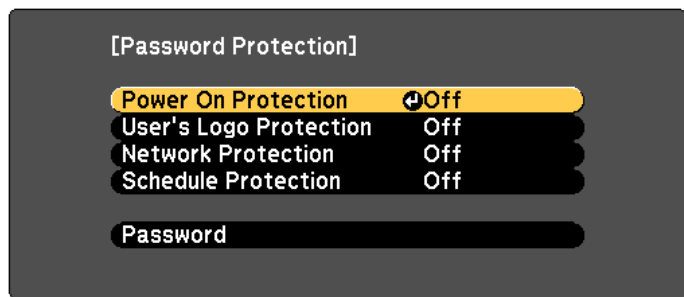

[**↕**]:Select [**↵**]:Enter [**Menu**]:Exit

- 3 Select **On**, and then press the [**↵**] button.
Press the [Esc] button to return to the screen in step 2.

- 4 Set the password.
 - (1) Select **Password**, and then press the [**↵**] button.
 - (2) When the message "Change the password?" is displayed, select **Yes** and then press the [**↵**] button. The default password is set to "0000". Change this to your own desired password. If you select **No**, the screen displayed in step 2 is displayed again.
 - (3) While holding down the [Num] button, enter a four digit number using the numeric buttons. The number entered is displayed as "* * * *". When you enter the fourth digit, the confirmation screen is displayed.

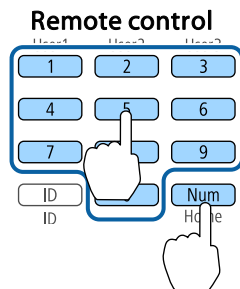

- (4) Re-enter the password.
The message "Password accepted." is displayed.
If you enter the password incorrectly, a message is displayed prompting you to re-enter the password.

Entering the password

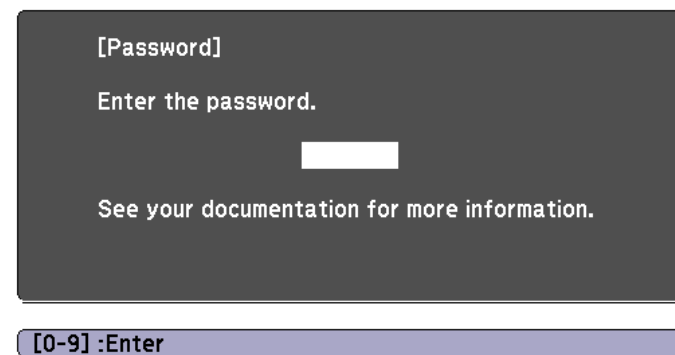

When the password entry screen is displayed, enter the password using the remote control.

While holding down the [Num] button, enter the password by pressing the numeric buttons.



When you enter the correct password, Password Protect is temporarily released.

Attention

- If an incorrect password is entered three times in succession, the message "The projector's operation will be locked." is displayed for approximately five minutes, and then the projector switches to standby mode. If this happens, disconnect the power plug from the electrical outlet and then reinsert it and turn the projector's power back on. The projector displays the password entry screen again so that you can enter the correct password.
- If you have forgotten the password, make a note of the "Request Code: xxxxx" number that appears on the screen and contact the nearest address provided in the Epson Projector Contact List.
 [Epson Projector Contact List](#)
- If you continue to repeat the above operation and input the wrong password thirty times in succession, the following message is displayed and the projector does not accept any more password entries. "The projector's operation will be locked. Contact Epson as described in your documentation."
 [Epson Projector Contact List](#)

Restricting Operation

The following two kinds of operation restriction functions are available with the projector.

- **Control Panel Lock**
This is useful at events or shows when you want to deactivate all buttons during projection or at schools when you want to limit button operation.
- **Lens Lock**
This function deactivates all buttons on the remote control related to the lens operation to prevent improper lens adjustment after it is properly adjusted.
- **Remote control button lock**
This function deactivates buttons except for main buttons needed for basic remote control operation, to prevent mistakes in operations.

Control Panel Lock

Perform one of the following to lock the operation buttons on the control panel. Even if the control panel is locked, you can still use the remote control as usual.

- **Full Lock**
All of the buttons on the control panel are locked. You cannot perform any operations from the control panel, including turning the power on or off.
- **Partial Lock**
All of the buttons on the control panel, except for the [⏻] button, are locked.

- 1** Press the [🔒] button on the control panel during projection to display the Control Panel Lock screen.



You can also make settings in **Control Panel Lock** from the configuration menu.

 [Settings - Lock Setting - Control Panel Lock p.138](#)

- 2** Select either **Full Lock** or **Partial Lock** according to your purpose.

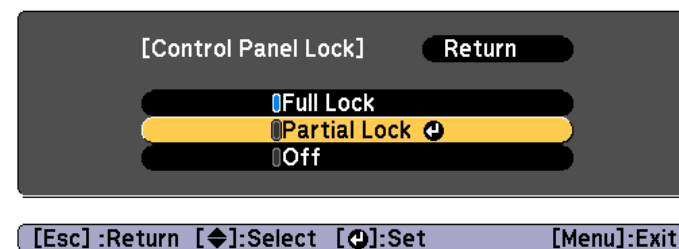

- 3** Select **Yes** when the confirmation message is displayed. The control panel buttons are locked according to the setting you chose.



You can release the control panel lock by one of the following two methods.

- Use the remote control to set **Control Panel Lock** to **Off** from the configuration menu.
 - ☛ **Settings - Lock Setting - Control Panel Lock p.138**
- Press and hold down the [] button on the control panel for about seven seconds, a message is displayed and the lock is released.

Lens Lock

This function locks the following buttons on the remote control related to the lens operation.

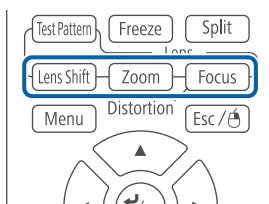



Set the **Lens Lock** to **On** in the Configuration menu.

☛ **Settings - Lock Setting - Lens Lock p.138**

Remote control button lock

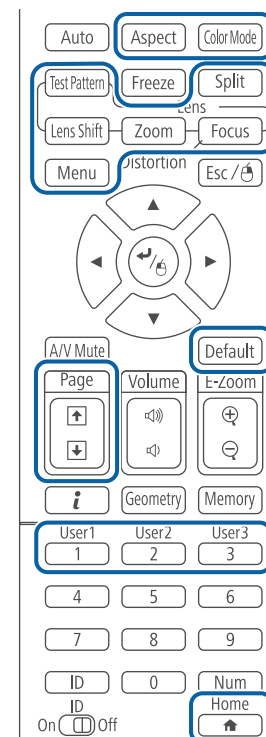
This function locks the following buttons on the remote control.



Each time the [] button is pressed for approximately 5 seconds, the remote control button lock turns on or off.

Remote control

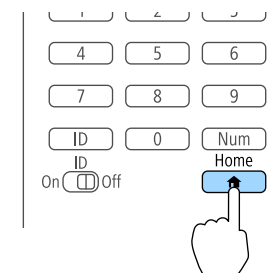



Even if the remote control button lock is on, the following operations are possible.

- Resetting default for the Remote Receiver setting
- Releasing the remote control button lock

Anti-Theft Lock

The projector is equipped with the following types of anti-theft security devices.

- Security slot
The security slot is compatible with the Microsaver Security System manufactured by Kensington.
See the following for more details on the Microsaver Security System.
<http://www.kensington.com/>
- Security cable installation point
A commercially available theft-prevention wire lock can be passed through the installation point to secure the projector to a desk or pillar.

Installing the wire lock

Pass an anti-theft wire lock through the installation point.

See the documentation supplied with the wire lock for locking instructions.

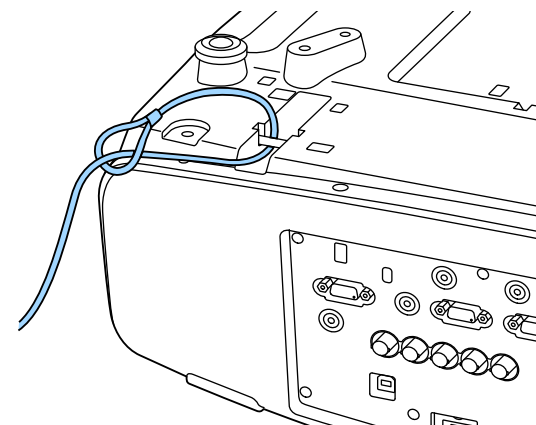

Attention

Do not pass drop-prevention wires through the security cable installation point.



Configuration Menu

This chapter explains how to use the Configuration menu and its functions.

This section explains how to use the Configuration menu.

Although steps are explained using the remote control as an example, you can perform the same operations from the control panel. Check the guide under the menu for the available buttons and their operations.

1 Display the Configuration menu screen.

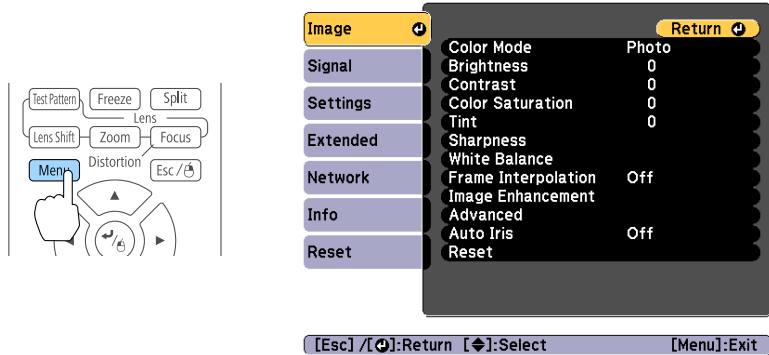

2 Select a top menu item.

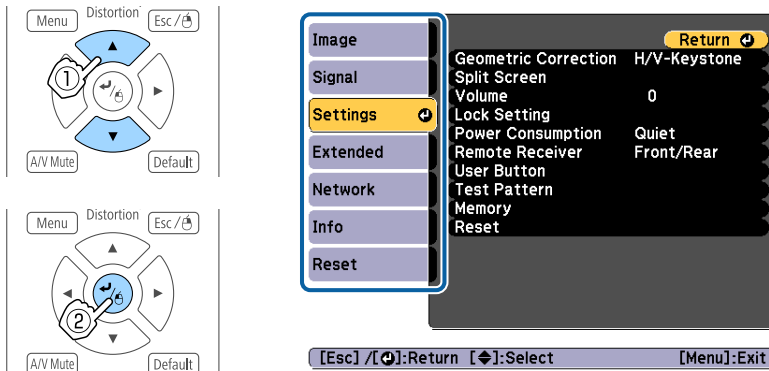

3 Select a submenu item.

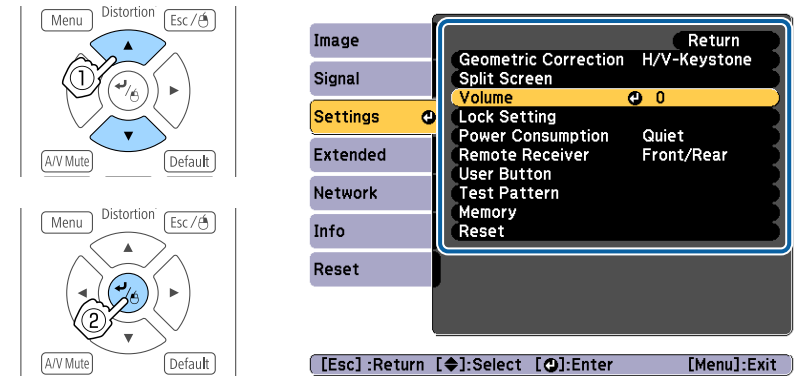

4 Change settings.

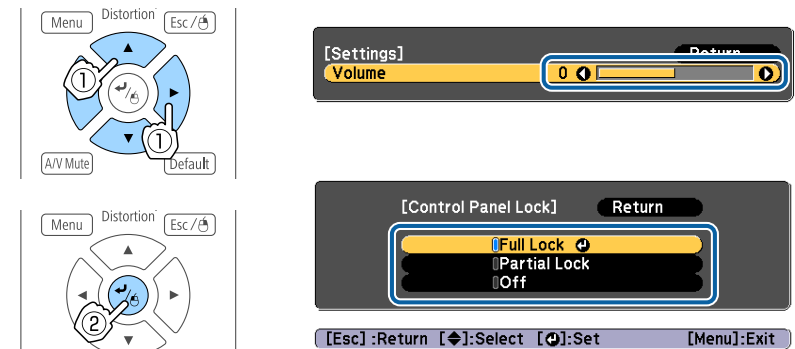

When [Default]: Reset is displayed on the guide, and you press the [Default] button on the remote control, the settings being adjusted are returned to their default values.

5 Press the [Menu] button to finish making settings.

Configuration Menu Table

Settable items vary depending on the model being used and the image signal and source being projected.

Top Menu Name	Submenu Name	Items or Setting Values
Image menu ☛ p.135	Color Mode	Dynamic, Presentation, Cinema, sRGB, DICOM SIM, Multi-Projection
	Brightness	0 to 100
	Contrast	0 to 100
	Color Saturation	0 to 100
	Tint	0 to 100
	Sharpness	Standard, Thin Line Enhancement, Thick Line Enhancement
	White Balance	Color Temp., G-M Correction, Customized
	Frame Interpolation	Off, Low, Normal, and High
	Image Enhancement	4K Enhancement, Image Preset Mode, Noise Reduction, MPEG Noise Reduction, Super-resolution, Detail Enhancement
	Advanced	Gamma, RGBCMY, Deinterlacing
Auto Iris	Off, Normal, and High Speed	
Signal menu ☛ p.137	Resolution	Auto, Wide, Normal, and Manual
	Aspect	Auto, Normal, 4:3, 16:9, Full, H-Zoom, V-Zoom, Native
	Tracking	-
	Sync.	0 to 31
	Position	-128 to 127
	Auto Setup	On and Off

Top Menu Name	Submenu Name	Items or Setting Values
	Overscan	Auto, Off, 4%, and 8%
	Blanking	Top, Bottom, Left, and Right
	Advanced	Video Range, Input Signal, Image Processing
	Scale	Scale, Scale Mode, Scale Vertically, Scale Horizontally, Clip Adjustment, Clip Range
Settings menu ☛ p.138	Geometric Correction	Off, H/V-Keystone, Quick Corner, Curved Surface, Corner Wall, Point Correction, Memory
	Split Screen	-
	Volume	0 to 20
	Lock Setting	Control Panel Lock, Lens Lock
	Power Consumption	Normal, ECO
	Remote Receiver	Front/Rear, Front, Rear, and Off
	User Button	User Button 1, User Button 2, and User Button 3
	Test Pattern	Standard, Cross-hatching, Color Bars V, Color Bars H, Grayscale, Gray Bars V, Gray Bars H, Checkerboard 1, Checkerboard 2, White, Black, Aspect Frame
	Memory	Memory, Lens Position, Geometric Correction
	Extended menu ☛ p.140	Home Screen
Display		Menu Position, Message Position, Messages, Display Background, Startup Screen, Standby Confirmation, Air Filter Notice, Screen, Panel Alignment, Color Uniformity, OSD Rotation

Top Menu Name	Submenu Name	Items or Setting Values
	User's Logo	-
	Projection	Front, Front/Ceiling, Rear, and Rear/Ceiling
	Direction	Direction, Portrait Mode
	Operation	Direct Power On, Sleep Mode, Sleep Mode Timer, High Altitude Mode, Auto Source Search, Auto Power On, A/V Mute Settings, Advanced, Date & Time, Lens Calibration
	A/V Settings	A/V Output, Monitor Out, and Audio Settings
	Standby Mode	Communication On and Communication Off
	HDBaseT	Control Communications, Extron XTP
	Multi-Projection	Projector ID, Tiling, Geometric Correction, Edge Blending, Scale, Color Mode, Brightness Level, Color Matching, Color Uniformity, RBGCMY, Black Level
	Schedule Settings	-
	Language	27 languages
Info menu ☛ p.152	Projector Info	Source, Input Signal, Resolution, Refresh Rate, Sync Info, Status, Serial Number, Lens Type, Event ID, HDBaseT Signal Level
	Lamp Info	Lamp Hours
	Version	Main, Video2

Top Menu Name	Submenu Name	Items or Setting Values
	Status Information	Status Information, Source, Signal Information, Network Wired, Network Wireless, Maintenance, Version
Reset menu ☛ p.153	Reset Lamp Hours	-
	Reset All Memories	-
	Reset All Config	-

Network menu

Top Menu Name	Submenu Name	Items or Setting Values
Basic menu ☛ p.147	Projector Name	-
	PJLink Password	-
	Remote Password	-
	Web Control Password	-
	Projector Keyword	On and Off
	Display LAN Info.	Text & QR Code, Text
Wireless LAN menu ☛ p.147	Connection Mode	Quick, Advanced
	Search Access Point	-
	SSID	-
	Security	Open, WPA2-PSK, WPA/WPA2-PSK
	Passphrase	-
	Channel	1ch, 6ch, and 11ch
	IP Settings	DHCP, IP Address, Subnet Mask, Gateway Address
	SSID Display	On and Off





Top Menu Name	Submenu Name	Items or Setting Values
	IP Address Display	On, Off
Wired LAN menu  p.150	IP Settings	DHCP, IP Address, Subnet Mask, Gateway Address
	IP Address Display	On, Off
Notification menu  p.151	Mail Notification	On, Off
	SMTP Server	-
	Port Number	-
	From	-
	Address 1 Setting, Address 2 Setting, Address 3 Setting	Email Address, No Signal, System Error, Lamp Error, High Temp Error, Air Filter Error, Replace Lamp, High Temp Warning, Air Filter Warning, Other Warning, Air Filter Notice
	SNMP	On, Off
	Trap IP Address 1, Trap IP Address 2	-
Others menu  p.151	Community Name	-
	Priority Gateway	Wired LAN, Wireless LAN
	AMX Device Discovery	On and Off
	Crestron RoomView	On and Off
	Control4 SDDP	On and Off
	Message Broadcasting	On and Off

Image Menu

Settable items vary depending on the image signal and source currently being projected. Setting details are saved for each color mode.

 "Automatically Detecting Input Signals and Changing the Projected Image (Source Search)" p.59

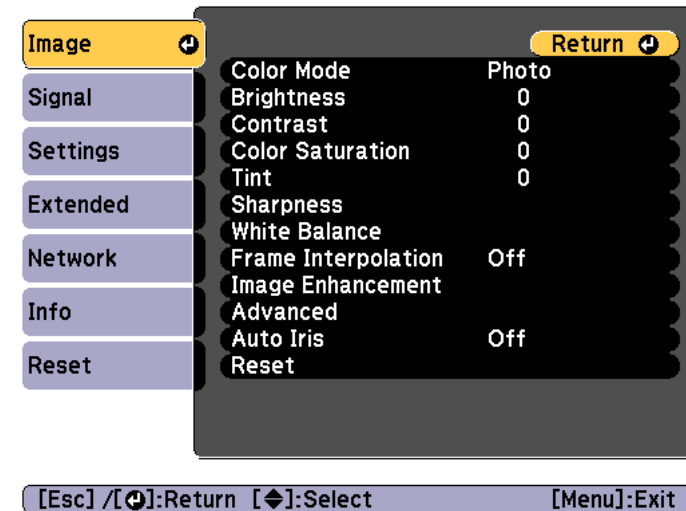

Submenu	Function
Color Mode	You can select the quality of the image to suit your surroundings.  "Selecting the Projection Quality (Selecting Color Mode)" p.86
Brightness	You can adjust the image brightness.
Contrast	You can adjust the difference between light and dark in the images.
Color Saturation	You can adjust the color saturation for the images.
Tint	You can adjust the image tint.

Submenu	Function
Sharpness	<p>Standard: You can adjust the image sharpness.</p> <p>Thin Line Enhancement: If this parameter is set to a positive value, details such as hair or fabric patterns will be enhanced.</p> <p>Thick Line Enhancement: If this parameter is set to a positive value, the outline, background, and the other main parts of the objects in the image will be enhanced to show them clearly.</p>
White Balance	<p>You can adjust the overall tint of the image.</p> <p>Color Temp.: You can adjust the overall tint of the image. When the Color Mode is set to sRGB or DICOM SIM, adjust to 11 steps in 3200K, 5000K to 10000K. When the Color Mode is set to anything other than sRGB and DICOM SIM, you can adjust it in a range of 0 to 10. The image is tinted blue when a high value is selected and tinted red when a low value is selected.</p> <p>G-M Correction: The color tone is tinted red when set to a negative value, and tinted green when set to a positive value.</p> <p>Customized: You can adjust the offset and gain of each color R (red), G (green), and B (blue) individually.</p>
Frame Interpolation *1, 2, 3, 4, 5, 6, 7	You can play fast moving images smoothly by producing intermediate frames between the original frames.

Submenu	Function
Image Enhancement	<p>You can adjust the image resolution.</p> <p> "Adjusting Image Resolution (Image Enhancement)" p.95</p> <p>4K Enhancement*8: You can project at a doubled resolution.</p> <p>Image Preset Mode: You can select the optimal setting according to the projected image from five presets prepared in advance.</p> <p>Noise Reduction*2, 3, 7: You can smooth out the roughness in progressive images.</p> <p>MPEG Noise Reduction*2, 3: You can reduce dot and block noise that occurs in outlines when projecting MPEG movies.</p> <p>Super-resolution: To display a crisp image, you can reduce the blurring that is created on the edge when the resolution of the image signal is scaled up and projected.</p> <p>Detail Enhancement: You can enhance the contrast of details in an image.</p>
Advanced	<p>You can make adjustments by choosing the following items.</p> <p>Gamma: You can adjust the coloring by selecting one of the gamma correction values, or referring to the projected image or a gamma graph.</p> <p>RGBCMY: You can adjust the hue, saturation, and brightness of each color R (red), G (green), B (blue), C (cyan), M (magenta), Y (yellow) individually.</p> <p>Deinterlacing*7, 10: You can convert interlace signals into progressive signals. (IP conversion)</p> <p>Off is ideal for images with a large amount of movement, Video for general video images, and Film/Auto for movie films, computer graphics, and animation.</p>
Auto Iris *4, 9	Set to Normal or High Speed to adjust the iris to obtain the optimum light for images being projected. Select High Speed to make faster iris corrections to match the speed of the scene.



Submenu	Function
Reset	You can reset all adjustment values for the Image menu to their default settings. See the following to return all menu items to their default settings.  "Reset Menu" p.153

- *1 This cannot be set when E-Zoom is used.
- *2 This cannot be set when the signal input exceeds WUXGA.
- *3 This cannot be set when 4K Enhancement is enabled.
- *4 This cannot be set when **Edge Blending** is **On**.
- *5 This cannot be set when **Scale** is enabled.
- *6 This cannot be set when **Image Processing** is set to **Fast 1**.
- *7 This cannot be set when **Image Processing** is set to **Fast 2**.
- *8 This can be set only for EB-G7900U/EB-G7400U
- *9 This can be set only if **Color Mode** is set to **Dynamic** or **Cinema**.
- *10 This can be set only when the input signal is 480i, 576i, or 1080i.

Signal Menu

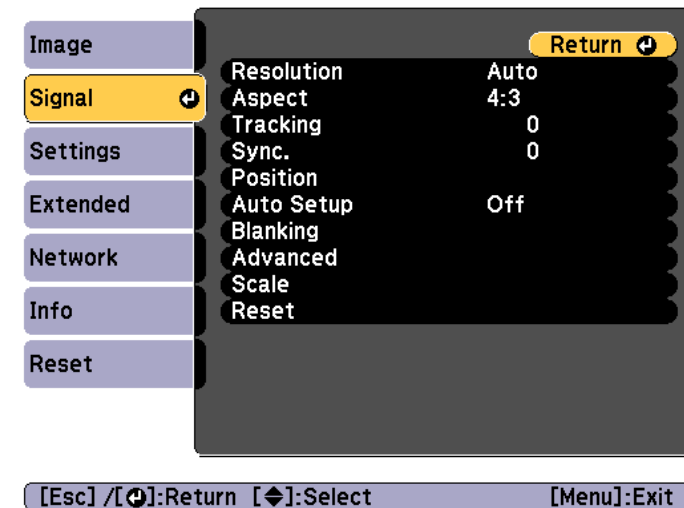
Settable items vary depending on the image signal and source currently being projected. Setting details are saved for each image signal.



Submenu	Function
Resolution	(Only available when an analog RGB computer signal is being input.) Set to Auto to automatically identify the resolution of the input signal. If images are not projected correctly when set to Auto , for example if some of the image is missing, set to Wide for wide screens, or set to Normal for 4:3 or 5:4 screens depending on the connected computer. Manual allows you to specify the resolution. This is ideal when connected computer is fixed.
Aspect	You can set the Aspect Ratio  for projected images.  "Changing the Aspect Ratio of the Projected Image" p.87
Tracking	(Only available when an analog RGB computer signal is being input.) You can adjust computer images when vertical stripes appear in the images.

Submenu	Function
Sync.	(Only available when an analog RGB computer signal is being input.) You can adjust computer images when flickering, fuzziness, or interference appear in the images.
Position	You can adjust the display position up, down, left, and right when a part of the image is missing so that the whole image is projected.
Auto Setup	(Only available when an analog RGB computer signal is being input.) Set to On to automatically adjust Tracking, Sync., and Position to the optimum state when the input signal changes.
Overscan	Changes the output image ratio (the range of the projected image). You can set the cropping range to 4% or 8% . When set to Auto , this is automatically adjusted according to the input signal.
Blanking	You can hide images in the set area. Use the [◀][▶] buttons to adjust the area. You can adjust by using a combination of Top , Bottom , Left , and Right .
Advanced	You can set by choosing the following items. Video Range: Select the video range for the input signal from the HDMI port, DVI-D port, or HDBaseT port. Set to Expanded if you are concerned about misadjusted black levels or blown out highlights in the image. Input Signal: Select an input signal from the Computer port or BNC port. If set to Auto , the input signal is set automatically according to the connected equipment. If colors do not appear correctly when set to Auto , select the appropriate signal according to the connected equipment. Image Processing: Changes settings for image processing. <ul style="list-style-type: none"> • Fine: When Frame Interpolation is On, Frame Interpolation is enabled. • Fast 1: Images are displayed quicker without any loss in image quality. • Fast 2: Images are displayed quicker than Fast 1.

Submenu	Function
Scale	When using multiple projectors to project one image, adjust the range of the image displayed by each projector. ☛ "Displaying a Scaled Image" p.111
Reset	You can reset all adjustment values on the Signal menu to their default settings, except for Input Signal . See the following to return all menu items to their default settings. ☛ "Reset Menu" p.153

Settings Menu

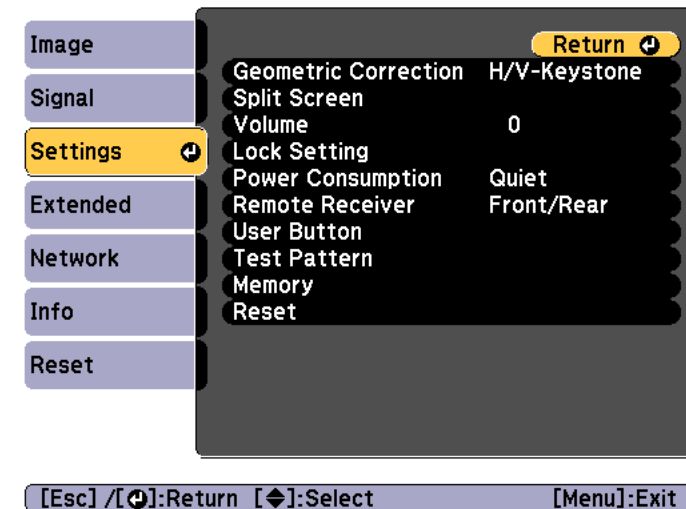

Submenu	Function
Geometric Correction	<p>You can correct distortion.</p> <p>☛ "Correcting Distortion in the Projected Image" p.62</p> <ul style="list-style-type: none"> • Off: Temporarily cancels the geometric correction. • H/V-Keystone: Adjust V-Keystone, V-Balance, H-Keystone, and H-Balance to correct vertical and horizontal keystone distortion. • Quick Corner: Select and correct the four corners of the projected image. • Curved Surface: Corrects distortion that occurs when projecting on a curved surface. • Corner Wall: Corrects distortion that occurs when projecting on a surface with right angles. • Point Correction: Divides the projected image into a grid and corrects the distortion by moving the selected point of intersection from side to side and up and down. • Memory: You can save the adjustment value of the geometric correction and load it when needed. ☛ "Memory Function" p.121
Split Screen	<p>You can split the screen into two screens.</p> <p>☛ "Projecting Two Images Simultaneously (Split Screen)" p.114</p>
Volume	<p>You can adjust the volume. Setting values are saved for each source.</p>

Submenu	Function
Lock Setting	<p>Control Panel Lock: You can use this to restrict operation of the projector's control panel. ☛ "Control Panel Lock" p.128</p> <p>Lens Lock: When set to On, [Lens Shift], [Zoom], and [Focus] button operations on the remote control are disabled. ☛ "Lens Lock" p.129</p>
Power Consumption*1 *2	<p>When set to ECO, the power consumption during projection drops and the fan noise is reduced.</p>
Remote Receiver	<p>You can limit the reception of the operation signal from the remote control.</p> <p>When set to Off, you cannot perform any operations from the remote control. If you want to make operations from the remote control, hold down the [Menu] button on the remote control for at least 15 seconds to reset the setting to its default value.</p>
User Button	<p>Select the items in the Configuration menu that you want to assign to the [User1], [User2], and [User3] buttons on the remote control. The following items can be assigned. Power Consumption*1, Multi-Projection, Resolution, Image Processing, On-Screen Display, Display the QR Code, Image Enhancement, Frame Interpolation</p>
Test Pattern	<p>You can display a test pattern to adjust the projection without connecting other equipment when you set up the projector. ☛ "Displaying a Test Pattern" p.32</p>
Memory	<p>Perform operations and make settings for the memory function. ☛ "Memory Function" p.121</p>

Submenu	Function
Reset	<p>You can reset all adjustment values on the Settings menu to their default settings, except for User Button and Memory.</p> <p>See the following to return all menu items to their default settings.</p> <p>☛ "Reset Menu" p.153</p>

*1 Not available for EB-G7400U.

*2 This cannot be set when **Portrait Mode** is set to **On**.

Submenu	Function
Home Screen	<p>Home Screen Auto Disp.: When set to On, the Home screen is displayed when the projector turns on. The Home screen is not displayed when the selected source has an image signal when the projector turns on.</p> <p>Custom Function 1, Custom Function 2: Select functions to be assigned to the Home screen from the following five functions. Power Consumption*1, Network Settings, Info, Frame Interpolation, Split Screen</p>

Extended Menu

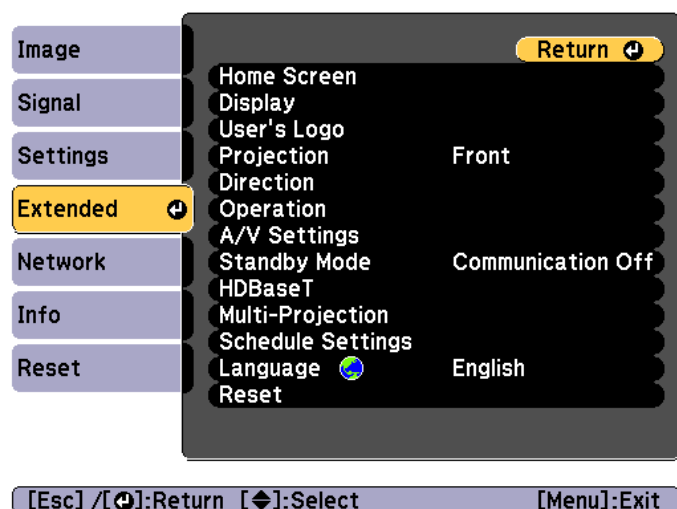

Submenu	Function
Display	<p>You can make settings related to the projector's display.</p> <p>Menu Position: Select the position to display the menu on the projected screen.</p> <p>Message Position: Select the position to display the message on the projected screen.</p> <p>Messages: When set to Off, the following items will not be displayed.</p> <p>Item names when the Source, Color Mode, or Aspect is changed, messages when no signal is being input, and warnings such as High Temp Warning.</p> <p>Display Background*2: You can set the screen status for when no image signal is available to Black, Blue, or Logo.</p> <p>Startup Screen*2: Set to On to display the User's Logo when projection starts.</p> <p>Standby Confirmation: (This is unavailable when the Remote Control Type is set to Simple.) If it is set to Off, you can turn off the power simply by pressing the [⏻] button once.</p> <p>Air Filter Notice: You can set whether or not (On/Off) to enable Air Filter Notice. When this is set to On and a clog in the air filter is detected, the message is displayed on the screen.</p> <p>Screen: (This setting is unavailable when projecting images from a computer over a network.) Set the aspect ratio and position of the projected screen according to the type of screen being used.</p> <p>☛ "Screen Settings" p.30</p> <p>Panel Alignment: Correct color misalignments (red and blue) in the screen.</p> <p>☛ "Panel Alignment" p.197</p> <p>Color Uniformity: Adjusts the color tone balance for the whole screen.</p> <p>☛ "Color Uniformity" p.198</p> <p>OSD Rotation: Rotates the menu direction by 90 degrees.</p>

Submenu	Function
User's Logo *2	<p>You can change the user's logo that is displayed as a background during Display Background, A/V Mute, and so on.</p> <p>☛ "Saving a User's Logo" p.119</p>
Projection	<p>Select from one of the following projection methods depending on how the projector is installed.</p> <p>Front, Front/Ceiling, Rear, and Rear/Ceiling</p> <p>You can change the setting as follows by pressing down the [A/V Mute] button for about five seconds.</p> <p>Front↔Front/Ceiling</p> <p>Rear↔Rear/Ceiling</p>
Direction	<p>Set this parameter according to the installation status of the projector.*3</p> <p>☛ "Installation Settings" p.28</p> <p>For portrait installation, set Portrait Mode to On.</p>











Submenu	Function
Operation	<p>Direct Power On: Set to On to turn on the projector simply by plugging it in.</p> <p>When the power cord is plugged in, note that the projector turns on automatically in cases such as a power outage being restored.</p> <p>Sleep Mode: When set to On, this automatically stops projection when no image signal is being input and no operations are carried out.</p> <p>Sleep Mode Timer: When Sleep Mode is set to On, you can set the time before the projector automatically turns off within a range of 1 to 30 minutes.</p> <p>High Altitude Mode: Set to On when using the projector above an altitude of 1,500 m.</p> <p>Auto Source Search: Set to On to automatically detect an image signal from another source and project the image when there is no image signal from the current source.</p> <p>Auto Power On: If it is set to Computer or BNC, the projector is turned on when the signals are received from the Computer port or BNC port, even when the projector is in standby status.</p> <p>A/V Mute Settings: Perform settings related to A/V mute.</p> <ul style="list-style-type: none"> • Fade-in: Specify the number of seconds for fade-in when displaying an image. • Fade-out: Specify the number of seconds for fade-out when hiding an image. • A/V Mute Timer: When it is set to On, if no operations are performed for about 2 hours after A/V mute is activated, the projector turns off automatically. • A/V Mute Release: When it is set to A/V Mute, you can release A/V mute only by pressing the [A/V Mute] button (or by sending an A/V mute Off command). When set to Any Button, A/V mute is released when any operation is performed on the projector.



Submenu	Function
	<p> "Hiding the Image and Sound Temporarily (A/V Mute)" p.117</p> <p>Advanced: The following items can be set.</p> <ul style="list-style-type: none"> • BNC Sync Termination: Set the termination for the signal from the BNC port. This should usually be set to Off. Set to On when analog (75Ω) termination such as for switchers is necessary. • Remote Control Type: You can select Normal or Simple depending on the type of remote control. Set this item to Normal to use the remote control provided with this projector. When Simple is selected, you can use the remote control provided with other Epson projectors to operate this projector. This is useful if you want to use a remote control that you are already familiar with to operate the projector. However, you cannot use the remote control provided with this projector if this is set to Simple. Make sure that the setting is correct because, if the projector is mounted on the ceiling or somewhere hard to reach, changing it back to Normal may be difficult. Additionally, you cannot use the functions that are not equipped with this projector or the remote control which you use. • Beep: When this is set to On, the confirmation buzzer beeps to notify you that the power turns on or off, or cooling down is finished. • Indicators: When set to Off, the projector's indicators are turned off, except for abnormality or warning. • Instant Off: When set to Enabled, the projector goes into standby status in approximately three seconds after Power Off. If you turn the power on immediately after turning it off, command communication may be cut off. To stabilize command communication, set this to Disabled. When set

Submenu	Function
	<p>to Disabled, the projector goes into standby status in approximately 75 seconds after power off.</p> <ul style="list-style-type: none"> • Inv Direction Button: Set this to On when the projector is installed on a ceiling. • HDMI DDC Buffer: If the image from a device connected using an HDMI extension cable is not displayed correctly, turning this On may improve the image. • DVI-D DDC Buffer: If the image from a device connected using a DVI extension cable is not displayed correctly, turning this On may improve the image. • Lens Type: When using the following lens, select the model number of the lens. ELPLS04, ELPLU02, ELPLR04, ELPLW04, ELPLM06, ELPLM07, ELPLL07 <p>Date & Time: Make system time settings for the projector. ☛ "Setting the Time" p.43</p> <p>Lens Calibration: Acquires the information of the lens installed on the projector.</p>

Submenu	Function
A/V Settings	<p>A/V Output: Set this to Always On if you want to output audio and images to an external device even when the projector is in standby status.</p> <p>Monitor Out: Select the image source output to an external monitor when the projector is in standby status. When set to Auto, analog RGB signals from the Computer port or the BNC port are output depending on which source was selected when the projector was turned off.</p> <p>Audio Settings: Perform the following audio related settings.</p> <ul style="list-style-type: none"> • Audio Output: Select the audio to be output when projecting images from the Computer port, BNC port, or DVI-D port. When set to Auto, audio is output from the audio input port corresponding to each image input port. ☛ "Connecting Equipment" p.46 • HDMI Audio Output: Select the audio source when projecting images from the HDMI port. If you select HDMI, audio for the image is output as it is. If you select Audio3, audio is output from the Audio3 port.
Standby Mode	<p>If you set Communication On, you can perform the following operations even if the projector is in standby mode.</p> <ul style="list-style-type: none"> • Monitor and control the projector over a network. • Output audio and images to an external device. (Only when A/V Output is set to Always On.) • Communication from the HDBaseT port is enabled. (Only when Control Communications is set to On.) <div style="border: 1px solid black; padding: 5px; margin-top: 10px;">  <p>When monitoring or controlling the projector using wireless LAN, set Connection Mode to Advanced.</p> <p>☛ Network - Wireless LAN - Connection Mode p.147</p> </div>

Submenu	Function
HDBaseT	<p>Control Communications: (This cannot be set when Extron XTP is set to On.) When set to On, Ethernet communication, serial communication, and the wired remote control through the HDBaseT Transmitter connected to the HDBaseT port are all enabled.</p> <p>Extron XTP: Set to On when you connect the Extron XTP transmitter or switcher to the HDBaseT port. See the following Extron Web site for more details on the XTP system. http://www.extron.com/</p> <div style="border: 1px solid black; padding: 5px; margin-top: 10px;">  <ul style="list-style-type: none"> • When Control Communications or Extron XTP is set to On, Standby Mode is automatically set to Communication On. • When Control Communications or Extron XTP is On, the projector's LAN port, RS-232 port, and Remote port are disabled. • When Extron XTP is set to On, the fan may rotate in standby mode but this is not abnormal. </div>

Submenu	Function
Multi-Projection	<p>Make settings when projecting from multiple projectors.  "Multi-Projection Function" p.101</p> <p>Projector ID: Set the ID from 1 to 30. Off indicates that no ID is set.  "ID Settings" p.41</p> <p>Tiling: Set the number of split screens and positions of each projected image.  "Tiling" p.110</p> <p>Geometric Correction: Corrects distortion in the projected image.  "Correcting Distortion in the Projected Image" p.62</p> <p>Edge Blending: Corrects a border between multiple images to create a seamless screen.  "Edge Blending" p.101</p> <p>Scale: When using multiple projectors to project one image, adjust the range of the image displayed by each projector.  "Displaying a Scaled Image" p.111</p> <p>Color Mode: Set to Multi-Projection.</p> <p>Brightness Level*1: When the brightness of each lamp differs, set the lamp brightness level. This item can be adjusted only when Power Consumption is set to Normal from the Settings menu.  "Correcting the Brightness (EB-G7900U/EB-G7200W/EB-G7000W/EB-G7800 only)" p.104</p> <p>Color Matching: Corrects the difference between the tint and brightness of each projected image.  "Color Matching" p.105</p> <p>Color Uniformity: Adjusts the color tone balance for the whole screen.  "Color Uniformity" p.198</p> <p>RGBCMY: You can adjust the Hue, Saturation, and Brightness for R (red), G (Green), B (Blue), C (Cyan), M (Magenta), and Y (Yellow) color components.  "Adjusting RGBCMY" p.106</p>

Submenu	Function
	<p>Black Level: Adjusts the differences in brightness and tone for areas where images overlap and areas where the images do not overlap.  "Black Level" p.107</p> <p>Reset: You can reset all adjustment values for the Multi-Projection menu to their default settings.</p>
Schedule Settings	<p>You can set the projector's schedule so that it performs a specific operation at a pre-scheduled time.  "Scheduling Function" p.123</p>
Language	You can set the language for messages and menus.
Reset	<p>You can reset all adjustment values for the Extended menu to their default settings. However, the following items are not reset. Screen Type, Screen Position, Projection, Direction, Portrait Mode, High Altitude Mode, Auto Source Search, A/V Mute Release, Remote Control Type, Inv Direction Button, Lens Type, A/V Output, Monitor Out, Standby Mode, Control Communications, Extron XTP, Projector ID, Color Mode, Color Matching, Language</p> <p>See the following to return all menu items to their default settings.  "Reset Menu" p.153</p>

*1 Not available for EB-G7400U.

*2 When **User's Logo Protection** is set to **On** in **Password Protection**, you cannot change settings related to user's logo. You can make changes after setting **User's Logo Protection** to **Off**.

 "Managing Users (Password Protection)" [p.126](#)

*3 This cannot be set when **Portrait Mode** is set to **On**.

Network Menu

When **Network Protection** is set to **On** in **Password Protection**, a message is displayed and the network settings cannot be changed. Set **Network Protection** to **Off** and then configure the network.

 "Setting Password Protection" [p.126](#)

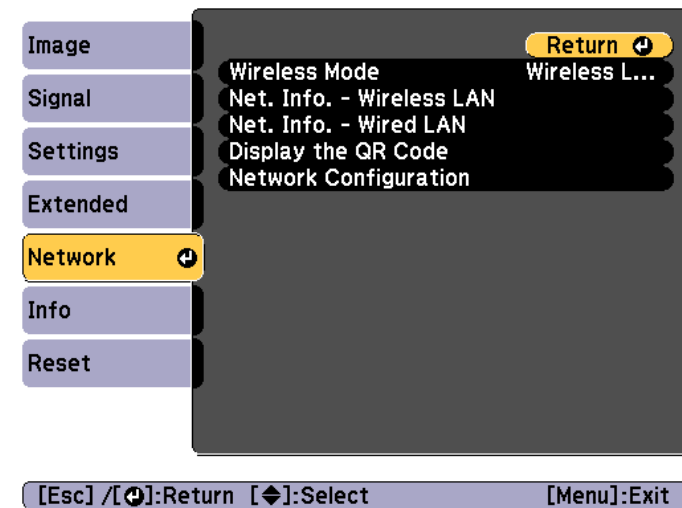

Submenu	Function
Wireless Mode	Set this to Wireless LAN On when connecting the projector and a computer via a wireless LAN. If you do not want to connect via wireless LAN, turn it Off to prevent unauthorized access by others.

Submenu	Function
Net. Info. - Wireless LAN	Displays the following network setting status information. <ul style="list-style-type: none"> • Connection Mode • Wireless LAN Sys. • Antenna Level • Projector Name • SSID • DHCP • IP Address • Subnet Mask • Gateway Address • MAC Address • Region Code
Net. Info. - Wired LAN	Displays the following network setting status information. <ul style="list-style-type: none"> • Projector Name • DHCP • IP Address • Subnet Mask • Gateway Address • MAC Address
Display the QR Code	Displays the QR code.
Network Configuration	The following menus are available for setting Network items. Basic, Wireless LAN, Wired LAN, Notification, Others, Reset

Notes on operating the Network menu

Selecting from the top menu and sub menus, and changing selected items is the same as making operations from the Configuration menu.

When done, make sure you go to the **Complete** menu, and select **Yes**, **No**, or **Cancel**. When you select **Yes** or **No**, you are returned to the Configuration menu.



Yes: Saves the settings and exits the Network menu.

No: Does not save the settings and exits the Network menu.

Cancel: Continues displaying the Network menu.

Soft keyboard operations

The Network menu contains items that require input of alphanumeric during setup. In this case, the following software keyboard is displayed. Use [Up Arrow][Down Arrow][Left Arrow][Right Arrow] buttons to move the cursor to the desired key, and then press the [Enter] button to enter the selected character. Enter figures by holding down the [Num] button on the remote control, and pressing the numeric buttons. After inputting, press **Finish** on the keyboard to confirm your input. Press **Cancel** on the keyboard to cancel your input.



- Each time the **CAPS** key is selected and the [Enter] button is pressed, it sets and changes between upper case and lower case letters.

- Each time the **SYM1/2** key is selected and the [**↵**] button is pressed, it sets and changes the symbol keys for the section enclosed by the frame.

The following types of character can be entered.

Numbers	0123456789
Letters	ABCDEFGHIJKLMNOPQRSTUVWXYZ abcdefghijklmnopqrstuvwxyz
Symbols	! " # \$ % & ' () * + , - . / : ; < = > ? @ [\] ^ _ ` { } ~

Basic menu

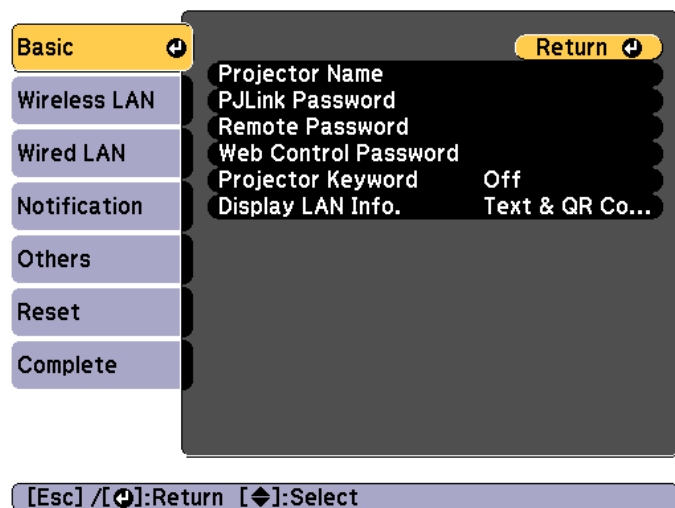

Submenu	Function
Projector Name	The projector's name is displayed when using the supplied application EasyMP Multi PC Projection. When editing, you can enter up to 16 single-byte alphanumeric characters. (" * + , / : ; < = > ? [\] ` and spaces cannot be used.)

Submenu	Function
PJLink Password	Set a password to use when you access the projector using compatible PJLink software. You can enter up to 32 single-byte alphanumeric characters. (Spaces and symbols cannot be used.) ☛ "About PJLink" p.210
Remote Password	Set a password to use Remote in Epson Web Control. You can enter up to 8 single-byte alphanumeric characters. (* : and spaces cannot be used.) The default user name is "EPSONREMOTE" and the default password is "guest". ☛ "Changing Settings Using a Web Browser (Epson Web Control)" p.202
Web Control Password	Set a password for authentication to use when making settings and controlling the projector using Web Control in Epson Web Control. You can enter up to eight single-byte alphanumeric characters (* : and spaces cannot be used). The default user name is "EPSONWEB" and the default password is "admin". ☛ "Changing Settings Using a Web Browser (Epson Web Control)" p.202
Projector Keyword	When set to On , you have to enter the keyword when you try to connect the projector to a computer via a network. As a result, you can prevent presentations from being interrupted by connections from other computers. Normally this should be set to On . ☛ <i>EasyMP Multi PC Projection Operation Guide</i>
Display LAN Info.	Set the display format for the projector's network information. If you display the QR code, you can connect to a network just by reading the QR code in Epson iProjection. Text & QR Code is set by default.

Wireless LAN menu

To connect the projector to a computer using a wireless LAN, install the Wireless LAN unit (ELPAP10).

☛ "Installing the Wireless LAN Unit" p.52

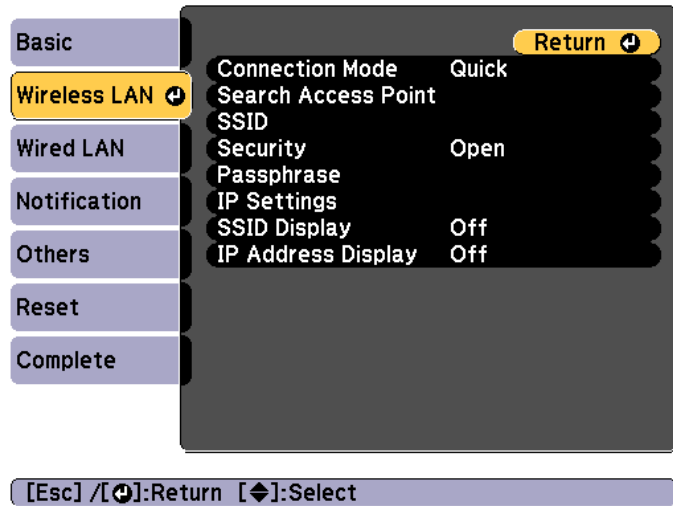

Submenu	Function
Connection Mode	Set the connection mode to use when connecting the projector and a computer via a wireless LAN. Quick: Lets you directly connect to a smartphone, tablet, or computer via a wireless LAN. Advanced: Lets you connect to a smartphone, tablet, or computer over a wireless LAN access point. The connection is established in infrastructure mode.
Search Access Point	When Connection Mode is set to Advanced , you can search for surrounding access points, and set the SSID to be connected from those access points. Depending on the access point settings, they may not be displayed in the list. ☛ "Search Access Point screen" p.149
SSID	Enter an SSID. When an SSID is provided for the wireless LAN system in which the projector participates, enter the SSID. You can enter up to 32 single-byte alphanumeric characters.

Submenu	Function
Security	Select the security type according to the wireless LAN settings. When setting security, follow the instructions of your network administrator.
Passphrase	Enter a passphrase used to connect to the network when Security is set to WPA2-PSK or WPA/WPA2-PSK . You can enter at least 8 and up to 63 single-byte alphanumeric characters. You can enter up to 32 characters on the Configuration menu. When entering more than 32 characters, use your Web browser to enter the text. ☛ "Changing Settings Using a Web Browser (Epson Web Control)" p.202 When Connection Mode is set to Quick , the initial passphrase is set.
Channel	You can select the channels used to connect in Quick mode. If interference from other signals occurs, use a different channel.

Submenu	Function
IP Settings	<p>(This can only be set if Connection Mode is set to Advanced.) Configure the network.</p> <p>DHCP: Set to On to configure the network using <u>DHCP</u>▶▶ If this is set to On, you cannot set any more addresses.</p> <p>IP Address: You can enter the <u>IP address</u>▶▶ assigned to the projector. You can enter a number from 0 to 255 in each field of the address. However, the following IP addresses cannot be used. 0.0.0.0, 127.x.x.x, 224.0.0.0 to 255.255.255.255 (where x is a number from 0 to 255)</p> <p>Subnet Mask: You can enter the <u>Subnet Mask</u>▶▶ for the projector. You can enter a number from 0 to 255 in each field of the address. However, the following subnet masks cannot be used. 0.0.0.0, 255.255.255.255</p> <p>Gateway Address: You can enter the IP address for the gateway for the projector. You can enter a number from 0 to 255 in each field of the address. However, the following <u>Gateway Address</u>▶▶ cannot be used. 0.0.0.0, 127.x.x.x, 224.0.0.0 to 255.255.255.255 (where x is a number from 0 to 255)</p>
SSID Display	To prevent the SSID from being displayed on the LAN Standby screen, set this to Off .
IP Address Display	To prevent the IP address from being displayed on the LAN Standby screen, set this to Off .

Type of security

When the optional wireless LAN unit is attached and being used in Advanced connection mode, it is strongly recommended that you set security.

WPA is an encryption standard that improves the security for wireless networks. The projector supports TKIP and AES encryption methods.

WPA also includes user authentication functions. WPA authentication provides two methods: using an authentication server, or authenticating

between a computer and an access point without using a server. This projector supports the latter method, without a server.





For setting details, follow the instructions from your network administrator.

Search Access Point screen

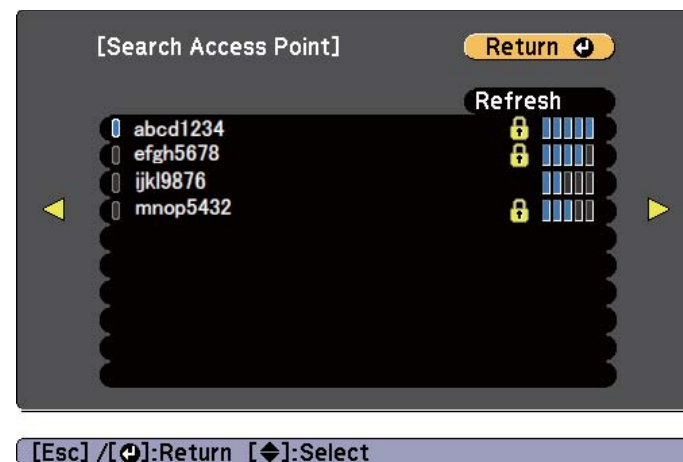
Detected access points are displayed in a list.



Submenu	Function
Refresh	Searches for the access point again.
	Indicates an already set access point.
	Indicates the access points where security is set. If you select an access point where security has not been set, the Wireless LAN menu is displayed. If you select an access point where security has been set, the Security menu is displayed. Select a type of security according to the security settings for the access point.

Wired LAN menu

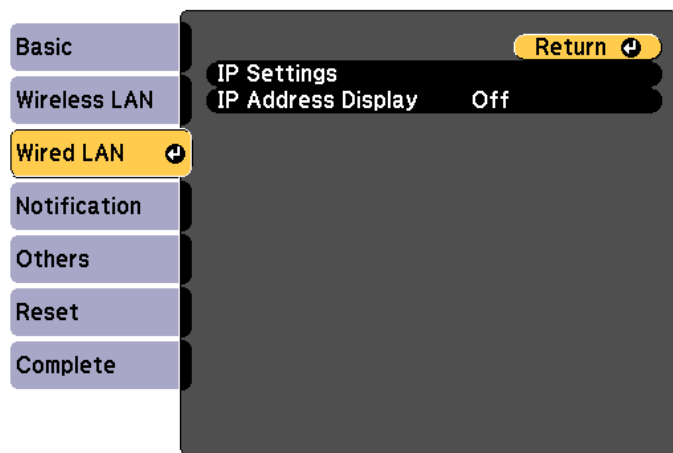

[Esc] / [Return]:Return [Left/Right]:Select

Submenu	Function
IP Settings	<p>You can make settings related to the following addresses.</p> <p>DHCP: Set to On to configure the network using DHCP. If this is set to On, you cannot set any more addresses.</p> <p>IP Address: You can enter the IP address assigned to the projector. You can enter a number from 0 to 255 in each field of the address. However, the following IP addresses cannot be used. 0.0.0.0, 127.x.x.x, 224.0.0.0 to 255.255.255.255 (where x is a number from 0 to 255)</p> <p>Subnet Mask: You can enter the Subnet Mask for the projector. You can enter a number from 0 to 255 in each field of the address. However, the following subnet masks cannot be used. 0.0.0.0, 255.255.255.255</p> <p>Gateway Address: You can enter the IP address for the gateway for the projector. You can enter a number from 0 to 255 in each field of the address. However, the following Gateway Address cannot be used. 0.0.0.0, 127.x.x.x, 224.0.0.0 to 255.255.255.255 (where x is a number from 0 to 255)</p>

Submenu	Function
IP Address Display	To prevent the IP address from being displayed on the LAN Standby screen, set this to Off .

Notification menu

When this is set, you receive an email notification if a problem or warning occurs in the projector.

☛ "Reading error notification mail" [p.207](#)

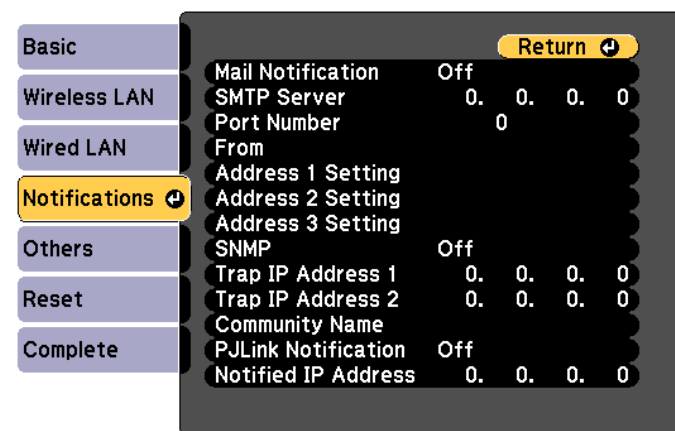

[Esc] / [Return]:Return [Left/Right]:Select

Submenu	Function
Mail Notification	Set to On to send an email to the preset addresses when a problem or warning occurs with a projector.
SMTP Server	<p>You can input the IP Address for the SMTP server for the projector.</p> <p>You can enter a number from 0 to 255 in each field of the address. However, the following IP addresses cannot be used. 127.x.x.x, 224.0.0.0 to 255.255.255.255 (where x is a number from 0 to 255)</p>

Submenu	Function
Port Number	You can input the port number for the SMTP server. The default value is 25. You can input numbers between 1 to 65535.
From	Enter the email address of the sender.
Address 1 Setting/Address 2 Setting/Address 3 Setting	Set the destination email addresses for the notification email, and the notification content. You can register up to three destinations. You can enter up to 32 single-byte alphanumeric characters for the email addresses. (" () , ; > [\] and spaces cannot be used.)
SNMP	Set to On to monitor the projector using SNMP . To monitor the projector, you need to install the SNMP manager program on your computer. SNMP should be managed by a network administrator. The default value is Off .
Trap IP Address 1/Trap IP Address 2	You can register up to two IP addresses for the SNMP trap notification destination. You can enter a number from 0 to 255 in each field of the address. However, the following IP addresses cannot be used. 127.x.x.x, 224.0.0.0 to 255.255.255.255 (where x is a number from 0 to 255)
Community Name	Set the community name of SNMP. You can enter up to 32 single-byte alphanumeric characters. (Spaces and symbols cannot be used.)
PJLink Notification	Set this to On to use the PJLink notification function.
Notified IP Address	Enter the IP address of the computer to which you want to send notifications of the projector's operating status using the PJLink notification function. You can enter a number from 0 to 255 in each field of the address. However, the following IP addresses cannot be used. 127.x.x.x, 224.0.0.0 to 255.255.255.255 (where x is a number from 0 to 255)

Others menu

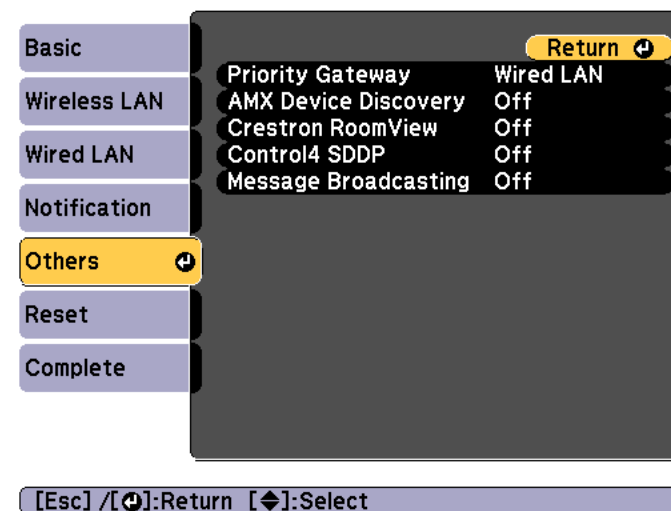

Submenu	Function
Priority Gateway	For the priority gateway, select either Wired or Wireless .
AMX Device Discovery	When you want to allow the projector to be detected by AMX Device Discovery , set this to On . Set this to Off if you are not connected to an environment controlled by a controller from AMX or AMX Device Discovery.
Crestron RoomView	Set this to On only when monitoring or controlling the projector over the network using Crestron RoomView®. Otherwise, set this to Off . ☛ "About Crestron RoomView®" p.210 Changes in projector settings take effect upon restarting. When this is set to On , the following functions are not available. <ul style="list-style-type: none"> • Epson Web Control • Message Broadcasting (EasyMP Monitor plugin)
Control4 SDDP	Set to On if you want to enable the acquisition of the device information by Control4® Simple Device Discovery Protocol (SDDP) .

Submenu	Function
Message Broadcasting	<p>You can switch the Message Broadcasting function to enable or disable.</p> <p>You can download Message Broadcasting and its Operation Guide from the following Web site. http://www.epson.com</p>

Reset menu

Resets all of the network settings.

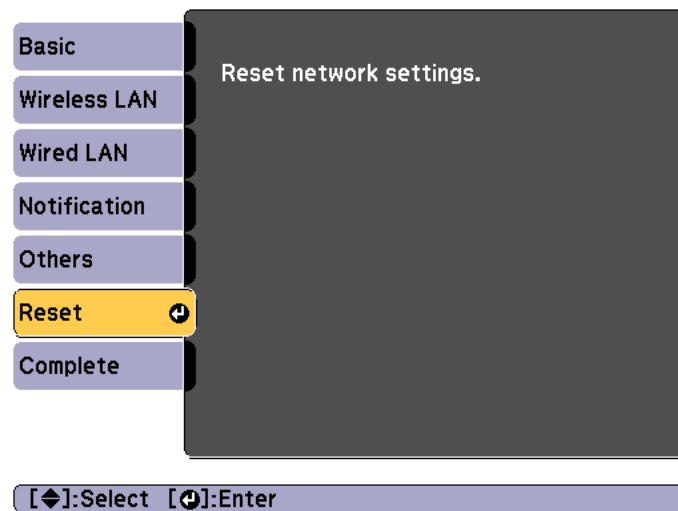

Submenu	Function
Reset network settings.	To reset all of the Network settings, select Yes .

Info Menu (Display Only)

Lets you check the status of the image signals being projected and the status of the projector. Items that can be displayed vary depending on the source currently being projected.

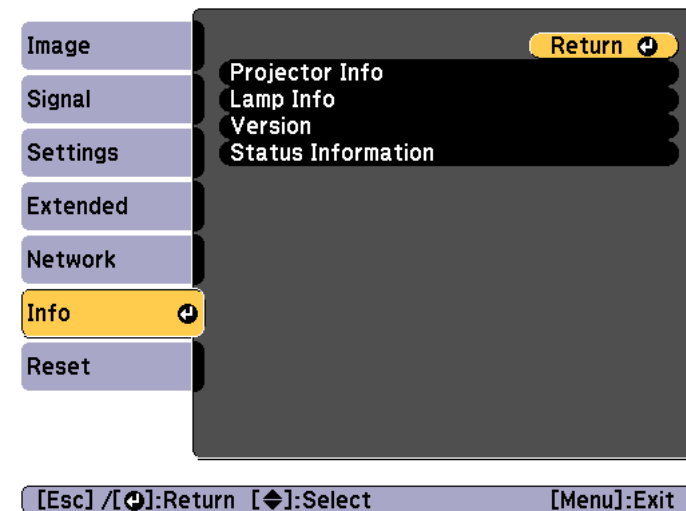

Submenu	Function
Projector Info	<p>Source You can display the source name for the connected equipment currently being projected.</p> <p>Input Signal You can display the content of Input Signal set in the Signal menu according to the source.</p> <p>Resolution You can display the resolution.</p> <p>Refresh Rate You can display the <u>Refresh Rate</u>▶▶.</p> <p>Sync Info You can display the image signal information. This information may be needed if service is required.</p>

Submenu		Function
	Status	This is information about errors that have occurred on the projector. This information may be needed if service is required.
	Serial Number	Displays the projector's serial number.
	Lens Type	Displays the model number of your lens.
	Event ID	When problems occur when the projector and computer are connected through the network, information on the problem is displayed using an Event ID. See the following page for information on interpreting the Event ID. ☛ "About Event ID" p.187
	HDBaseT Signal Level	You can display the image signal information from the HDBaseT port.
Lamp Info	Lamp Hours	You can display the cumulative lamp operating time*. When the lamp replacement time is reached, the characters are displayed in yellow.
Version	Main Video2	Displays the projector's firmware version information.
Status Information		Displays the projector's status. ☛ "Reading the Status Information" p.170

* The cumulative use time is displayed as "0H" for the first 10 hours. 10 hours and above is displayed as "10H", "11H", and so on.

Reset Menu

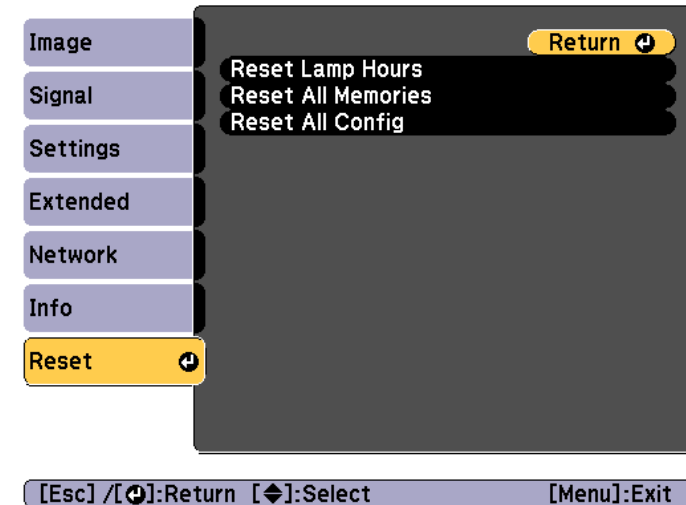

Submenu	Function
Reset Lamp Hours	Clears the cumulative lamp hours use time. Reset when you replace the lamp.
Reset All Memories	Resets all names and settings saved in Memory , Lens Position , and Geometric Correction . ☛ "Memory Function" p.121
Reset All Config	You can reset all items in the Configuration menu to their default settings. The following items are not reset to their defaults: Input Signal , Memory , User's Logo , all items for Network menus, Lamp Hours , Language , Date & Time , Panel Alignment , Color Uniformity , and Color Matching .

Once the Configuration menu content has been set for one projector, you can use it to perform batch setup for multiple projectors (batch setup function). The batch setup function is only for projectors with the same model number.

Use one of the following methods.

- Setup using a USB flash drive.
- Setup by connecting the computer and projector with a USB cable.
- Setup using EasyMP Network Updater.

This manual explains the USB flash drive and the USB cable methods.



- The following content is not reflected by the batch setup function.
 - The Network menu settings (except for the Notification menu and the Others menu)
 - Lamp Hours and Status in the Info menu
- Perform batch setup before adjusting the projected image. Adjustment values for the projected image, such as Geometric Correction are reflected by the batch setup function. If batch setup is performed after adjusting the projected image, the adjustments you made may change.
- By using the batch setup function, the registered User's Logo is set for the other projectors. Do not register confidential information and so on as the User's Logo.



Caution

Performing batch setup is the customers responsibility. If batch setup fails due to a power failure, communication error, and so on, the customer is responsible for any repair costs incurred.

Setup Using a USB Flash Drive

This section explains how to perform batch setup using a USB flash drive.



- Use a FAT format USB flash drive.
- The batch setup function cannot be used by USB flash drives that incorporate security functions. Use a USB flash drive that does not incorporate security functions.
- The batch setup function cannot be used by USB card readers or USB hard disks.

Saving settings to the USB flash drive

- 1** Disconnect the power cord from the projector, and check that all of the projector's indicators have turned off.
- 2** Connect the USB flash drive to the projector's wireless LAN unit port.
 - "Installing the Wireless LAN Unit" [p.52](#)

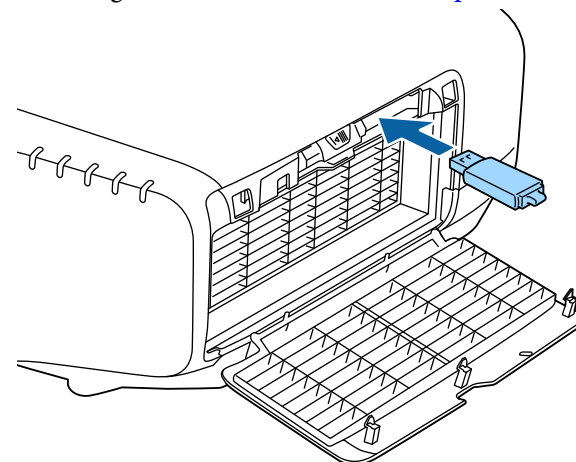



- Connect the USB flash drive directly to the projector. If the USB flash drive is connected to the projector through a USB hub, the settings may not be saved correctly.
- Connect an empty USB flash drive. If the USB flash drive contains data other than the batch setup file, the settings may not be saved correctly.
- If you have saved a batch setup file from another projector to the USB flash drive, delete the file or change the file name. The batch setup function cannot overwrite a batch setup file.
- The file name for the batch setup file is PJCONFDATA.bin. If you need to change the file name, add text after PJCONFDATA. If you change the file name in any other way, the projector may not be able to recognize the file correctly.
- You can only use single-byte characters for the file name.

3 While holding down the [Esc] button on the remote control or the control panel, connect the power cord to the projector.

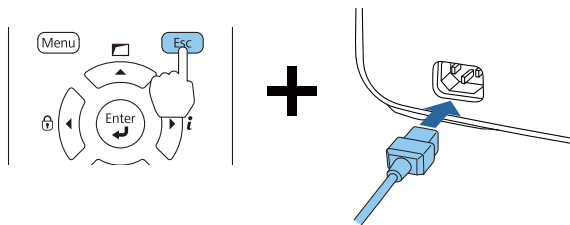

When the projector's indicators turn on as follows, release the [Esc] button.

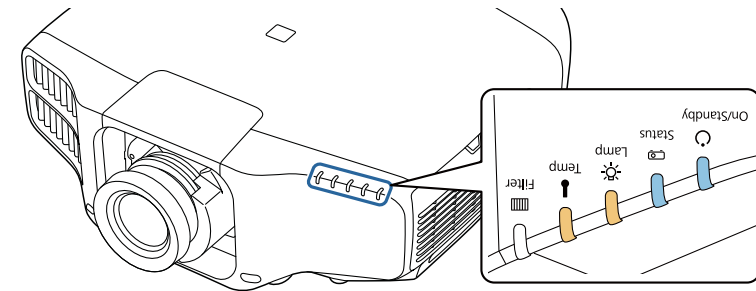

Power	Status	Lamp	Temp
Blue - On	Blue - On	Orange - On	Orange - On

When all of the indicators start flashing, the batch setup file is being written.

Caution

- Do not disconnect the power cord from the projector while the file is being written. If the power cord is disconnected, the projector may not start correctly.
- Do not disconnect the USB flash drive from the projector while the file is being written. If the USB flash drive is disconnected, the projector may not start correctly.

When writing completes normally, the projector enters standby status.

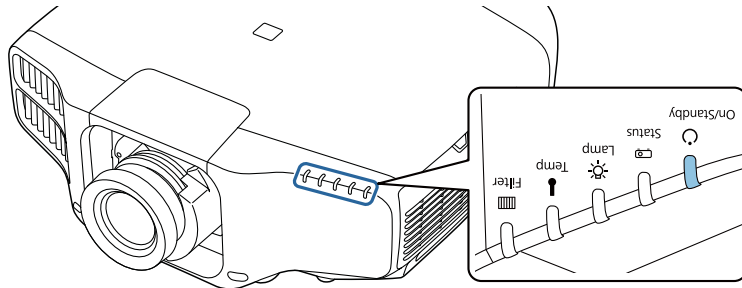

Power
Blue - On

When the projector is in standby status, remove the USB flash drive.

Reflecting saved settings to other projectors

- 1** Disconnect the power cord from the projector, and check that all of the projector's indicators have turned off.
- 2** Connect the USB flash drive containing the saved batch setup file to the projector's wireless LAN unit port.

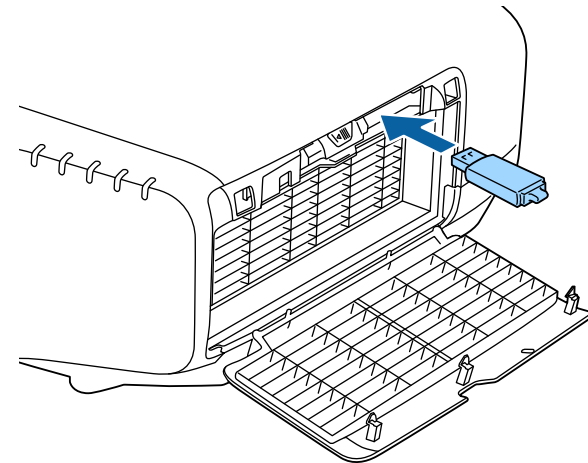

- When the USB flash drive contains 1 to 3 types of batch setup files, the file is reflected to the projector with the same model number. If there are multiple files for a projector with the same model number, the settings may not be reflected correctly.
- When there are four or more types of batch setup files on the USB flash drive, the settings may not be reflected correctly.
- Do not store any data except for the batch setup file on the USB flash drive. If the USB flash drive contains data other than the batch setup file, the settings may not be reflected correctly.

- 3** While holding down the [Menu] on the remote control or the control panel, connect the power cord to the projector.

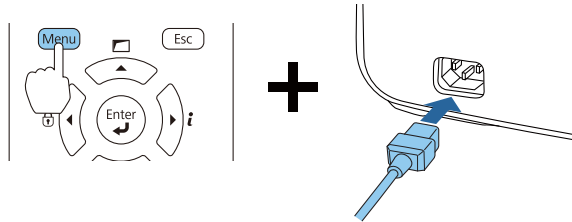

When the projector's indicators turn on as follows, release the [Menu] button.

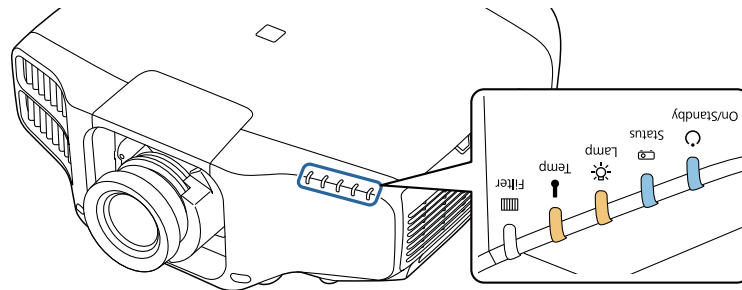

Power	Status	Lamp	Temp
Blue - On	Blue - On	Orange - On	Orange - On

The indicators remain on for about 75 seconds.

When all of the indicators start flashing, the settings are being written.

⚠ Caution

- Do not disconnect the power cord from the projector while the settings are being written. If the power cord is disconnected, the projector may not start correctly.
- Do not disconnect the USB flash drive from the projector while the settings are being written. If the USB flash drive is disconnected, the projector may not start correctly.

- 4** When writing completes normally, the projector enters standby status.

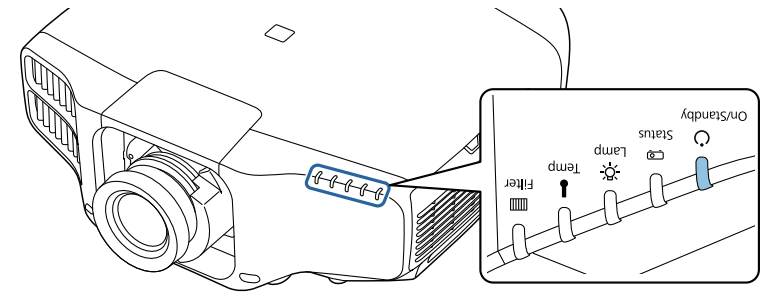

Power
Blue - On

When the projector is in standby status, remove the USB flash drive.

Setup by Connecting the Computer and Projector with a USB Cable



The following operating systems support the batch setup function.

- Windows Vista or later
- Mac OS X 10.5.3 or later

Saving settings to a computer

- 1 Disconnect the power cord from the projector, and check that all of the projector's indicators have turned off.
- 2 Connect the computer's USB port to the projector's Service port with a USB cable.

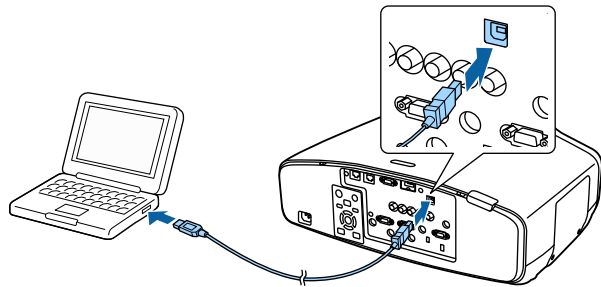

- 3 While holding down the [Esc] button on the remote control or the control panel, connect the power cord to the projector.

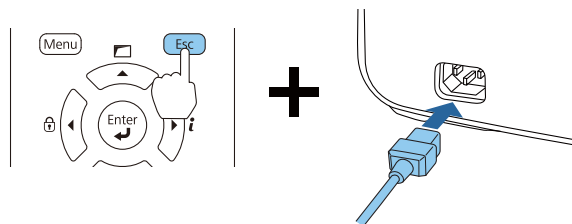

When the projector's indicators turn on as follows, release the [Esc] button.

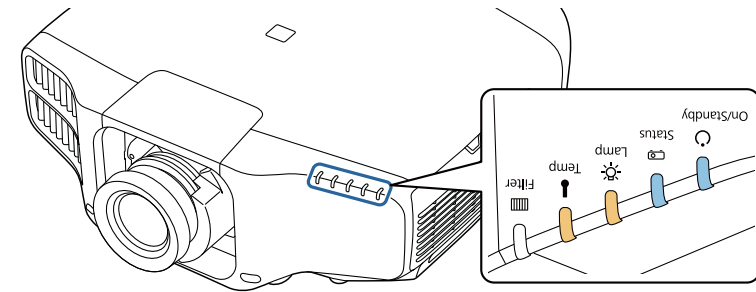

Power	Status	Lamp	Temp
Blue - On	Blue - On	Orange - On	Orange - On

The projector is recognized as a removable disk by the computer.

- 4 Open the removable disk, and save the batch setup file (PJCONFDATA.bin) to the computer.



If you need to change the name of the batch setup file, add text after PJCONFDATA. If you change the file name, the projector may not be able to recognize the file correctly.

- 5 Perform "Remove USB device" on your computer, and then disconnect the USB cable.



When using OS X, perform "Remove EPSON_PJ".

The projector enters standby status.

Reflecting saved settings to other projectors

- 1** Disconnect the power cord from the projector, and check that all of the projector's indicators have turned off.
- 2** Connect the computer's USB port to the projector's Service port with a USB cable.

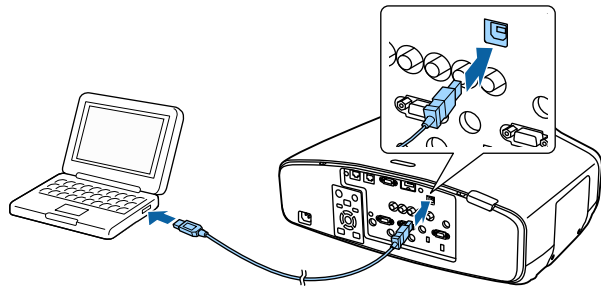

- 3** While holding down the [Menu] on the remote control or the control panel, connect the power cord to the projector.

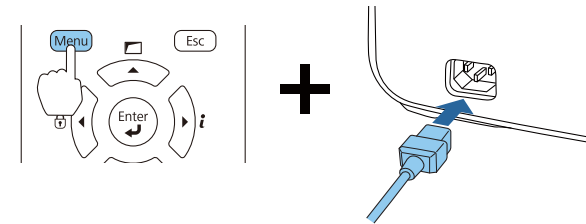

When the projector's indicators turn on as follows, release the [Menu] button.

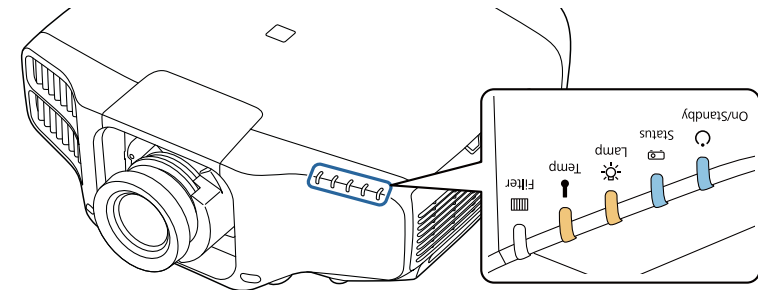

Power	Status	Lamp	Temp
Blue - On	Blue - On	Orange - On	Orange - On

The projector is recognized as a removable disk by the computer.

- 4** Copy the batch setup file (PJCONFDATA.bin) that you saved to your computer to the top level folder of the removable disk.



Do not copy any files or folders other than the batch setup file to the removable disk.

- 5** Perform "Remove USB device" on your computer, and then disconnect the USB cable.



When using OS X, perform "Remove EPSON_PJ".

When all of the indicators start flashing, the settings are being written.



Caution

Do not disconnect the power cord from the projector while the settings are being written. If the power cord is disconnected, the projector may not start correctly.

When writing completes normally, the projector enters standby status.

When Setup Fails

The indicators notify you if an error occurs. Check the status of the indicators.

Status of the Indicators	Remedy
<p>Lamp: Orange - flashing fast Temp: Orange - flashing fast</p>	<p>The batch setup file may be corrupt, or the USB flash drive may not be connected correctly. Disconnect the USB flash drive, unplug and then plug in the projector's power cord, and then try again.</p>
<p>Power: Blue - flashing fast Status: Blue - flashing fast Lamp: Orange - flashing fast Temp: Orange - flashing fast</p>	<p>Writing the settings may have failed and an error may have occurred in the projector's firmware. Stop using the projector, remove the power plug from the electrical outlet, and contact your local dealer or the nearest address provided in the Epson Projector Contact List. Epson Projector Contact List</p>



Troubleshooting

This chapter explains how to identify problems and what to do if a problem is found.

If a problem occurs with the projector, you can display the Help screen to assist you. You can also set the projector to an appropriate state by answering the questions.

1 Press the [**Home**] button.

The Home screen is displayed.

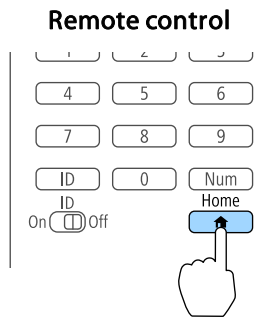

2 Select Help, and then press the [**Enter**] button.

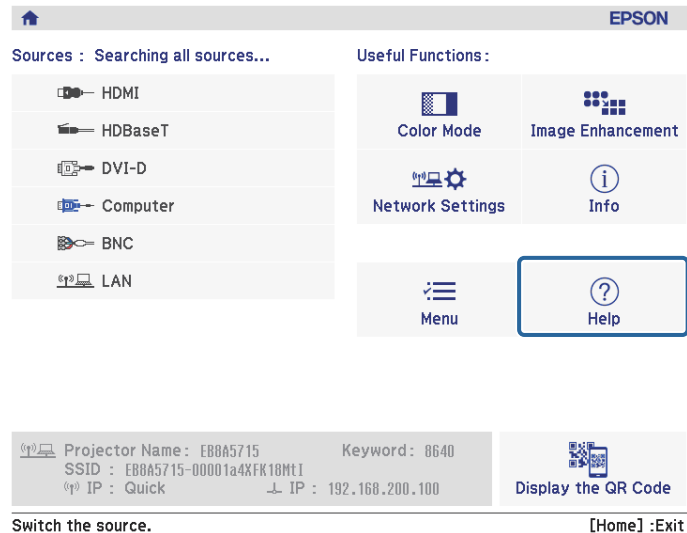

The Help screen is displayed.

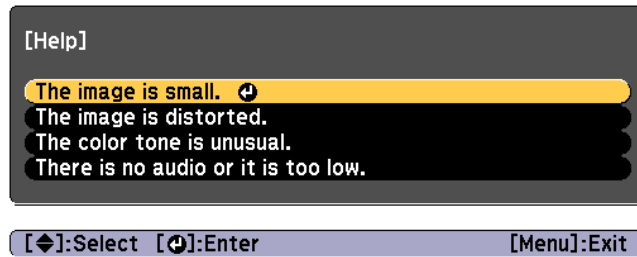

3 Select a menu item.

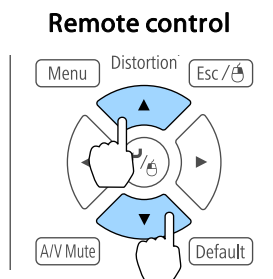

4 Confirm the selection.

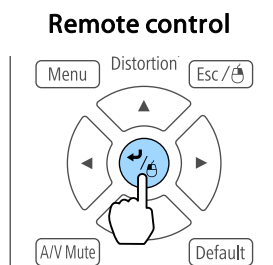

See the following if the Help function does not provide a solution to the problem.

👉 "Reading the Indicators" [p.164](#)

Questions and solutions are displayed as shown on the screen below.

Press the [Menu] button to exit Help.

The image is small.

- ❓ Is zoom set to minimum?
· Press the [Zoom] button to change the size of the image.
- ❓ Is the projector too close to the screen?
· Move the projector away from the screen.

[Esc] :Return





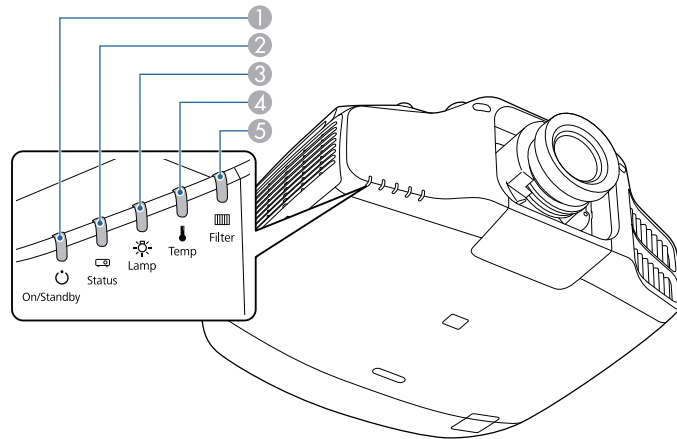





[Menu]:Exit





















The projector is provided with the following five indicators that indicate the operating status of the projector.



- ① Power indicator
Indicates the projector's status.
- ② Status indicator
Indicates the projector's status.
- ③ Lamp indicator
Indicates the projection lamps status.
- ④ Temp indicator
Indicates the internal temperature status. This is normally turned off.
- ⑤ Filter indicator
Indicates the air filter status. This is normally turned off.





























The following indicator status are used during regular operation.















Indicator					Projector's Status	Explanation
Power	Status	Lamp	Temp	Filter		
 Blue - On	 Off	 Off	 Off	 Off	Standby condition	Power is being supplied to the projector. In this status, you can start projecting by pressing the [ⓘ] button on the remote control or control panel. (Sometimes, when the power cord is unplugged, the power indicator remains lit for a short period, but this is not a fault.)
 Blue - On	 Blue - Flashing	 Status varies	 Off	 Off	Warm-up status	This is the status immediately after turning on the projector. Warm-up takes approximately 30 seconds after the lamp turns on. The [⏸] button is disabled during warm-up.















Indicator					Projector's Status	Explanation
Power	Status	Lamp	Temp	Filter		
 Blue - On	 Blue - On	 Status varies	 Off	 Off	Projecting	The projector is projecting.
 Blue - On	 Blue - Flashing	 Off	 Off	 Off	Cool down status	This is the status immediately after turning off the power. In this status, all buttons are disabled.
 Blue - Flashing	 Off	 Off	 Off	 Off	Preparing Network monitoring	Preparing to monitor and control this projector over a network. During network monitoring preparation, all button operations are disabled.
 Blue - On	 Blue - On	 Blue - Flashing	 Off	 Off	A/V Mute activated	A/V Mute is active.











When an error has occurred in the projector, the error status is indicated by the indicator's color and combination of flashing or lit.

Refer to the following table to see what the indicators mean and how to remedy problems that they indicate.

Indicator					Cause	Remedy or Status
Power	Status	Lamp	Temp	Filter		
 Off	 Blue - Flashing	 Orange - Flashing	 Off	 Off	Internal Error	Stop using the projector, remove the power plug from the electrical outlet, and contact your local dealer or the nearest address provided in the Epson Projector Contact List.  Epson Projector Contact List
 Off	 Blue - Flashing	 Off	 Orange - Flashing	 Off	Fan Error Sensor Error	Stop using the projector, remove the power plug from the electrical outlet, and contact your local dealer or the nearest address provided in the Epson Projector Contact List.  Epson Projector Contact List
 Off	 Blue - Flashing	 Off	 Orange - On	 Off	High Temp Error (Overheating)	<p>The lamp turns off automatically and projection stops. Wait for about five minutes. After about five minutes the projector switches to standby mode, so check the following two points.</p> <ul style="list-style-type: none"> • Check that the air filter and air exhaust vents are clear, and that the projector is not positioned against a wall. • If the air filter are clogged, remove the power cord from the electrical outlet, and then clean or replace them. <ul style="list-style-type: none">  "Cleaning the Air Filter" p.189  "Replacing the Air Filter" p.195 <p>If the error continues after checking the points above, stop using the projector, remove the power plug from the electrical outlet, and contact your local dealer or the nearest address provided in the Epson Projector Contact List.  Epson Projector Contact List</p> <p>When using at an altitude of more than 1,500 m, set High Altitude Mode to On.  Extended - Operation - High Altitude Mode p.140</p>
 Off	 Blue - Flashing	 Orange - On	 Off	 Off	Lamp Error Lamp Failure	<p>Check the following two points.</p> <ul style="list-style-type: none"> • Remove the lamps and check if they are cracked. <ul style="list-style-type: none">  "Replacing the Lamp" p.192 • Clean the air filter. <ul style="list-style-type: none">  "Cleaning the Air Filter" p.189

Indicator					Cause	Remedy or Status
Power	Status	Lamp	Temp	Filter		
						<p>If the lamp is not cracked: Reinstall the lamp and turn on the power.</p> <p>If the error continues: Replace the lamp with a new one and then turn on the power.</p> <p>If the error continues: Stop using the projector, remove the power plug from the electrical outlet, and contact your local dealer or the nearest address provided in the Epson Projector Contact List.</p> <p>☛ Epson Projector Contact List</p> <p>If the lamp is cracked: Contact your local dealer or the nearest address provided in the Epson Projector Contact List. (Images cannot be projected until the lamp is replaced.)</p> <p>☛ Epson Projector Contact List</p> <p>When using at an altitude of 1500 m or more, set High Altitude Mode to On.</p> <p>☛ Extended - Operation - High Altitude Mode p.140</p>
 Off	 Blue - Flashing	 Off	 Off	 Orange - On	Filter Airflow Error	<p>Check the following two points.</p> <ul style="list-style-type: none"> • Check that the air filter and air exhaust vents are clear, and that the projector is not positioned against a wall. • If the air filter is clogged, turn off the power, remove the power cord from the electrical outlet, and then clean or replace them. <p>☛ "Cleaning the Air Filter" p.189</p> <p>☛ "Replacing the Air Filter" p.195</p> <p>After checking, connect the power cord to the electrical outlet.</p> <p>If the error continues after checking the points above, stop using the projector, remove the power plug from the electrical outlet, and contact your local dealer or the nearest address provided in the Epson Projector Contact List.</p> <p>☛ Epson Projector Contact List</p>
 Off	 Blue - Flashing	 Orange - Flashing	 Orange - Flashing	 Off	Auto Iris Error	<p>Stop using the projector, remove the power plug from the electrical outlet, and contact your local dealer or the nearest address provided in the Epson Projector Contact List.</p> <p>☛ Epson Projector Contact List</p>
 Off	 Blue - Flashing	 Orange - On	 Orange - On	 Off	Power Err. (Ballast) Lens Shift Error	<p>Stop using the projector, remove the power plug from the electrical outlet, and contact your local dealer or the nearest address provided in the Epson Projector Contact List.</p> <p>☛ Epson Projector Contact List</p>

Indicator					Cause	Remedy or Status
Power	Status	Lamp	Temp	Filter		
 Blue - Flashing	 Status varies	 Status varies	 Orange - Flashing	 Status varies	High Temp Warning	This is not an error. However, if the temperature rises too high again, projection stops automatically. Check the following two points. <ul style="list-style-type: none"> • Check that the air filter and air exhaust vents are clear, and that the projector is not positioned against a wall. • If the air filter is clogged, turn off the power, remove the power cord from the electrical outlet, and then clean or replace them. <ul style="list-style-type: none"> ☛ "Cleaning the Air Filter" p.189 ☛ "Replacing the Air Filter" p.195
 Blue - Flashing	 Status varies	 Orange - Flashing	 Status varies	 Status varies	Replace Lamp	Replace it with a new lamp. <ul style="list-style-type: none"> ☛ "Replacing the Lamp" p.192 If you continue to use the lamp after the replacement period has passed, the possibility that the lamp may explode increases. Replace it with a new lamp as soon as possible.
 Blue - On	 Status varies	 Orange - Flashing	 Status varies	 Status varies	Installation position warning (non-support position, installation angle)	A message is displayed, and projection stops automatically after about five minutes. Check the installation angle of the projector. <ul style="list-style-type: none"> • Check the guaranteed operating range. <ul style="list-style-type: none"> ☛ "Warning and Cautions on Installation" p.3 • Check if Direction in the Configuration menu is set correctly. <ul style="list-style-type: none"> ☛ "Setting the direction" p.28

Indicator					Cause	Remedy or Status
Power	Status	Lamp	Temp	Filter		
 Blue - Flashing	 Status varies	 Status varies	 Status varies	 Orange - On	Low Air Flow	<p>This is not an error. However, projection stops automatically if the airflow falls any further. "The air filter is clogged. Clean or replace the air filter." is displayed. Check the following points.</p> <ul style="list-style-type: none"> • Check that the air filter and air exhaust vents are clear, and that the projector is not positioned against a wall. • If the air filter is clogged, turn off the power, remove the power cord from the electrical outlet, and then clean or replace them. <ul style="list-style-type: none"> ☛ "Cleaning the Air Filter" p.189 ☛ "Replacing the Air Filter" p.195 <p>If the error continues after checking the points above, stop using the projector, remove the power plug from the electrical outlet, and contact your local dealer or the nearest address provided in the Epson Projector Contact List.</p> <p>☛ Epson Projector Contact List</p>
 Status varies	 Status varies	 Status varies	 Status varies	 Orange - Flashing	Air Filter Notice	<p>"Time to clean the air filter. Clean or replace the air filter." is displayed.</p> <p>Turn off the projector's power, unplug the power cord from the electrical outlet, and then clean the air filter.</p> <p>☛ "Cleaning the Air Filter" p.189</p> <p>The indicators or messages regarding air filter notice are displayed only when Air Filter Notice is set to On in the Configuration menu.</p> <p>☛ Extended - Display - Air Filter Notice p.140</p>



- See the following if the projector is not operating properly, even though the indicators are all showing normal.
 - ☛ "Problem Solving" [p.177](#)
- If the indicators are in a state not shown in this table, stop using the projector, remove the power plug from the electrical outlet, and contact your local dealer or the nearest address provided in the Epson Projector Contact List.
 - ☛ [Epson Projector Contact List](#)

You can display the operating status of the projector on the projected image. You can check the detailed status of the projector by using button operations.

1 Press the [i] button while projecting.

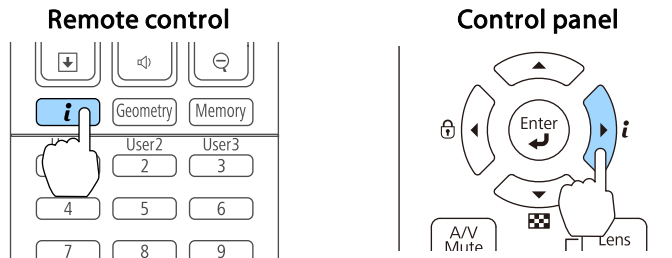

2 Select **Status Information**, and then press the [↵] button.

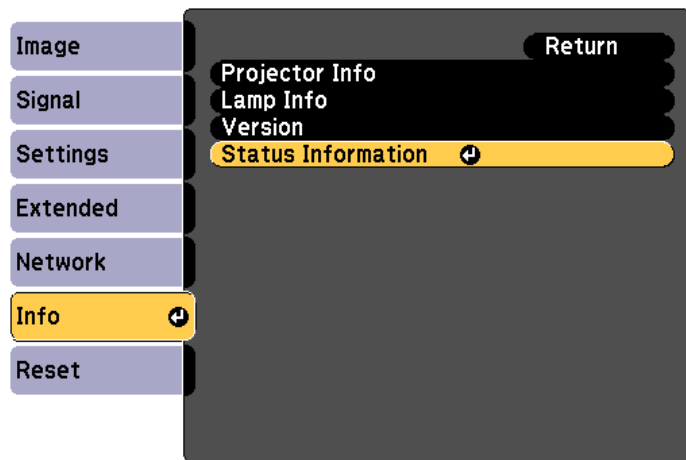

[Esc]:Return [↵]:Select [↵]:Enter [Menu]:Exit



You can also operate from the Configuration menu.

☞ **Info - Status Information** p.152

3 Use the [◀][▶] buttons or the [▲][▼] buttons to select a category.

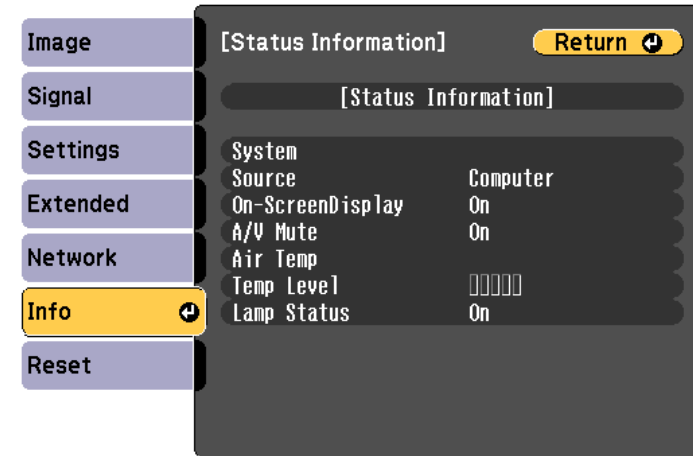

[Esc]/[↵]:Return [◀▶]:Select [Menu]:Exit

Each display category contains the following information.

- Status Information : Operating status of the projector
- Source : Input signal information
- Signal Information : Input digital signal information
- Network Wired : Wired LAN settings
- Network Wireless : Wireless LAN settings
- Maintenance : Operating time for the projector and lamps
- Version : Projector's firmware version

Explanations of the Display Content

Category	Item	Status Display	Explanation
Status Information	System	Displays the projector's status. See the following for more information on how to remedy the errors and warnings. ☛ "Reading the Indicators" p.164	
		OK	The projector is in normal status.
		Warm-Up	The projector is warming up.
		Standby	The projector is in standby status.
		Cool Down	The projector is in cool down status.
		Temp Error	A high temp error has occurred.
		Fan Error	A fan error has occurred.
		Sensor Error	A sensor error has occurred.
		Lamp Error	A lamp error has occurred.
		Lamp Failure	A lamp failure has occurred.
		Power Error	A power error (Ballast) has occurred.
		Internal Error	An internal error has occurred.
		Auto Iris Error	An auto iris error has occurred.
		Airflow Error	A filter airflow error has occurred.
		Temp Warning	A high temp warning has occurred.
		Internal Warning	A warning about the internal system has occurred.
		Airflow Decline	A low air flow error has occurred.
		Lamp Warning	A lamp warning has occurred. Perform the same remedies as when the lamp error has occurred.
		Power Warning	A power warning (Ballast) has occurred.
		Direction Warning	The usage angle is out of range. Set it at the correct angle.
Lamp Replacement	A lamp replacement recommendation has occurred.		
Clean Filter	An air filter notice has occurred.		

Category	Item	Status Display	Explanation
Status Information	Source	HDMI	Displays the source name for the connected equipment currently being projected.
		HDBaseT	
		DVI-D	
		Computer	
		BNC	
		LAN	
	On-Screen Display	On	Displays the settings for the On-Screen Display . When set to Off , the menus or messages are not displayed on the projected images.
		Off	
	A/V Mute	On	Displays the operating status of A/V mute.
		Off	
	Air Temp	-	Displays the usage environment temperature.
	Temp Level	-	
Lamp Status	On	Displays the operating status of the lamp.	
	Off		
Source	Source	HDMI	Displays the source name for the connected equipment currently being projected.
		HDBaseT	
		DVI-D	
		Computer	
		BNC	
		LAN	
	Resolution	-	Displays the resolution of the current input signal. No Signal: No signals are being input. Not Supported: The projector does not support the current input signal.
	Video Signal	-	Displays the current input video signal.

Category	Item	Status Display	Explanation
Source	Color Space	RGB	Displays the color space of the current input signal.
		YCbCr	
		YPbPr	
	H-Frequency	-	Displays the horizontal frequency of the current input signal.
	V-Frequency	-	Displays the vertical frequency of the current input signal.
	Sync Polarity	H:Posi / V:Posi	Displays the Sync polarity.
		H:Posi / V:Nega	
		H:Nega / V:Posi	
		H:Nega / V:Nega	
	Sync Mode	Composite Sync	Displays the sync type.
		Separate Sync	
		Sync On Green	
	Detected Mode	-	Displays the discriminant resolution of the current input signal.
	Video Level	Auto (Normal)	Displays the video level of the projector.
Auto (Expanded)			
Normal			
Expanded			



Items displayed for source vary depending on the model being used and the image signal and source being projected.

Category	Item	Status Display	Explanation
Signal Information	5V Detection	Detected	Displays the detection results of 5V signals.
		Not Detect	
	TMDS Clock	-	Displays the TMDS frequency of the current input signal.
	TMDS H-Frequency	-	Displays the horizontal frequency of the current input signal.
	TMDS V-Frequency	-	Displays the vertical frequency of the current input signal.
	DetChg 5CFHMP123	-	Displays the factors of signal changes.
	Stable Time	-	Displays the operating time since the input source is determined.
	HDCP Status	Non-HDCP	Displays the HDCP status.
		Passed	
		Failed	
	HDCP Ver	-	Displays the HDCP version.
	AVI Info VIC	-	Displays the VIC information (AVI) of the current input signal.
	AVI InfoChecksum	OK	Displays the checksum result for AVI.
		NG	
	Signal Mode	HDMI	Displays the signal mode.
		DVI	
	Pixel Encoding	RGB	Displays the color space information (AVI) of the current input signal.
YUV4:4:4			
YUV4:2:2			
YUV4:2:0			
HDBaseT Level	-	You can display the image signal information from the HDBaseT port.	



Items displayed for Signal Information vary depending on the model being used and the image signal and source being projected.











Category	Item	Status Display	Explanation
Network Wired	Projector Name	-	Displays the projector name used to identify the projector when connected to a network.
	Connection Mode	HDBaseT	Displays the connection path for LAN.
		LAN	
	DHCP	On	Displays the HDCP settings.
		Off	
	IP Display	On	Displays the IP address display settings.
		Off	
IP Address	-	Displays the IP address.	
MAC Address	-	Displays the MAC address.	
Network Wireless	Projector Name	-	Displays the projector name used to identify the projector when connected to a network.
	Connection Mode	Quick	Displays the connection mode to use when connecting the projector and a computer over a wireless LAN.
		Advanced	
	SSID Display	On	Displays the SSID display settings.
		Off	
	IP Display	On	Displays the IP address display settings.
		Off	
	SSID	-	Displays the SSID.
	IP Address	-	Displays the IP address.
	DHCP	On	Displays the HDCP settings.
		Off	
	MAC Address	-	Displays the MAC address.
	Security	No	Displays the security settings.
WPA2-PSK			
WPA/WPA2-PSK			
Antenna Level	LEVEL 0-5	Displays the reception status for Wi-Fi.	



Category	Item	Status Display	Explanation
Maintenance	Operation Time	-	Displays the total operation time of the projector.
	Lamp Op.Time	-	Displays the cumulative lamp operating time. (Normal)
	Lamp Op.Time PR	-	Displays the cumulative lamp operating time. (Portrait Mode)
Version	Serial No.	-	Displays the projector's serial number.
	Main	-	Displays the projector's firmware version information.
	Video2	-	
	Sub	-	
	Sub2	-	
	HDBaseT	-	

If any of the following problems occur and the indicators do not offer a solution, refer to the pages given for each problem.



Problems relating to images





<ul style="list-style-type: none"> • No images appear Projection does not start, the projection area is completely black, or the projection area is completely blue. 	 p.178
<ul style="list-style-type: none"> • Moving images are not displayed Videos played back on a computer are black or no image is projected, or the video is not played back on the computer. 	 p.178
<ul style="list-style-type: none"> • Projection stops automatically 	 p.179
<ul style="list-style-type: none"> • The message "Not supported" is displayed 	 p.179
<ul style="list-style-type: none"> • The message "No Signal" is displayed 	 p.179
<ul style="list-style-type: none"> • Images are fuzzy, out of focus, or distorted 	 p.180
<ul style="list-style-type: none"> • Interference or distortion appear in images 	 p.180
<ul style="list-style-type: none"> • The image is truncated (large) or small, the aspect ratio is not suitable, or the image has been reversed Only part of the image is displayed, the height and width ratios of the image are not correct, or the image may appear reversed from top to bottom or left to right. 	 p.181
<ul style="list-style-type: none"> • Image colors are not right The whole image appears purplish or greenish, images are black & white, or colors appear dull. 	 p.182
<ul style="list-style-type: none"> • Images appear dark 	 p.182

Problems when projection starts

<ul style="list-style-type: none"> • The projector does not turn on 	 p.183
---	---

Other problems

<ul style="list-style-type: none"> • No sound can be heard or the sound is faint 	 p.184
<ul style="list-style-type: none"> • The remote control does not work 	 p.184

<ul style="list-style-type: none"> • Nothing appears on the external monitor 	 p.185
<ul style="list-style-type: none"> • I want to change the language for messages and menus 	 p.186
<ul style="list-style-type: none"> • Email is not received even if a problem occurs in the projector 	 p.186
<ul style="list-style-type: none"> • "The battery that saves your clock settings is running low." is displayed 	 p.186

Problems Relating to Images

No images appear

Check	Remedy
Did you press the [ⓘ] button on the remote control or control panel?	Press the [ⓘ] button to turn on the power.
Are the indicators switched off?	The power cord is not connected correctly or power is not being supplied. Connect the projector's power cord correctly. Check that your electrical outlet or power source is functioning correctly.
Is A/V Mute active?	Press the [A/V Mute] button to release A/V Mute. ☛ "Hiding the Image and Sound Temporarily (A/V Mute)" p.117
Are the Configuration menu settings correct?	Reset all of the settings. ☛ Reset - Reset All Config p.153
Is the image to be projected completely black? (Only when projecting computer images)	Some input images, such as screen savers, may be completely black.
Is Windows Media Center displayed in full screen? (Only during network connection)	When Windows Media Center is displayed at full screen, you cannot project using a network connection. Reduce the screen size.
Is an application using the Windows DirectX function displayed? (Only during network connection)	Applications using the Windows DirectX function may not display images correctly.

Moving images are not displayed

Check	Remedy
Is the computer's image signal being output to the LCD and the monitor? (Only when projecting images from a laptop computer or a computer with a built-in LCD screen)	Change the image signal from the computer to external output only. Check your computer's documentation, or contact the computer's manufacturer.
Are the contents of the moving image you are trying to project copyright protected?	The projector may not be able to project copyright protected moving images that are being played back on a computer. For more details, see the user's guide supplied with the player.

Projection stops automatically

Check	Remedy
Is Sleep Mode set to On ?	Press the [⏻] button to turn on the power. If you do not want to use Sleep Mode, change the setting to Off . ☛ Extended - Operation - Sleep Mode p.140

"Not supported" is displayed

Check	Remedy
Do the image signal resolution and the refresh rate correspond to the mode? (Only when projecting computer images)	Refer to the computer's documentation for how to change the image signal resolution and the refresh rate output from the computer. ☛ "Supported Monitor Displays" p.237

"No Signal" is displayed

Check	Remedy
Are the cables connected correctly?	Check that all the cables required for projection are securely connected. Check that no cables are disconnected and that there are no poor contacts in the cables.
Is the correct port selected?	Change the image by pressing the [Search] button. ☛ "Automatically Detecting Input Signals and Changing the Projected Image (Source Search)" p.59
Is the power for the computer or video source turned on?	Turn the power on for the equipment.
Are the image signals being output to the projector? (Only when projecting images from a laptop computer or a computer with a built-in LCD screen)	If the image signals are only being output to the computer's LCD monitor or to the accessory monitor, you need to change the output to an external destination as well as the computer's own monitor. For some computer models, when the image signals are output externally, they no longer appear on the LCD monitor or accessory monitor. If the connection is made while the power of the projector or computer is already turned on, the Fn key (Function key) that changes the computer's image signal to external output may not work. Turn the power for the computer and the projector off and then back on again. ☛ Computer's documentation

Images are fuzzy, out of focus, or distorted

Check	Remedy
Is the focus adjusted correctly?	Make sure that at least 20 minutes has passed after the projection starts, and press the [Focus] button on the remote control to adjust the focus. ☛ "Correcting the Focus" p.37
Is the projector at the correct distance?	Is it projecting outside of the recommended projection distance range? Setup within the recommended range. ☛ "Screen Size and Projection Distance" p.217
Has condensation formed on the lens?	If the projector is suddenly taken from a cold environment to a warm environment, or if sudden ambient temperature changes occur, condensation may form on the surface of the lens, and this may cause the images to appear fuzzy. Set the projector up in the room about one hour before it is used. If condensation forms on the lens, turn the projector off and wait for the condensation to disappear.

Interference or distortion appear in images

Check	Remedy
Are the cables connected correctly?	Check that all the cables required for projection are securely connected. ☛ "Connecting Equipment" p.46
Is an extension cable being used?	If an extension cable is used, electrical interference may affect the signals. Use the cables supplied with the projector to check if the cables you are using may be causing the problem.
Is the correct resolution selected? (Only when projecting computer images)	Set the computer so that the signals being output are compatible with the projector. ☛ "Supported Monitor Displays" p.237 ☛ Computer's documentation
Are the Sync and Tracking settings adjusted correctly? (Only when projecting computer images)	Press the [Auto] button on the Remote Control or the [↵] button on the Control panel to perform automatic adjustment. If the images are not adjusted correctly even after performing automatic adjustment, you can also make adjustments from the Configuration menu. ☛ Signal - Tracking, Sync. p.137
Is the Resolution set to anything other than Auto ? (Only when projecting on a split screen)	The image may be collapsed if the Resolution on the Configuration menu and the resolution of the projected image are not the same. If the image is collapsed, set the Resolution to Auto . ☛ Signal - Resolution p.137

The image is truncated (large) or small, the aspect is not suitable, or the image has been reversed

Check	Remedy
Have the Screen been set correctly?	Make the appropriate Screen for the screen being used. ☛ "Screen Settings" p.30
Is the aspect adjusted correctly?	Press the [Aspect] button to select an aspect suitable for the input source. ☛ "Changing the Aspect Ratio of the Projected Image " p.87
Is a wide panel computer image being projected? (Only when projecting computer images)	Change the setting according to the signal for the connected equipment. ☛ Signal - Resolution p.137
Is the image still being enlarged by E-Zoom?	Press the [Esc] button on the remote control to cancel E-Zoom. ☛ "Enlarging Part of the Image (E-Zoom)" p.118
Is Scale turned on?	Set Scale to Off on the configuration menu. ☛ Signal - Scale p.137
Is the display range restricted by Blanking ?	Appropriately set Blanking in the configuration menu. ☛ Signal - Blanking p.137
Is the image position adjusted correctly?	(Only when projecting analog RGB signals input from the Computer port) Press the [Auto] button on the remote control or the [] button on the control panel to adjust the position. You can also adjust the position from the Configuration menu. ☛ Signal - Position p.137
Is the computer set for dual display? (Only when projecting computer images)	If dual display is activated in the Display Properties of the computer's Control Panel, only about half of the image on the computer screen is projected. To display the entire image on the computer screen, turn off the dual display setting. ☛ Computer video driver documentation
Is the correct resolution selected? (Only when projecting computer images)	Set the computer so that the signals being output are compatible with the projector. ☛ "Supported Monitor Displays" p.237 ☛ Computer's documentation
Is the image direction correct?	Make the correct settings in Projection from the Configuration menu. ☛ "Installation Settings" p.28

Image colors are not right

Check	Remedy
Do the input signal settings match the signals from the connected device?	Change the setting according to the signal for the connected equipment. ☛ Signal - Advanced - Input Signal p.137
Is the image brightness adjusted correctly?	Adjust the Brightness setting from the Configuration menu. ☛ Image - Brightness p.135
Are the cables connected correctly?	Check that all the cables required for projection are securely connected. Check that no cables are disconnected and that there are no poor contacts in the cables. ☛ "Connecting Equipment" p.46
Is the <u>Contrast</u> adjusted correctly?	Adjust the Contrast setting from the Configuration menu. ☛ Image - Contrast p.135
Is the color adjustment set correctly?	Adjust the Gamma or RGBCMY setting from the Configuration menu. ☛ Image - Advanced p.135 ☛ "Adjusting the Image" p.90
Are the color saturation and tint adjusted correctly?	Adjust the Color Saturation and Tint settings from the Configuration menu. ☛ Image - Color Saturation, Tint p.135

Images appear dark

Check	Remedy
Is the image brightness set correctly?	Check the Brightness and Power Consumption settings from the Configuration menu. ☛ Image - Brightness p.135 ☛ Settings - Power Consumption p.138
Is the <u>Contrast</u> adjusted correctly?	Adjust the Contrast setting from the Configuration menu. ☛ Image - Contrast p.135
Is it time to replace the lamp?	When the lamp is nearly ready for replacement, the images become darker and the color quality becomes poorer. When this happens, replace the lamp with a new lamp. ☛ "Replacing the Lamp" p.192
Is only one projector being used?	Check if the following item is set to dark. ☛ Extended - Multi-Projection - Brightness Level p.140

Problems when Projection Starts

The projector does not turn on

Check	Remedy
Did you press the [ⓘ] button on the remote control or control panel?	Press the [ⓘ] button to turn on the power.
Are the indicators switched off?	The power cord is not connected correctly or power is not being supplied. Disconnect and then reconnect the power cord. Check that your electrical outlet or power source is functioning correctly.
Do the indicators turn on and off when the power cord is touched?	There is probably a poor contact in the power cable, or the power cable may be defective. Reinsert the power cable. If this does not solve the problem, stop using the projector, disconnect the power cable from the electrical outlet, and contact your local dealer or the nearest address provided in the Epson Projector Contact List. ☛ Epson Projector Contact List
Is the Control Panel Lock set to Full Lock ?	Press the [ⓘ] button on the remote control. If you do not want to use Control Panel Lock , change the setting to Off . ☛ "Control Panel Lock" p.128
Is the correct setting for the remote receiver selected?	Check the Remote Receiver from the Configuration menu. ☛ Settings - Remote Receiver p.138
Was the power cord plugged back in or was the breaker turned on immediately after direct power off?	When the operation to the left is performed when Direct Power On is set to On , the power may not turn back on. Press the [ⓘ] button to turn on the power.
Is the [ID] switch on the remote control set to On?	When the switch is set to On, you can use the remote control to operate only a projector with a matching ID. Set the [ID] switch to Off. ☛ "Setting the remote control ID" p.42
Are the lamp cover and lamps installed correctly?	If the lamp or lamp cover is installed incorrectly, the projector cannot be turned on. Check how it is installed. ☛ "How to replace the lamp" p.192

Other Problems

No sound can be heard or the sound is faint

Check	Remedy
Check that the audio/video cable is securely attached to both the projector and audio source.	Disconnect the cable from the Audio port, and then reconnect the cable.
Is the projector volume set to the minimum?	Adjust the volume so that sound can be heard. ☛ Settings - Volume p.138 ☛ "Adjusting the Volume" p.61
Is the volume for the computer or from the image source set to the minimum?	Adjust the volume so that sound can be heard.
Is A/V Mute active?	Press the [A/V Mute] button to release A/V Mute. ☛ "Hiding the Image and Sound Temporarily (A/V Mute)" p.117
Is the audio cable's specification "No resistance"?	When using a commercially available audio cable, make sure it is labeled "No resistance".
Is it connected with an HDMI cable?	If no audio is output when connecting via an HDMI cable, set the connected equipment to PCM output.
Is the correct audio input selected?	Check the Audio Settings from the configuration menu. ☛ Extended - A/V Settings - Audio Settings p.140

The remote control does not work

Check	Remedy
Is the remote control light-emitting area pointing towards the remote receiver on the projector during operation?	Point the remote control towards the remote receiver. ☛ "Remote control operating range" p.23
Is the remote control too far from the projector?	Check the operating range. ☛ "Remote control operating range" p.23
Is direct sunlight or strong light from fluorescent lamps shining onto the remote receiver?	Set the projector up in a location where strong light does not shine onto the remote receiver.
Is the correct setting for the Remote Receiver selected?	Check the Remote Receiver from the Configuration menu. ☛ Settings - Remote Receiver p.138

Check	Remedy
Are the batteries dead or have the batteries been inserted correctly?	Make sure the batteries are inserted correctly or replace the batteries with new ones if necessary. ☛ "Replacing the remote control batteries" p.22
Are the remote control ID and the projector ID matched?	Make sure the ID for the projector you want to operate and the ID for the remote control match. To operate all projectors by remote control regardless of the ID setting, set the [ID] switch on the remote control to Off. ☛ "ID Settings" p.41
Does Remote Control Type match the remote control that you are using?	Check the Remote Control Type on the configuration menu. ☛ Extended - Operation - Advanced - Remote Control Type p.140
Is the optional remote control cable connected to the projector's Remote port?	When the remote control cable is connected, the projector's remote receiver is disabled. When not using the remote control cable set, disconnect it from the Remote port.
Is Control Communications or Extron XTP set to On ?	The Remote port is disabled. When using the optional remote control cable set, set Control Communications or Extron XTP to Off . ☛ Extended - HDBaseT p.140
Is the remote control button lock set?	When the remote control button lock is set, buttons except for those needed for basic remote control operations are deactivated. Hold down the [] button to cancel the remote control button lock. ☛ "Remote control button lock" p.129



Nothing appears on the external monitor

Check	Remedy
Are images input from a port other than the Computer port or BNC port?	Only RGB signals from the Computer port or the BNC port can be displayed on an external monitor.
Are you projecting a split screen?	Only RGB signals projected on the left screen from the Computer port or the BNC port can be displayed on an external monitor. ☛ "Projecting Two Images Simultaneously (Split Screen) " p.114
Is the projector in standby status?	Check that Standby Mode , A/V Output , and Monitor Out from the Configuration menu are set correctly. ☛ Extended - Standby Mode, A/V Settings p.140

I want to change the language for messages and menus

Check	Remedy
Change the Language setting.	Adjust the Language setting from the Configuration menu.  Extended - Language p.140

Email is not received even if a problem occurs in the projector



Check	Remedy
Is Standby Mode set to Communication On ?	To use the Mail Notification function when the projector is in standby, set Communication On in Standby Mode from the Configuration menu.  Extended - Standby Mode p.140
Did a fatal abnormality occur and the projector come to a sudden stop?	When the projector comes to a sudden stop, email cannot be sent. If the abnormal state continues, contact your local dealer or the nearest address provided in the Epson Projector Contact List.  Epson Projector Contact List
Is power being supplied to the projector?	Check that your electrical outlet or power source is functioning correctly.
Is the Mail Notification function set correctly in the Configuration menu?	An error notification email is sent according to the Notification settings in the Configuration menu. Check if it is set correctly.  "Notification menu" p.150

"The battery that saves your clock settings is running low." is displayed

Check	Remedy
The internal power supply that saves your clock settings is running low.	Contact your local dealer or the nearest address provided in the Epson Projector Contact List.  Epson Projector Contact List

Check the numbers and then apply the following countermeasures. If you cannot resolve the problem, contact your network administrator, or contact your local dealer or the nearest address provided in the Epson Projector Contact List.

 [Epson Projector Contact List](#)

Event ID	Cause	Remedy
0432 0435	Failed to start the network software.	Restart the projector.
0434 0482 0484 0485	Network communication is unstable.	Check the network communication status, and reconnect after waiting for a while.
0433	Cannot play transferred images.	Restart the network software.
0481	Communication was disconnected from the computer.	
0483 04FE	The network software ended unexpectedly.	Check the status of network communications. Restart the projector.
0479 04FF	A system error occurred in the projector.	Restart the projector.
0891	Cannot find an access point with the same SSID.	Set the computer, the access point, and the projector to the same SSID.
0892	The WPA/WPA2 authentication type does not match.	Check that the wireless LAN security settings are correct.
0893	The TKIP/AES encryption types do not match.	 Network - Wireless LAN p.147
0894	Communication was disconnected because the projector connected to an unauthorized access point.	Contact your network administrator for more information.
0898	Failed to acquire DHCP.	Check that the DHCP server is operating correctly. If you are not using DHCP, turn off the DHCP setting.  Network - Wireless LAN p.147 , Wired LAN p.150
0899	Other communication errors	If restarting the projector or network software does not solve the problem, contact your local dealer or the nearest address provided in the Epson Projector Contact List.  Epson Projector Contact List



Maintenance

This chapter provides information on maintenance procedures to ensure the best level of performance from the projector for a long time to come.

You should clean the projector if it becomes dirty or if the quality of projected images starts to deteriorate.



Caution

When cleaning, unplug the power cable from the electric outlet. Otherwise, it could cause an electric shock.

Cleaning the Projector's Surface

Clean the projector's surface by wiping it gently with a soft cloth.

If the projector is particularly dirty, moisten the cloth with water containing a small amount of neutral detergent, and then firmly wring the cloth dry before using it to wipe the projector's surface.

Attention

Do not use volatile substances such as wax, alcohol, or thinner to clean the projector's surface. The quality of the case may change or become discolored.

Cleaning the Lens

Use a commercially available cloth for cleaning glasses to gently wipe the lens.



Warning

Do not use sprays that contain flammable gas to remove dust and lint from the lens. The projector may catch fire due to the high internal temperature of the lamp.

Attention

Do not rub the lens with harsh materials or subject the lens to shocks, as it can easily become damaged.

Cleaning the Air Filter

When the following message is displayed and the filter indicator flashes, clean the air filter and the air intake vent.

"Time to clean the air filter. Clean or replace the air filter."

"The projector is overheating. Make sure nothing is blocking the air vent, and clean or replace the air filter."

"The air filter is clogged. Clean or replace the air filter."

Attention

- If dust collects on the air filter, it can cause the internal temperature of the projector to rise, and this can lead to problems with operation and shorten the optical engine's service life. Clean the air filter immediately when the message is displayed.
- Do not rinse the air filter in water. Do not use detergents or solvents.
- When using a brush for cleaning, use one with long soft bristles, and brush it lightly. If it is brushed too strongly, dust will be ground into the air filter and cannot be removed.

Cleaning the air filter

The air filter can be replaced even when the projector is suspended from a ceiling.



After you turn off the projector's power and the confirmation buzzer beeps, disconnect the power cord.

- 2** Open the air filter cover.
Slide the air filter cover operation knob, and open the air filter cover.

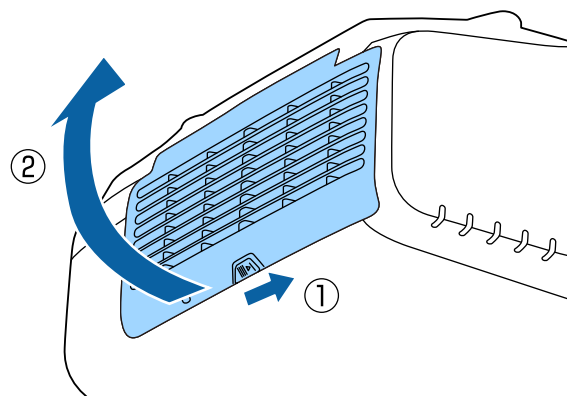

- 3** Remove the air filter.
Grip the tab in the center of the air filter, and pull it straight out.

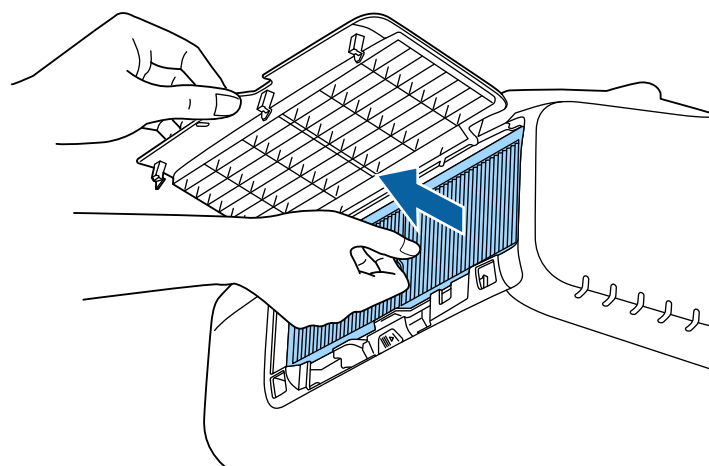

- 4** With the front (the side with tabs) of the air filter facing down, tap the air filter four or five times to shake off the dust.
Turn it over and tap the other side in the same way.

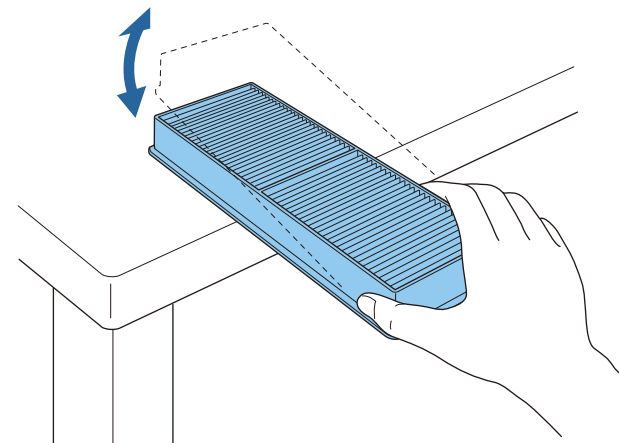

Attention

If the air filter is hit too hard, it may become unusable due to deformities and cracks.

- 5** Remove any dust remaining on the air filter by using a vacuum cleaner from the front side.

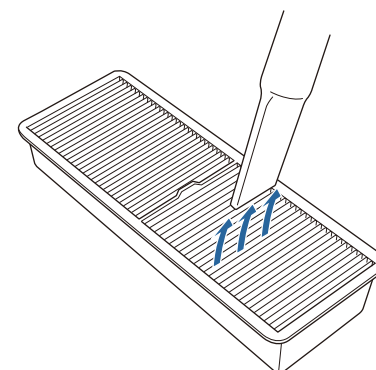

- 6** Replace the air filter.
Press until it clicks into place.

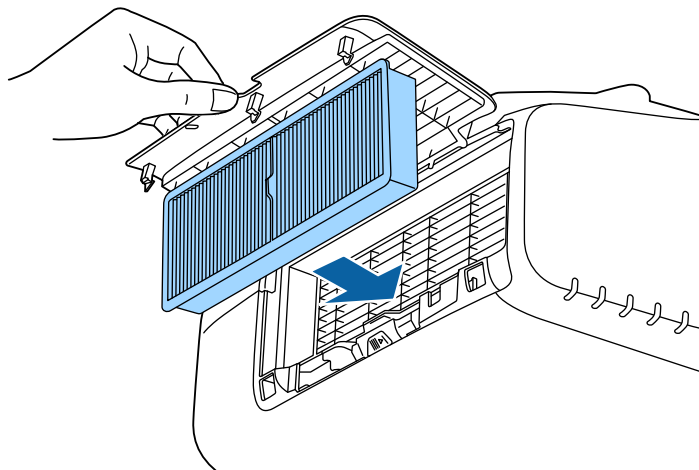

- 7** Close the air filter cover.



- If a message is frequently displayed, even after cleaning, it is time to replace the air filter. Replace it with a new air filter.
 - ☛ "Replacing the Air Filter" [p.195](#)
- The air filter should be cleaned approximately every 15,000 hours. Clean them more often than this if using the projector in a particularly dusty environment.
- The indicators or messages regarding Air Filter Notice are displayed only when **Air Filter Notice** is set to **On** from the Configuration menu.
 - ☛ **Extended - Display - Air Filter Notice** [p.140](#)

This section explains how to replace the lamp and the air filter.

Replacing the Lamp

Lamp replacement period

It is time to replace the lamp when:

- The following message is displayed.
"It is time to replace your lamp. Please contact your Epson projector reseller or visit www.epson.com to purchase."

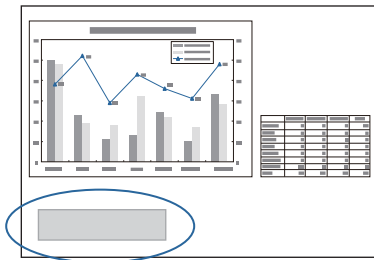

The message is displayed for 30 seconds.

- The power indicator is flashing blue, and the lamp indicator is flashing orange.

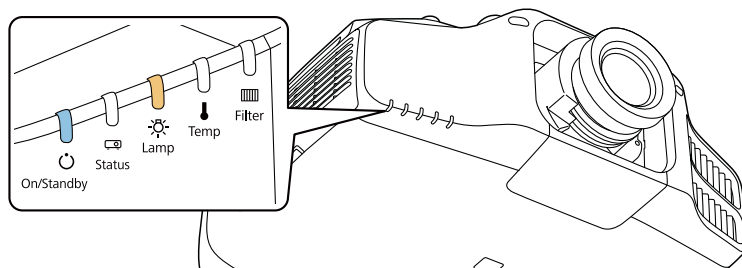

- The projected image gets darker or starts to deteriorate.

Attention

- If you continue to use the lamp after the replacement period has passed, the possibility that the lamp may explode increases. When the lamp replacement message appears, replace the lamp with a new one as soon as possible, even if it is still working.
- Do not repeatedly turn off the power and immediately back on. Turning the power on and off frequently may shorten the lamp's operating life.
- Depending on the characteristics of the lamp and the way it has been used, the lamp may become darker or stop working before the lamp warning message appears. You should always have a spare lamp unit ready in case it is needed.
- We recommend the use of genuine EPSON spare lamps. The use of non-genuine lamps may affect projection quality and safety. Any damage or malfunction caused by the use of non-genuine lamps may not be covered by Epson's warranty.



- We recommend that you clean the air filter whenever you replace the lamp.
 - ☛ "Cleaning the Air Filter" [p.189](#)
- Replace the air filter if it is discolored or if a message appears even after cleaning the air filter.
 - ☛ "Replacing the Air Filter" [p.195](#)

How to replace the lamp

The lamp can be replaced even when the projector is suspended from a ceiling.

Warning

- When replacing the lamp because it has stopped illuminating, there is a possibility that the lamp may be broken. If replacing the lamp of a projector which has been installed on the ceiling, you should always assume that the lamp is cracked, and you should stand to the side of the lamp cover, not underneath it. Remove the lamp cover gently. Be careful when removing the lamp cover as shards of glass may fall out and could cause an injury. If any shards of glass get into your eyes or mouth, contact your local physician immediately.
- Never disassemble or remodel the lamp. If a modified or disassembled lamp is installed in the projector and used, it could cause a fire, electric shock, or an accident.

Caution

Wait until the lamp has cooled down sufficiently before removing the lamp cover. If the lamp is still hot, burns or other injuries may result. It takes about one hour after the power has been turned off for the lamp to be cool enough.

- 1** After you turn off the projector's power and the confirmation buzzer beeps, disconnect the power cord.
- 2** Wait until the lamp has cooled down, then remove the projector's lamp cover.
Loosen the Lamp cover fixing screw with the screwdriver supplied with the new lamp unit or a cross-head screwdriver, and then remove the lamp cover. Because there is a string attached to the lamp cover to prevent it from falling, you can replace the lamp even when the projector is installed on a ceiling without the lamp cover falling down.

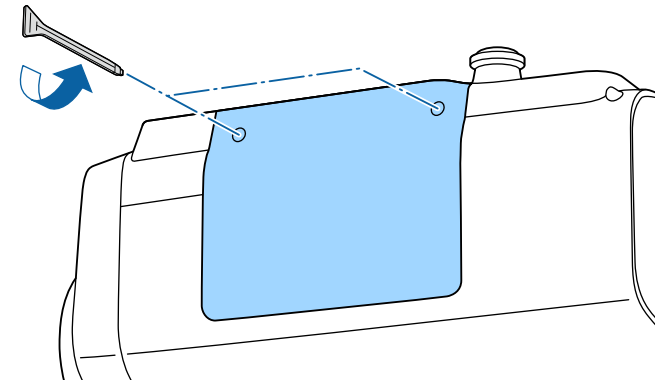

- 3** Loosen the two lamp fixing screws.

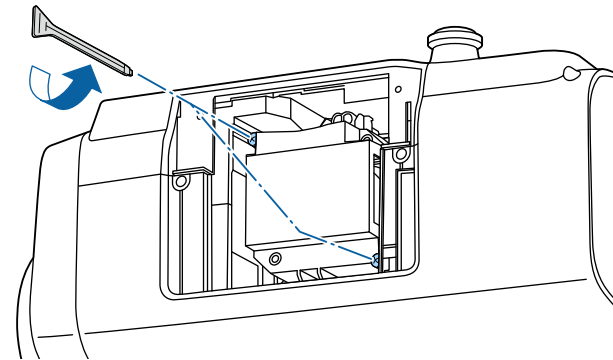

- 4** Take out the old Lamp by pulling the handle.
If the Lamp is cracked, replace it with a new lamp, or contact your local dealer for further advice.

 [Epson Projector Contact List](#)

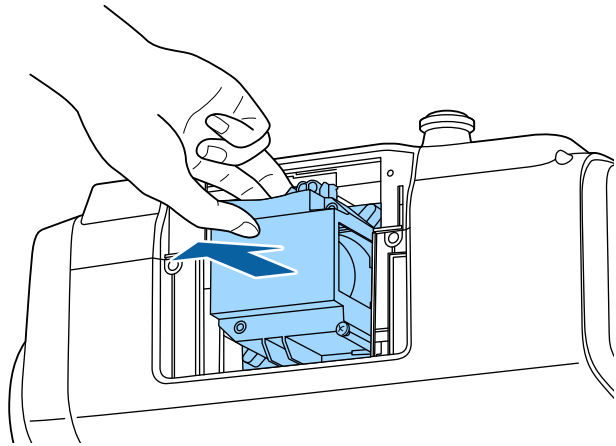

- 5** Install the new lamp.
Insert the lamp along the guide rail in the correct direction so that it fits in place and press it firmly to the back.

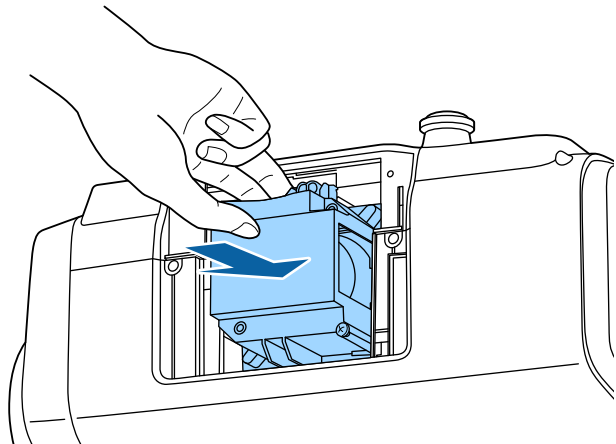

- 6** Tighten the two lamp fixing screws.

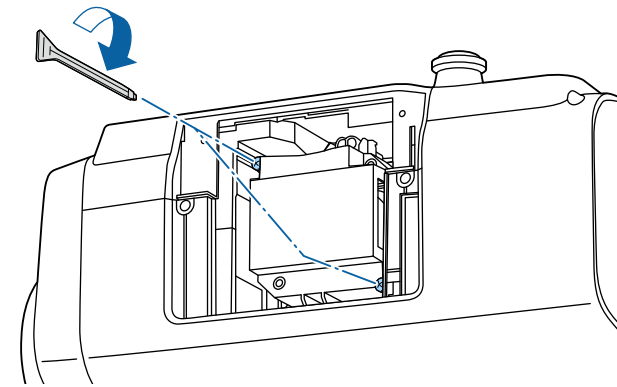

- 7** Replace the lamp cover.

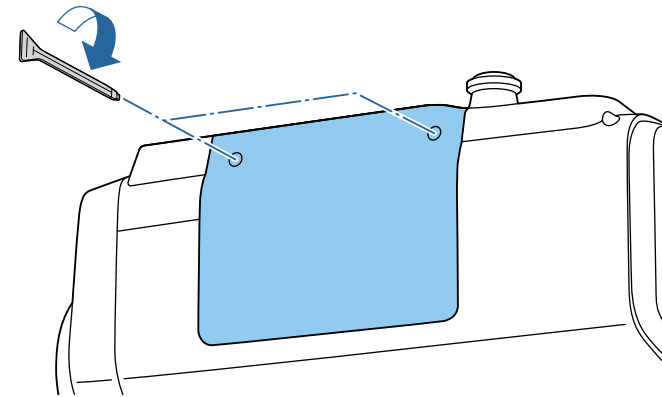

Attention

- Make sure you install the lamp and lamp cover securely. If the lamp cover is removed, the lamps turn off automatically as a safety precaution. If the lamp or the lamp cover is not installed correctly, the lamp will not turn on. Install the lamp cover so that it will fit precisely and not be deformed.
- This product includes a lamp component that contains mercury (Hg). Please consult your local regulations regarding disposal or recycling. Do not dispose of it with normal waste.

Resetting the lamp hours

The projector records how long the lamp is turned on and a message and indicator notify you when it is time to replace the lamp. After replacing the lamp, make sure you reset the **Lamp Hours** from the Configuration menu.

☛ "Reset Menu" [p.153](#)



Only reset the **Lamp Hours** after the lamp has been replaced. Otherwise the lamp replacement period is not indicated correctly.

Replacing the Air Filter

Air filter replacement period

If the message is displayed frequently even though the air filter has been cleaned, replace the air filter.

How to replace the air filter

The air filter can be replaced even when the projector is suspended from a ceiling.

- 1** After you turn off the projector's power and the confirmation buzzer beeps, disconnect the power cord.
- 2** Open the air filter cover.
Slide the air filter cover operation knob, and open the air filter cover.

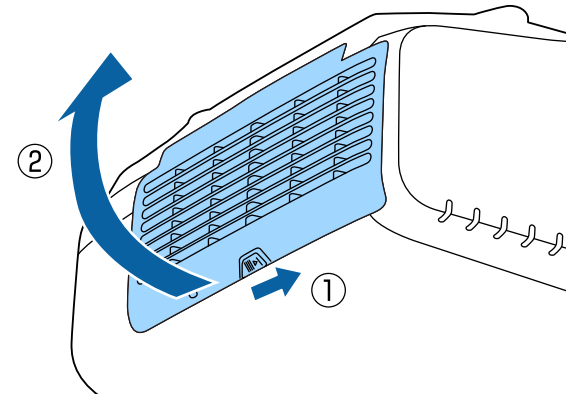

- 3** Remove the air filter.
Grip the tab in the center of the air filter, and pull it straight out.

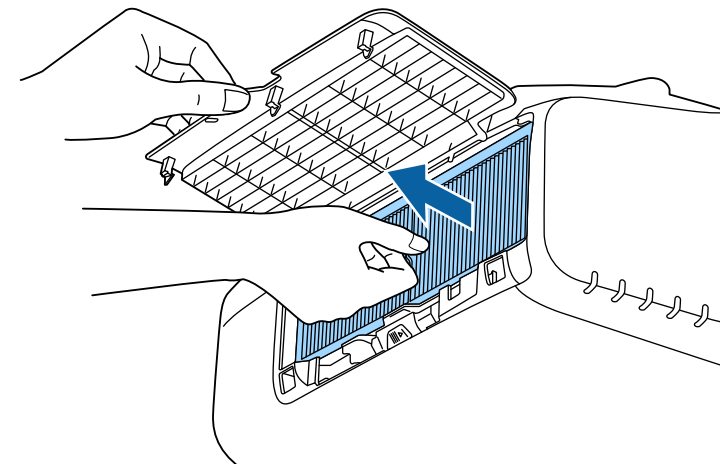

- 4** Install the new air filter.
Press until it clicks into place.

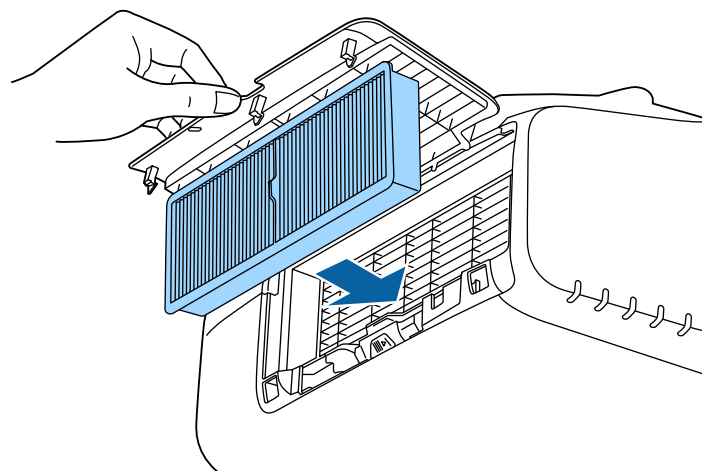

5 Close the air filter cover.



Dispose of used air filters properly in accordance with your local regulations.

Material of the frame part: Polypropylene

Material of the filter part: Polypropylene

Panel Alignment

Adjusts the pixel color shift for the LCD panel. You can adjust the pixels horizontally and vertically by 0.25 pixel within a range of ± 1 pixel.



- Image quality may decline after performing LCD alignment.
- Images for pixels that extend beyond the edge of the projected screen are not displayed.

- 1 Press the [Menu] button while projecting.
- 2 Select **Display** from **Extended**.
- 3 Select **Panel Alignment**, and then press the [\leftarrow] button.

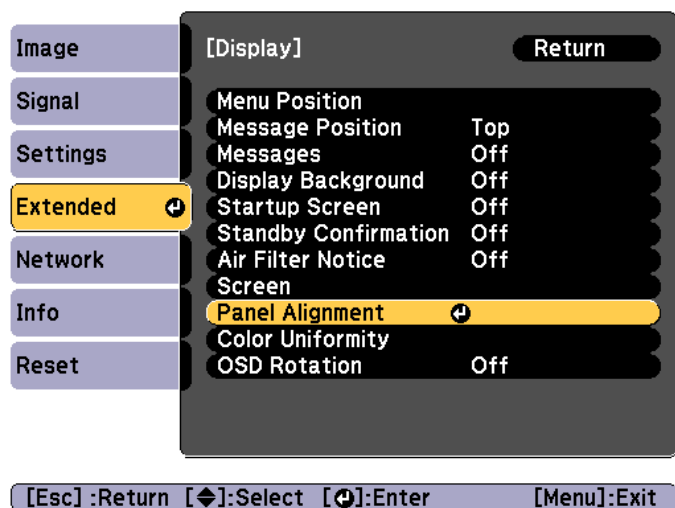

- 4 Enable **Panel Alignment**.

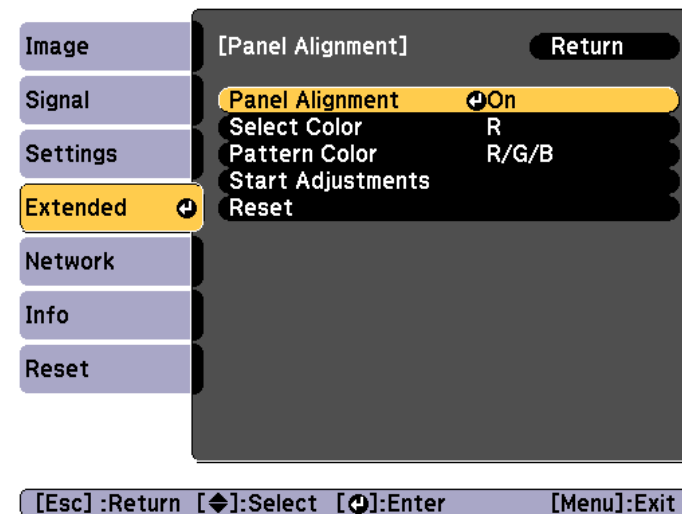

- (1) Select **Panel Alignment**, and then press the [\leftarrow] button.
- (2) Select **On**, and then press the [\leftarrow] button.
- (3) Press the [Esc] button to return to the previous screen.

- 5 Select the color you want to adjust.
 - (1) Select **Select Color**, and then press the [\leftarrow] button.
 - (2) Select **R** (red) or **B** (blue), and then press the [\leftarrow] button.
 - (3) Press the [Esc] button to return to the previous screen.
- 6 Select the grid color displayed when making adjustments from **Pattern Color**.
 - (1) Select **Pattern Color**, and then press the [\leftarrow] button.

- (2) Select a combination of R (red), G (green), and B (blue) for the grid color.
- R/G/B:** Displays a combination all three colors; red, green and blue. The actual color of the grid is white.
- R/G:** This is available when **R** is selected from **Select Color**. Displays a combination of two colors; red and green. The actual color of the grid is yellow.
- G/B:** This is available when **B** is selected from **Select Color**. Displays a combination of two colors; green and blue. The actual color of the grid is cyan.
- (3) Press the [Esc] button to return to the previous screen.

- 7** Select **Start Adjustments**, and then press the [**↵**] button. When the message is displayed, press the [**↵**] button again.

Adjustment starts. All four corners are adjusted in order starting at the top left.



The image may become distorted while adjusting. The image is restored once adjustments are complete.

- 8** Use the [**▲**], [**▼**], [**◀**], and [**▶**] buttons to make adjustments, and then press the [**↵**] button to move to the next adjustment point.
- 9** When you have adjusted all four corners, select **Exit**, and then press the [**↵**] button.

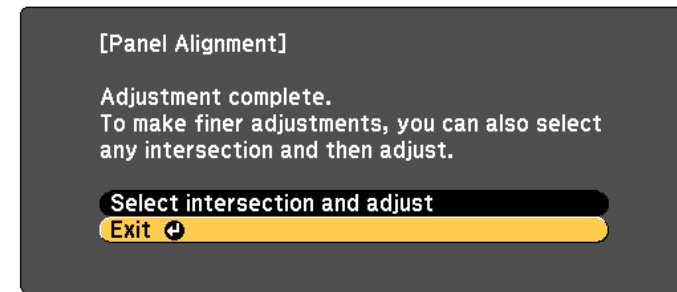

[**◆**]:Select [**⏎**]:Enter [Menu]:Exit

If you feel you still need to make adjustments after correcting all four points, select **Select intersection and adjust** and then continue making adjustments.

Color Uniformity

Adjusts the color tone for the whole screen.



The color tone may not be uniform even after performing color uniformity.

- 1** Press the [Menu] button while projecting.
- 2** Select **Display** from **Extended**.
- 3** Select **Color Uniformity**, and then press the [**↵**] button. The following screen is displayed.

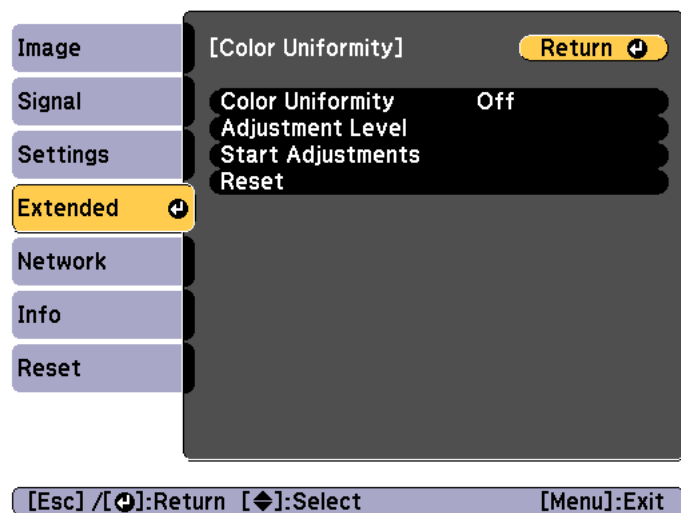

Color Uniformity: Turns color uniformity on or off.

Adjustment Level: There are eight levels from white, through gray, and up to black. You can adjust each level individually.

Start Adjustments: Starts making color uniformity adjustments.

Reset: Resets all adjustments and settings for **Color Uniformity** to their default values.



The image may become distorted while adjusting **Color Uniformity**. The image is restored once adjustments are complete.

- 4 Select **Color Uniformity**, and then press the [↵] button.
- 5 Set to **On**, and then press the [Esc] button.
- 6 Select **Adjustment Level**, and then press the [↵] button.
- 7 Use the [◀][▶] buttons to set the adjustment level.

- 8 Press the [Esc] button to return to the previous screen.
- 9 Select **Start Adjustments**, and then press the [↵] button.
- 10 Select the area you want to adjust, and then press the [↵] button.
Adjust the outer areas first, and then adjust the whole screen.

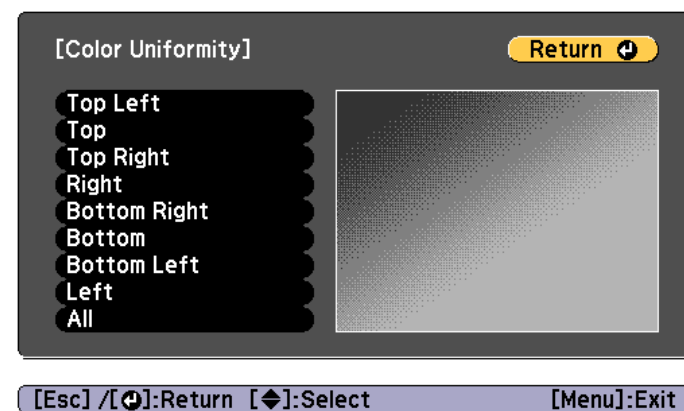

- 11 Use the [▲][▼] buttons to select the color you want to adjust, and then use the [◀][▶] buttons to adjust.
Press the [◀] button to weaken the color tone. Press the [▶] button to strengthen the color tone.

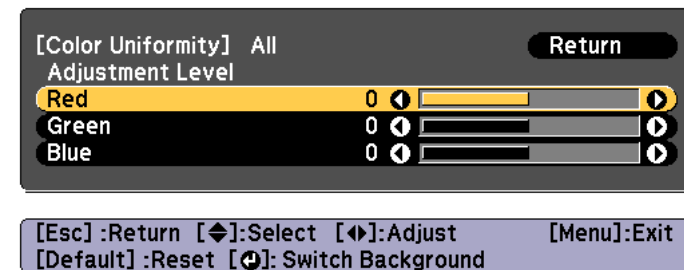

- 12 Return to step 6 and adjust each level.



- 13** To complete the adjustment, press the [Menu] button.



Appendix

About EasyMP Monitor

EasyMP Monitor lets you carry out operations such as checking the status of multiple Epson projectors that are connected to a network at a computer monitor, and controlling the projectors from the computer.

You can download EasyMP Monitor from the following Web site.

<http://www.epson.com>

About Message Broadcasting

Message Broadcasting is plugin software for EasyMP Monitor.

Message Broadcasting can be used to send a message (JPEG file) to project on all Epson projectors or specified projectors connected on the network.

The data can be sent manually, or sent automatically using Timer Settings of EasyMP Monitor.

Download the Message Broadcasting software from the following website.

<http://www.epson.com>

Changing Settings Using a Web Browser (Epson Web Control)

By using a Web browser of a computer or mobile device connected to the projector on a network, you can set functions and control the projector. This function allows you to perform setup and control operations remotely. Also, you can operate a specific projector when using multiple projectors.

Use Internet Explorer 9.0 or later as the Web browser. Use Safari for OS X.



If you set **Standby Mode** to **Communication On**, you can use the Web browser to make settings and perform control even if the projector is in standby mode (when the power is off).

 **Extended - Standby Mode** [p.140](#)

Displaying the Epson Web Control Screen

Use the following procedure to display the Epson Web Control screen.

Make sure your device and projector are ready for the network connection.



If your Web browser is set up to connect via a proxy server, the Epson Web Control screen cannot be displayed. To display Web Control, you need to make settings so that a proxy server is not used for a connection.

- 1** Connect your device to the same network as the connected projector.
The connection method varies depending on the device. See the manual supplied with your device for details. When using a tablet, check the Wi-Fi settings.
- 2** Start the Web browser on your device.
- 3** Connect by entering the address of the connected projector in the URL field of the Web browser.
The Home screen is displayed.

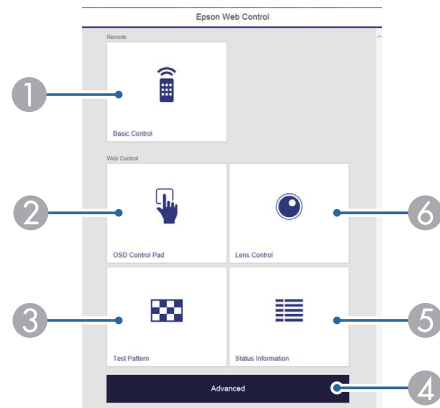

- ① **Basic Control**
 🖱️ "Basic Control Screen" [p.203](#)
- ② **OSD Control Pad**
 🖱️ "OSD Control Pad Screen" [p.204](#)
- ③ **Test Pattern**
 🖱️ "Test Pattern Operation Screen" [p.206](#)
- ④ **Advanced**
 You are moved to the Advanced screen.
- ⑤ **Status Information**
 🖱️ "Status Information Screen" [p.206](#)
- ⑥ **Lens Control**
 🖱️ "Lens Control Screen" [p.204](#)



- When performing the functions from the Home screen, you may be prompted to enter the user name and password. The following two types of user names and passwords are available.
 Remote: The user name is "EPSONREMOTE" and the default password is "guest".
 Web Control: The user name is "EPSONWEB" and the default password is "admin".
- You cannot change the user name. You can change the password in the Network menu from the Configuration menu.
 🖱️ **Network - Basic - Remote Password, Web Control Password** [p.134](#)
- You must enter the user name for Web Control Password even when the password is disabled.

Basic Control Screen

You can perform basic projector operations.

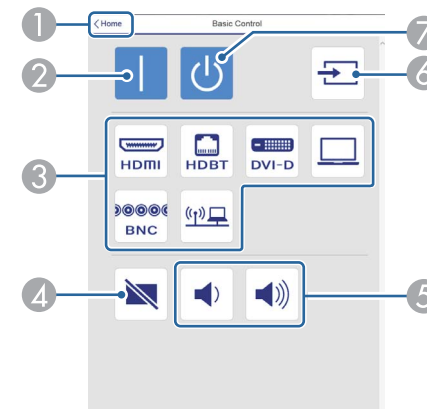

- ① Moves to the Home screen.
- ② Turns the projector on.
- ③ Switches to the target image.

- ④ Turns the video and audio on or off.
- ⑤ You can adjust the volume.
- ⑥ Automatically detects the input signal.
- ⑦ Turns the projector off.

OSD Control Pad Screen

You can operate the Configuration menu of the projector.

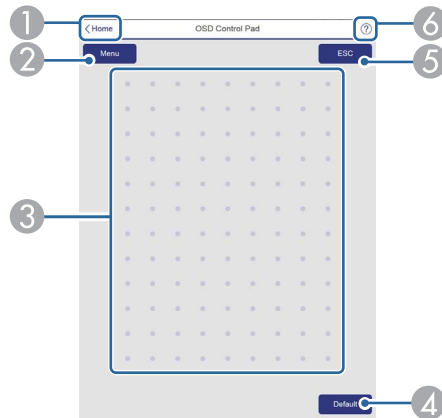

- ① Moves to the Home screen.
- ② Displays and closes the Configuration menu.
- ③ You can operate the Configuration menu using your finger or mouse. Flick to select an item, and tap to confirm the selection.
- ④ Enabled when **Default**: Reset is displayed on the Configuration menu guide. The settings being adjusted are returned to their default values.
- ⑤ Returns to the previous menu level in the Configuration menu.
- ⑥ Displays information on how to use the OSD control pad.



Items in the Configuration menu that cannot be set in Epson Web Control are listed below.

- Settings Menu - User Button
- Extended menu - Display - Message Position
- Extended Menu - User's Logo
- Extended menu - Operation - Advanced - BNC Sync Termination, HDMI DDC Buffer, DVI-D DDC Buffer, Lens Type
- Extended menu - Operation - Lens Calibration
- Extended Menu - Language
- Reset Menu - Reset Lamp Hours

The settings for items on each menu are the same as the projector's Configuration menu.

☞ "Configuration Menu" [p.131](#)

Lens Control Screen

You can operate the lens of the projector.

Focus/Distortion Operation Screen

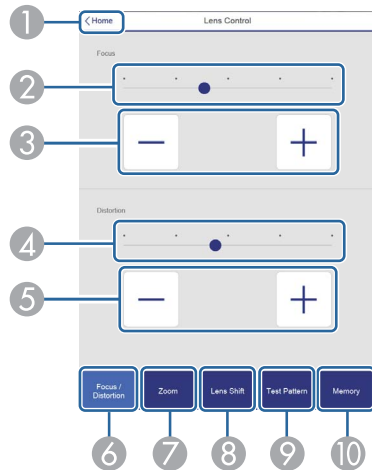

- ① Moves to the Home screen.
 - ② Move the slider to adjust the focus.
 - ③ Press the buttons to adjust the focus.
 - ④ Move the slider to adjust image warping.*
 - ⑤ Press the buttons to adjust image warping.*
 - ⑥ Displays the Focus/Distortion operation screen.
 - ⑦ Displays the Zoom operation screen.
 - ⑧ Displays the Lens Shift operation screen.
 - ⑨ Displays the Test Pattern operation screen.
 - ⑩ Displays the Memory operation screen.
- * This is not available for ELPLU02.

Zoom Operation Screen

This is not available for ELPLX01 and ELPLR04.

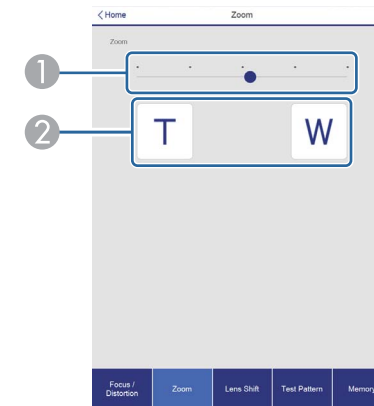

- ① Move the slider to adjust the zoom.
- ② Press the buttons to adjust the zoom.

Lens Shift Operation Screen

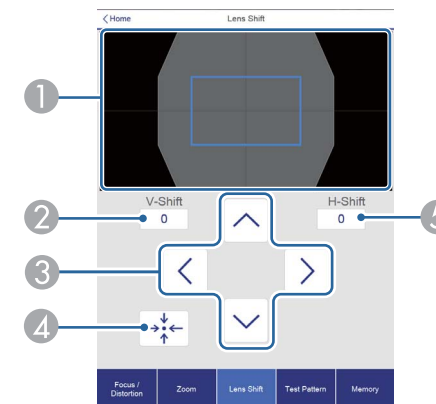

- ① Displays the position of the image as a blue square. When you move the image position, a red square is displayed at the destination.
- ② Displays the vertical image position. You can directly specify the position by tapping it and entering a number.
- ③ Moves the image position up, down, left, or right.

- ④ Moves the lens position to the home position if you press the [OK] button in the confirmation screen.
- ⑤ Displays the horizontal image position. You can directly specify the position by tapping it and entering a number.

Test Pattern Operation Screen

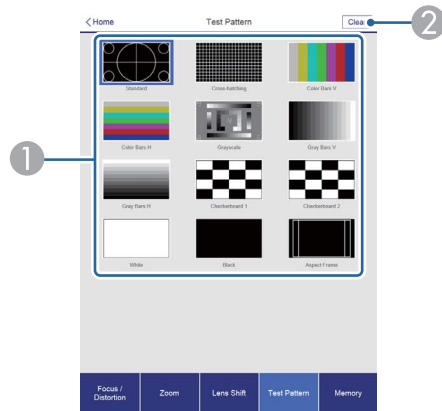

- ① Displays a test pattern.
- ② Closes the test pattern.

Memory Operation Screen

See the following for memory function details.

☛ "Memory Function" [p.121](#)

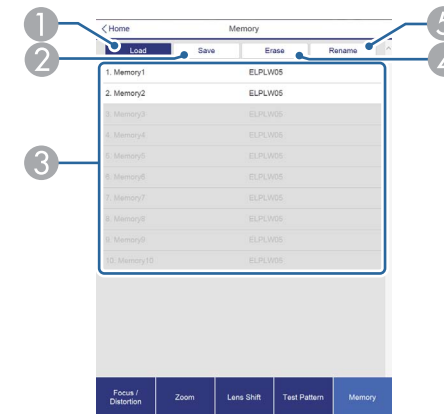

- ① Loads a memory.
- ② Saves a memory.
- ③ Displays a list of memories.
- ④ Erases a memory.
- ⑤ Changes a memory name.

Status Information Screen

You can check the projector's status. See the following for display details.

☛ "Reading the Status Information" [p.170](#)

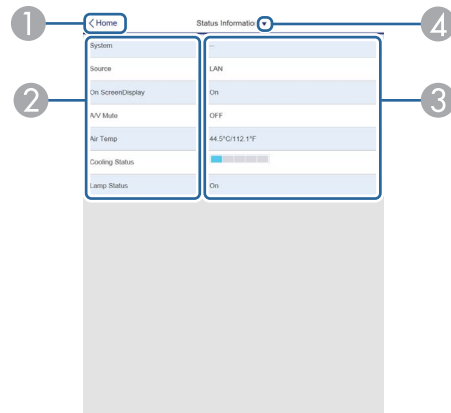

- ① Moves to the Home screen.
- ② Displays the item name.
- ③ Displays the status of each item.
- ④ Selects a category from the following.
Status Information, Source, Signal Information, Network Wired, Network Wireless, Maintenance, Version

Using the Mail Notification Function to Report Problems

When you set Mail Notification, notification messages are sent to the preset email addresses when a problem or warning occurs with a projector. This will enable the operator to be notified of problems with projectors even at locations away from the projectors.

☛ **Network - Notification - Mail Notification** [p.151](#)



- Up to a maximum of three notification destinations (addresses) can be registered, and notification messages can be sent to all three destinations at once.
- If a projector develops a critical problem and suddenly stops working, it may not be able to send a message notifying an operator of the problem.
- If you set **Standby Mode** to **Communication On**, you can control the projector even if it is in standby mode (when the power is off).
☛ **Extended - Standby Mode** [p.140](#)

Reading error notification mail

When the Mail Notification function is set to On and a problem or warning occurs in the projector, the following email will be sent.

Sender: The email address set in **From**

Subject: EPSON Projector

Line 1: The projector name where the problem has occurred

Line 2: The IP address set for the projector where the problem has occurred.

Line 3 and on: Details of the problem

The details of the problem are listed line by line. The main message contents are listed below.

- Clean Air Filter
- Internal error
- Fan related error
- Sensor error
- Lamp cover is open.
- Lamp timer failure

- Lamp out
- Internal temperature error
- High-speed cooling in progress
- Lamp replacement notification
- Low Air Flow
- Low Air Flow Error
- No-signal
No Signal is input to the projector. Check the connection status or check that the power for the signal source is turned on.
- Auto Iris Error
- Power Err. (Ballast)
- Incorrect projection mode
- Projection angle mismatch
- Lens shift error

See the following to deal with problems or warnings.

☛ "Reading the Indicators" [p.164](#)

Management Using SNMP

By setting **SNMP** to **On** in the Configuration menu, notification messages are sent to the specified computer when a problem or warning occurs. This will enable the operator to be notified of problems with projectors even at locations away from the projectors.

☛ **Network - Notification - SNMP** [p.151](#)



- SNMP should be managed by a network administrator or someone who is familiar with the network.
- To use the SNMP function to monitor the projector, you need to install the SNMP manager program on your computer.
- The SNMP Agent for this projector complies with version 1 (SNMPv1).
- The managing function using SNMP cannot be used over wireless LAN in Quick connection mode.
- Up to two destination IP addresses can be saved.

ESC/VP21 Commands

You can control the projector from an external device using ESC/VP21.

Command list

When the power ON command is transmitted to the projector, the power turns on and it enters warm-up mode. When the projector's power has turned on, a colon ":" (3Ah) is returned.

When a command is input, the projector executes the command and returns a ":", and then accepts the next command.

If the command being processed terminates abnormally, an error message is output and a ":" is returned.

The main contents are listed below.

Item		Command	
Power ON/OFF	On	PWR ON	
	Off	PWR OFF	
Signal selection	Computer	Auto	SOURCE 1F
		RGB	SOURCE 11
		Component	SOURCE 14

Item		Command
BNC	Auto	SOURCE BF
	RGB	SOURCE B1
	Component	SOURCE B4
HDMI		SOURCE 30
LAN		SOURCE 53
DVI-D		SOURCE A0
HDBaseT		SOURCE 80
A/V Mute On/Off	On	MUTE ON
	Off	MUTE OFF

Add a Carriage Return (CR) code (0Dh) to the end of each command and transmit.

For more details, contact your local dealer or the nearest address provided in the Epson Projector Contact List.

 [Epson Projector Contact List](#)

Cable layouts

Serial connection

- Connector shape: D-Sub 9-pin (male)

- Projector input port name: RS-232C

<At the projector>

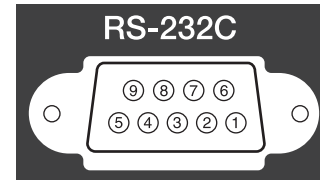

<At the computer>

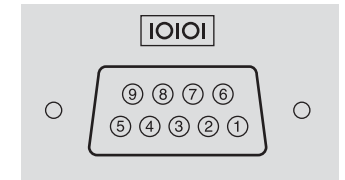

<At the projector>

GND 5
TD 3
RD 2

(PC serial cable)

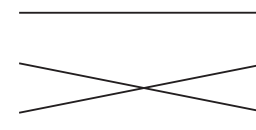

<At the computer>

5 GND
3 TD
2 RD

Signal Name	Function
GND	Signal wire ground
TD	Transmit data
RD	Receive data

Communications protocol

- Default baud rate setting: 9600 bps
- Data length: 8 bit
- Parity: None
- Stop-bit: 1 bit
- Flow control: None

About PJLink

PJLink was established by the JBMIA (Japan Business Machine and Information System Industries Association) as a standard protocol for controlling network-compatible projector's as part of their efforts to standardize projector control protocols.

The projector complies with the PJLink Class2 standard established by the JBMIA.

The port number used for the PJLink search function is 4352 (UDP).

You need to make network settings before you can use PJLink. See the following for more information on network settings.

☛ "Network Menu" p.145

It complies with all commands except for the following commands defined by PJLink Class2, and agreement was confirmed by the PJLink standard adaptability verification.

URL: <http://pjlink.jbmia.or.jp/english/>

• Non-compatible commands

	Function	PJLink Command
Mute settings	Image muting set	AVMT 11
	Audio muting set	AVMT 21

• Input ports and corresponding input source number

Input Port Name	Input Source Number
Computer	11
BNC	13
DVI-D	31
HDMI	32

Input Port Name	Input Source Number
LAN	52
HDBaseT	56

- Manufacturer name displayed for "Manufacture name information query"
EPSON
- Model name displayed for "Product name information query"
EPSON G7905U/G7900U
EPSON G7400U
EPSON G7200W
EPSON G7000W
EPSON G7805/G7800

About Crestron RoomView®

Crestron RoomView® is an integrated control system provided by Crestron®. It can be used to monitor and control multiple devices connected on a network.

The projector supports the control protocol, and can therefore be used in a system built with Crestron RoomView®.

Visit the Crestron® Web site for details on Crestron RoomView®. (Only English-language displays are supported.)

<http://www.crestron.com>

The following provides an overview of Crestron RoomView®.

• Remote operation using a Web browser

You can operate a projector from your computer just like using a remote control.

Monitoring and control with application software

You can use Crestron RoomView® Express or Crestron RoomView® Server Edition provided by Crestron® to monitor devices in the system, to communicate with the help desk, and to send emergency messages. See the following Web site for details.

<http://www.crestron.com/getroomview>

This manual describes how to perform operations on your computer using a Web browser.



- You can only enter single-byte alphanumeric characters and symbols.
- The following functions cannot be used while using Crestron RoomView®.
 - ☛ "Changing Settings Using a Web Browser (Epson Web Control)" p.202
 - Message Broadcasting (EasyMP Monitor plug-in)
- If you set **Standby Mode** to **Communication On**, you can control the projector even if it is in standby mode (when the power is off).
 - ☛ **Extended - Standby Mode** p.140

Operating a projector from your computer

Displaying the operation window

Check the following before carrying out any operations.

- Make sure the computer and projector are connected to the network.
- Set **Crestron RoomView** to **On** from the **Network** menu.
 - ☛ **Network - Others - Crestron RoomView** p.151

1 Start the Web browser on the computer.

2 Enter the IP address of the projector in the address field of the Web browser, and press the Enter key on the keyboard.
The operation window is displayed.

Using the operation window

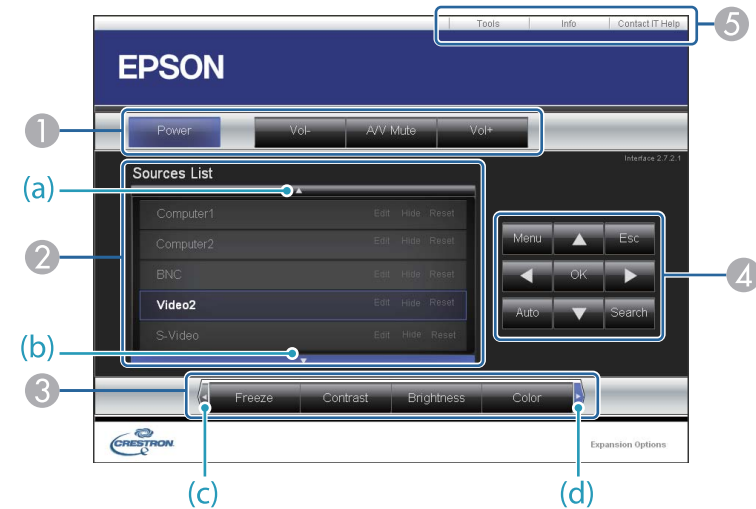



1 You can perform the following operations when you click the buttons.



Button	Function
Power	Turns the projector power on or off.
Vol-/Vol+	Adjusts the volume.

Button	Function
A/V Mute	Turns the video and audio on or off.  "Hiding the Image and Sound Temporarily (A/V Mute)" p.117

- Switch to the image from the selected input source. To display input sources that are not shown in Source List, click (a) or (b) to scroll up or down. The current video signal input source is displayed in blue.
You can change the source name if necessary.
- You can perform the following operations when you click the buttons. To display buttons that are not shown in Source List, click (c) or (d) to scroll left or right.

Button	Function
Freeze	Images are paused or unpaused.  "Freezing the Image (Freeze)" p.118
Contrast	Adjusts the difference between light and shade in the images.
Brightness	Adjusts the image brightness.
Color	Adjusts the color saturation for the images.
Sharpness	Adjusts the image sharpness.
Zoom	Click the [⊕] button to enlarge the image without changing the projection size. Click the [⊖] button to reduce an image that was enlarged with the [⊕] button. Click the [▲] [▼] [◀] [▶] buttons to change the position of an enlarged image.  "Enlarging Part of the Image (E-Zoom)" p.118

- The [▲] [▼] [◀] [▶] buttons perform the same operations as the [▲] [▼] [◀] [▶] buttons on the remote control. You can perform the following operations when you click the other buttons.

Button	Function
OK	Performs the same operation as the [↵] button on the remote control.  "Remote Control" p.19
Menu	Displays and closes the Configuration menu.
Auto	If clicked while projecting analog RGB signals from the Computer port, you can automatically optimize Tracking, Sync., and Position.
Search	Changes to the next input source that is sending an image.  "Automatically Detecting Input Signals and Changing the Projected Image (Source Search)" p.59
Esc	Performs the same operation as the [Esc] button on the remote control.  "Remote Control" p.19

- You can perform the following operations when you click the tabs.

Tab	Function
Contact IT Help	Displays the Help Desk window. Used to send messages to, and receive messages from, the administrator using Crestron RoomView® Express.
Info	Displays information on the projector that is currently connected.
Tools	Changes settings in the projector that is currently connected. See the next section.

Using the tools window

The following window is displayed when you click the **Tools** tab on the operation window. You can use this window to change settings in the projector that is currently connected.

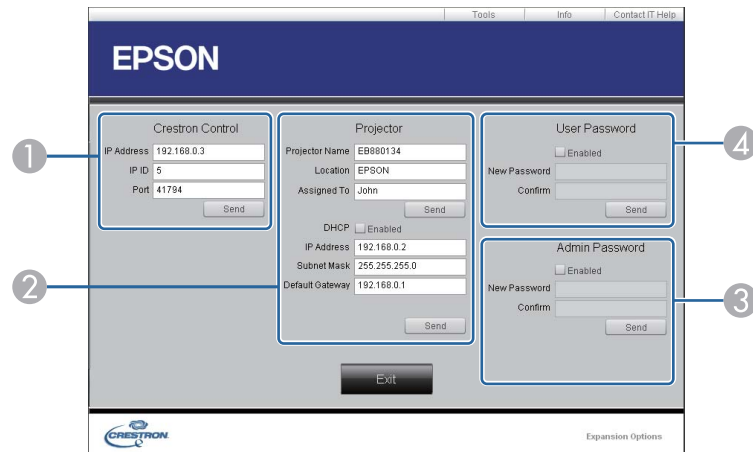

1 Crestron Control
Make settings for Crestron® central controllers.

2 Projector
The following items can be set.

Item	Function
Projector Name	Enter a name to differentiate the projector that is currently connected from other projectors on the network. (The name can contain up to 15 single-byte alphanumeric characters.)
Location	Enter an installation location name for the projector that is currently connected on the network. (The name can contain up to 32 single-byte alphanumeric characters and symbols.)
Assigned To	Enter a user name for the projector. (The name can contain up to 32 single-byte alphanumeric characters and symbols.)

Item	Function
DHCP	Select the Enabled check box to use DHCP. You cannot enter an IP address if DHCP is enabled.
IP Address	Enter the IP address to assign to the currently connected projector.
Subnet Mask	Enter a subnet mask for the currently connected projector.
Default Gateway	Enter the gateway address for the currently connected projector.
Send	Click this button to confirm the changes made to the Projector .

3 Admin Password
Select the **Enabled** check box to require a password to open the Tools window. The following items can be set.

Item	Function
New Password	Enter the new password when changing the password to open the Tools window. (The name can contain up to 26 single-byte alphanumeric characters.)
Confirm	Enter the same password as you entered in New Password . If the passwords are not the same, an error is displayed.
Send	Click this button to confirm the changes made to the Admin Password .

4 User Password
Select the **Enabled** check box to require a password to open the operation window on the computer. The following items can be set.

Item	Function
New Password	Enter the new password when changing the password to open the operation window. (The name can contain up to 26 single-byte alphanumeric characters.)
Confirm	Enter the same password as you entered in New Password . If the passwords are not the same, an error is displayed.
Send	Click this button to confirm the changes made to the User Password .

The following optional accessories and consumables are available. Please purchase these products as and when needed. The following list of optional accessories and consumables is current as of: January 2016. Details of accessories are subject to change without notice and availability may vary depending on the country of purchase.

Optional Accessories

Lens unit

ELPLX01, ELPLU03, ELPLU04, ELPLW05, ELPLW06, ELPLM08, ELPLM09, ELPLM10, ELPLM11, ELPLL08

See the following for more information on the projection distance for each lens.

☛ "Screen Size and Projection Distance" [p.217](#)

Computer cable ELPKC02

(1.8 m - for mini D-Sub15-pin/mini D-Sub 15pin)

This is the same as the computer cable supplied with the projector.

Computer cable ELPKC09

(3 m - for mini D-Sub15-pin/mini D-Sub 15pin)

Computer cable ELPKC10

(20 m - for mini D-Sub15-pin/mini D-Sub 15pin)

Use one of these longer cables if the computer cable supplied with the projector is too short.

Component video cable ELPKC19

(3 m - for mini D-Sub 15-pin/RCA male×3)

Use to connect a [Component Video](#) source.

Remote control cable set ELPKC28

(10 m 2 piece set)

Use this to guarantee operation from the remote control from a distance.

Wireless mouse receiver ELPST16

Use this to use the projector's remote control to control the mouse pointer on the computer or to page up and down.

HDBaseT Transmitter ELPHD01

This transmitter performs long distance transmissions for HDMI signals and control signals for one LAN cable. Based on the [HDBaseT](#) standard. (HDCP 2.2 is not supported.)

Wireless LAN unit ELPAP10

Use when connecting the projector to a computer wirelessly and projecting.

Quick Wireless Connection USB Key ELPAP09

Use when you want to quickly establish one-to-one connection between the projector and a computer with Windows installed.

Polarizer ELPPL01

Use when stacking two projectors and projecting 3D images.

Passive 3D Glasses (standard five piece set) ELPGS02A

Passive 3D Glasses (five piece set for children) ELPGS02B

Passive polarized 3D glasses. Use these when viewing 3D images with the projectors.

Document Camera ELPDC13, ELPDC21

Use when projecting images such as books, OHP documents, or slides.

Ceiling pipe (450 mm)* ELPFP13

Ceiling pipe (700 mm)* ELPFP14

Use when installing the projector on a high ceiling.

Ceiling mount* ELPMB22

Low ceiling mount* ELPMB47

High ceiling mount* ELPMB48

Use when installing the projector on a ceiling.

* Special expertise is required to suspend the projector from a ceiling. Contact your local dealer or the nearest address provided in the Epson Projector Contact List.

☛ [Epson Projector Contact List](#)



Consumables

Lamp unit ELPLP93

Use as a replacement for used lamps.

Air filter ELPAF30

Use as a replacement for used air filters.

Projection Distance for EB-G7900U/EB-G7400U/EB-G7200W/EB-G7000W

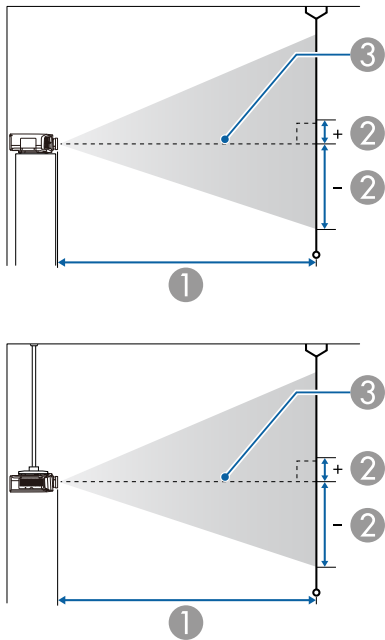

- ① Projection distance
- ② is the distance from the center of the lens to the base of the screen. This changes depending on the setting for vertical lens shift.
- ③ Center of lens

ELPLM08

This section shows the projection distances for models equipped with lenses.

Unit: cm

4:3 Screen Size		①	②
		Minimum (Wide) to Maximum (Tele)	Vertical Lens Shift Bottom to Top
45"	100x75	156 to 253	-81 to +12
50"	102x76	174 to 281	-90 to +13
60"	122x91	210 to 338	-108 to +16
80"	163x122	281 to 453	-143 to +22
100"	203x152	353 to 567	-179 to +27
120"	244x183	424 to 681	-215 to +32
150"	305x229	532 to 853	-269 to +40
200"	406x305	711 to 1139	-359 to +54
250"	508x381	890 to 1424	-448 to +67
265"	539x404	943 to 1510	-475 to +71

Unit: cm

16:9 Screen Size		①	②
		Minimum (Wide) to Maximum (Tele)	Vertical Lens Shift Bottom to Top
49"	108x61	154 to 250	-76 to +15
50"	111x62	157 to 255	-78 to +16
60"	133x75	190 to 307	-94 to +19
80"	177x100	255 to 411	-125 to +25
100"	221x125	320 to 514	-156 to +31
120"	266x149	385 to 618	-187 to +38



16:9 Screen Size		①	②
		Minimum (Wide) to Maximum (Tele)	Vertical Lens Shift Bottom to Top
150"	332x187	482 to 774	-234 to +47
200"	443x249	645 to 1033	-312 to +63
250"	553x311	807 to 1293	-390 to +78
290"	642x361	937 to 1500	-452 to +91

Unit: cm

16:10 Screen Size		①	②
		Minimum (Wide) to Maximum (Tele)	Vertical Lens Shift Bottom to Top
50"	108x67	153 to 248	-79 to +12
60"	130x81	185 to 298	-95 to +14
80"	172x108	248 to 399	-127 to +19
100"	215x135	311 to 500	-158 to +24
120"	258x162	374 to 601	-190 to +29
150"	323x202	469 to 753	-238 to +36
200"	431x269	627 to 1005	-317 to +48
250"	538x337	785 to 1258	-396 to +59
300"	646x404	943 to 1510	-475 to +71

ELPLX01

See the user's guide supplied with the lens unit.

ELPLU03

Unit: cm

4:3 Screen Size		①	②
		Minimum (Wide) to Maximum (Tele)	Vertical Lens Shift Bottom to Top
71"	144x108	112 to 135	-127 to +19
80"	163x122	126 to 152	-143 to +22
100"	203x152	159 to 191	-179 to +27
120"	244x183	191 to 230	-215 to +32
150"	305x229	240 to 289	-269 to +40
200"	406x305	321 to 386	-359 to +54
250"	508x381	403 to 483	-448 to +67
265"	539x404	427 to 513	-475 to +71

Unit: cm

16:9 Screen Size		①	②
		Minimum (Wide) to Maximum (Tele)	Vertical Lens Shift Bottom to Top
78"	173x97	111 to 134	-122 to +24
80"	177x100	114 to 138	-125 to +25
100"	221x125	144 to 173	-156 to +31
120"	266x149	173 to 209	-187 to +38
150"	332x187	218 to 262	-234 to +47
200"	443x249	291 to 350	-312 to +63
250"	553x311	365 to 439	-390 to +78
290"	642x361	424 to 509	-452 to +91



Unit: cm

16:10 Screen Size		①	②
		Minimum (Wide) to Maximum (Tele)	Vertical Lens Shift Bottom to Top
80"	172x108	111 to 134	-127 to +19
100"	215x135	140 to 168	-158 to +24
120"	258x162	169 to 203	-190 to +29
150"	323x202	212 to 255	-238 to +36
200"	431x269	283 to 341	-317 to +48
250"	538x337	355 to 427	-396 to +59
300"	646x404	427 to 513	-475 to +71

Unit: cm

16:9 Screen Size		①	②
		Minimum (Wide) to Maximum (Tele)	Vertical Lens Shift Bottom to Top
49"	108x61	92 to 112	-76 to +15
50"	111x62	94 to 114	-78 to +16
60"	133x75	114 to 138	-94 to +19
80"	177x100	154 to 186	-125 to +25
100"	221x125	194 to 234	-156 to +31
120"	266x149	234 to 282	-187 to +38
150"	332x187	293 to 354	-234 to +47
200"	443x249	393 to 473	-312 to +63
250"	553x311	493 to 593	-390 to +78
290"	642x361	573 to 689	-452 to +91

ELPLU04/ELPLU02

Unit: cm

4:3 Screen Size		①	②
		Minimum (Wide) to Maximum (Tele)	Vertical Lens Shift Bottom to Top
45"	100x75	93 to 113	-81 to +12
50"	102x76	104 to 126	-90 to +13
60"	122x91	126 to 153	-108 to +16
80"	163x122	170 to 205	-143 to +22
100"	203x152	214 to 258	-179 to +27
120"	244x183	258 to 311	-215 to +32
150"	305x229	324 to 390	-269 to +40
200"	406x305	434 to 522	-359 to +54
250"	508x381	543 to 654	-448 to +67
265"	539x404	576 to 693	-475 to +71

Unit: cm

16:10 Screen Size		①	②
		Minimum (Wide) to Maximum (Tele)	Vertical Lens Shift Bottom to Top
50"	108x67	91 to 111	-79 to +12
60"	130x81	111 to 134	-95 to +14
80"	172x108	149 to 181	-127 to +19
100"	215x135	188 to 227	-158 to +24
120"	258x162	227 to 274	-190 to +29
150"	323x202	285 to 344	-238 to +36
200"	431x269	382 to 460	-317 to +48
250"	538x337	479 to 577	-396 to +59
300"	646x404	576 to 693	-475 to +71



ELPLW05

Unit: cm

4:3 Screen Size		①	②
		Minimum (Wide) to Maximum (Tele)	Vertical Lens Shift Bottom to Top
45"	100x75	111 to 158	-81 to +12
50"	102x76	124 to 176	-90 to +13
60"	122x91	150 to 212	-108 to +16
80"	163x122	203 to 285	-143 to +22
100"	203x152	255 to 357	-179 to +27
120"	244x183	308 to 430	-215 to +32
150"	305x229	387 to 539	-269 to +40
200"	406x305	519 to 720	-359 to +54
250"	508x381	650 to 902	-448 to +67
265"	539x404	690 to 956	-475 to +71

Unit: cm

16:9 Screen Size		①	②
		Minimum (Wide) to Maximum (Tele)	Vertical Lens Shift Bottom to Top
49"	108x61	109 to 156	-76 to +15
50"	111x62	112 to 159	-78 to +16
60"	133x75	136 to 192	-94 to +19
80"	177x100	183 to 258	-125 to +25
100"	221x125	231 to 324	-156 to +31
120"	266x149	279 to 390	-187 to +38
150"	332x187	351 to 489	-234 to +47
200"	443x249	470 to 653	-312 to +63

16:9 Screen Size		①	②
		Minimum (Wide) to Maximum (Tele)	Vertical Lens Shift Bottom to Top
250"	553x311	590 to 818	-390 to +78
290"	642x361	685 to 950	-452 to +91

Unit: cm

16:10 Screen Size		①	②
		Minimum (Wide) to Maximum (Tele)	Vertical Lens Shift Bottom to Top
50"	108x67	109 to 155	-79 to +12
60"	130x81	132 to 187	-95 to +14
80"	172x108	178 to 251	-127 to +19
100"	215x135	225 to 315	-158 to +24
120"	258x162	271 to 379	-190 to +29
150"	323x202	341 to 475	-238 to +36
200"	431x269	457 to 636	-317 to +48
250"	538x337	573 to 796	-396 to +59
300"	646x404	690 to 956	-475 to +71

ELPLW06/ELPLW04

Unit: cm

4:3 Screen Size		①	②
		Minimum (Wide) to Maximum (Tele)	Vertical Lens Shift Bottom to Top
45"	97x61	175 to 240	-81 to +12
50"	102x76	195 to 267	-90 to +13
60"	122x91	236 to 322	-108 to +16



4:3 Screen Size		①	②
		Minimum (Wide) to Maximum (Tele)	Vertical Lens Shift Bottom to Top
80"	163x122	317 to 432	-143 to +22
100"	203x152	398 to 543	-179 to +27
120"	244x183	479 to 653	-215 to +32
150"	305x229	600 to 818	-269 to +40
200"	406x305	803 to 1094	-359 to +54
250"	508x381	1005 to 1369	-448 to +67
265"	539x404	1066 to 1452	-475 to +71

Unit: cm

16:9 Screen Size		①	②
		Minimum (Wide) to Maximum (Tele)	Vertical Lens Shift Bottom to Top
49"	108x61	173 to 237	-76 to +15
50"	111x62	176 to 242	-78 to +16
60"	133x75	213 to 292	-94 to +19
80"	177x100	287 to 392	-125 to +25
100"	221x125	360 to 492	-156 to +31
120"	266x149	434 to 592	-187 to +38
150"	332x187	544 to 742	-234 to +47
200"	443x249	728 to 992	-312 to +63
250"	553x311	912 to 1242	-390 to +78
290"	642x361	1059 to 1442	-452 to +91

Unit: cm

16:10 Screen Size		①	②
		Minimum (Wide) to Maximum (Tele)	Vertical Lens Shift Bottom to Top
50"	108x67	172 to 235	-79 to +12
60"	130x81	207 to 284	-95 to +14
80"	172x108	279 to 381	-127 to +19
100"	215x135	350 to 478	-158 to +24
120"	258x162	422 to 576	-190 to +29
150"	323x202	529 to 722	-238 to +36
200"	431x269	708 to 965	-317 to +48
250"	538x337	887 to 1208	-396 to +59
300"	646x404	1066 to 1452	-475 to +71

ELPLM09/ELPLS04

Unit: cm

4:3 Screen Size		①	②
		Minimum (Wide) to Maximum (Tele)	Vertical Lens Shift Bottom to Top
45"	100x75	233 to 379	-81 to +12
50"	102x76	260 to 422	-90 to +13
60"	122x91	313 to 508	-108 to +16
80"	163x122	420 to 679	-143 to +22
100"	203x152	527 to 851	-179 to +27
120"	244x183	635 to 1023	-215 to +32
150"	305x229	795 to 1281	-269 to +40
200"	406x305	1063 to 1711	-359 to +54
250"	508x381	1331 to 2140	-448 to +67

4:3 Screen Size		①	②
		Minimum (Wide) to Maximum (Tele)	Vertical Lens Shift Bottom to Top
265"	539x404	1411 to 2269	-475 to +71

Unit: cm

16:9 Screen Size		①	②
		Minimum (Wide) to Maximum (Tele)	Vertical Lens Shift Bottom to Top
49"	108x61	230 to 374	-76 to +15
50"	111x62	235 to 382	-78 to +16
60"	133x75	284 to 460	-94 to +19
80"	177x100	381 to 616	-125 to +25
100"	221x125	478 to 772	-156 to +31
120"	266x149	575 to 928	-187 to +38
150"	332x187	721 to 1162	-234 to +47
200"	443x249	964 to 1552	-312 to +63
250"	553x311	1207 to 1942	-390 to +78
290"	642x361	1402 to 2254	-452 to +91

Unit: cm

16:10 Screen Size		①	②
		Minimum (Wide) to Maximum (Tele)	Vertical Lens Shift Bottom to Top
50"	108x67	229 to 372	-79 to +12
60"	130x81	276 to 447	-95 to +14
80"	172x108	370 to 599	-127 to +19
100"	215x135	465 to 751	-158 to +24
120"	258x162	560 to 903	-190 to +29

16:10 Screen Size		①	②
		Minimum (Wide) to Maximum (Tele)	Vertical Lens Shift Bottom to Top
150"	323x202	702 to 1131	-238 to +36
200"	431x269	938 to 1510	-317 to +48
250"	538x337	1175 to 1890	-396 to +59
300"	646x404	1411 to 2269	-475 to +71

ELPLM10/ELPLM06

Unit: cm

4:3 Screen Size		①	②
		Minimum (Wide) to Maximum (Tele)	Vertical Lens Shift Bottom to Top
45"	100x75	359 to 549	-81 to +12
50"	102x76	400 to 611	-90 to +13
60"	122x91	483 to 736	-108 to +16
80"	163x122	648 to 986	-143 to +22
100"	203x152	813 to 1236	-179 to +27
120"	244x183	979 to 1485	-215 to +32
150"	305x229	1227 to 1860	-269 to +40
200"	406x305	1640 to 2484	-359 to +54
250"	508x381	2053 to 3109	-448 to +67
265"	539x404	2177 to 3296	-475 to +71



Unit: cm

16:9 Screen Size		①	②
		Minimum (Wide) to Maximum (Tele)	Vertical Lens Shift Bottom to Top
49"	108x61	355 to 542	-76 to +15
50"	111x62	362 to 554	-78 to +16
60"	133x75	437 to 667	-94 to +19
80"	177x100	587 to 894	-125 to +25
100"	221x125	737 to 1121	-156 to +31
120"	266x149	887 to 1347	-187 to +38
150"	332x187	1112 to 1687	-234 to +47
200"	443x249	1488 to 2254	-312 to +63
250"	553x311	1863 to 2821	-390 to +78
290"	642x361	2163 to 3275	-452 to +91

Unit: cm

16:10 Screen Size		①	②
		Minimum (Wide) to Maximum (Tele)	Vertical Lens Shift Bottom to Top
50"	108x67	352 to 538	-79 to +12
60"	130x81	425 to 649	-95 to +14
80"	172x108	571 to 869	-127 to +19
100"	215x135	717 to 1090	-158 to +24
120"	258x162	863 to 1311	-190 to +29
150"	323x202	1082 to 1641	-238 to +36
200"	431x269	1447 to 2193	-317 to +48
250"	538x337	1812 to 2744	-396 to +59
300"	646x404	2177 to 3296	-475 to +71

ELPLM11/ELPLM07

Unit: cm

4:3 Screen Size		①	②
		Minimum (Wide) to Maximum (Tele)	Vertical Lens Shift Bottom to Top
45"	100x75	521 to 799	-81 to +12
50"	102x76	582 to 890	-90 to +13
60"	122x91	703 to 1073	-108 to +16
80"	163x122	945 to 1438	-143 to +22
100"	203x152	1188 to 1804	-179 to +27
120"	244x183	1430 to 2169	-215 to +32
150"	305x229	1793 to 2717	-269 to +40
200"	406x305	2399 to 3631	-359 to +54
250"	508x381	3005 to 4544	-448 to +67
265"	539x404	3186 to 4819	-475 to +71

Unit: cm

16:9 Screen Size		①	②
		Minimum (Wide) to Maximum (Tele)	Vertical Lens Shift Bottom to Top
49"	108x61	515 to 789	-76 to +15
50"	111x62	526 to 806	-78 to +16
60"	133x75	636 to 972	-94 to +19
80"	177x100	856 to 1304	-125 to +25
100"	221x125	1076 to 1635	-156 to +31
120"	266x149	1296 to 1967	-187 to +38
150"	332x187	1626 to 2465	-234 to +47
200"	443x249	2176 to 3294	-312 to +63



16:9 Screen Size		①	②
		Minimum (Wide) to Maximum (Tele)	Vertical Lens Shift Bottom to Top
250"	553x311	2726 to 4124	-390 to +78
290"	642x361	3166 to 4787	-452 to +91

Unit: cm

16:10 Screen Size		①	②
		Minimum (Wide) to Maximum (Tele)	Vertical Lens Shift Bottom to Top
50"	108x67	511 to 784	-79 to +12
60"	130x81	618 to 945	-95 to +14
80"	172x108	832 to 1268	-127 to +19
100"	215x135	1046 to 1591	-158 to +24
120"	258x162	1260 to 1913	-190 to +29
150"	323x202	1581 to 2398	-238 to +36
200"	431x269	2116 to 3205	-317 to +48
250"	538x337	2651 to 4012	-396 to +59
300"	646x404	3186 to 4819	-475 to +71

Unit: cm

ELPLL08/ELPLL07

4:3 Screen Size		①	②
		Minimum (Wide) to Maximum (Tele)	Vertical Lens Shift Bottom to Top
45"	100x75	776 to 1095	-81 to +12
50"	102x76	866 to 1220	-90 to +13
60"	122x91	1046 to 1470	-108 to +16

4:3 Screen Size		①	②
		Minimum (Wide) to Maximum (Tele)	Vertical Lens Shift Bottom to Top
80"	163x122	1405 to 1971	-143 to +22
100"	203x152	1764 to 2472	-179 to +27
120"	244x183	2124 to 2972	-215 to +32
150"	305x229	2662 to 3724	-269 to +40
200"	406x305	3561 to 4975	-359 to +54
250"	508x381	4459 to 6227	-448 to +67
265"	539x404	4728 to 6602	-475 to +71

Unit: cm

16:9 Screen Size		①	②
		Minimum (Wide) to Maximum (Tele)	Vertical Lens Shift Bottom to Top
49"	108x61	767 to 1082	-76 to +15
50"	111x62	784 to 1105	-78 to +16
60"	133x75	947 to 1332	-94 to +19
80"	177x100	1273 to 1787	-125 to +25
100"	221x125	1599 to 2241	-156 to +31
120"	266x149	1925 to 2696	-187 to +38
150"	332x187	2414 to 3378	-234 to +47
200"	443x249	3230 to 4514	-312 to +63
250"	553x311	4045 to 5650	-390 to +78
290"	642x361	4697 to 6560	-452 to +91



Unit: cm

16:10 Screen Size		①	②
		Minimum (Wide) to Maximum (Tele)	Vertical Lens Shift Bottom to Top
50"	108x67	761 to 1074	-79 to +12
60"	130x81	920 to 1295	-95 to +14
80"	172x108	1237 to 1737	-127 to +19
100"	215x135	1555 to 2180	-158 to +24
120"	258x162	1872 to 2622	-190 to +29
150"	323x202	2348 to 3285	-238 to +36
200"	431x269	3141 to 4391	-317 to +48
250"	538x337	3935 to 5497	-396 to +59
300"	646x404	4728 to 6602	-475 to +71

4:3 Screen Size		①	②
265"	538x404	629	-202

Unit: cm

16:9 Screen Size		①	②
49"	108x61	101	-30
50"	111x62	103	-31
60"	133x75	124	-37
80"	177x100	168	-50
100"	221x125	212	-62
120"	266x149	255	-75
150"	332x187	320	-93
200"	443x249	429	-125
250"	553x311	538	-156
290"	642x361	625	-181

ELPLR04

Lens shift is not supported.

Unit: cm

4:3 Screen Size		①	②
45"	91x69	102	-34
50"	102x76	114	-38
60"	122x91	138	-46
80"	163x122	186	-61
100"	203x152	234	-76
120"	244x183	282	-91
150"	305x229	354	-114
200"	406x305	473	-152
250"	508x381	593	-191

Unit: cm

16:10 Screen Size		①	②
50"	108x67	100	-33
60"	130x81	121	-40
80"	172x108	163	-54
100"	215x135	206	-67
120"	258x162	248	-81
150"	323x202	312	-101
200"	431x269	417	-135
250"	538x337	523	-168
300"	646x404	629	-202

Projection Distance for EB-G7800

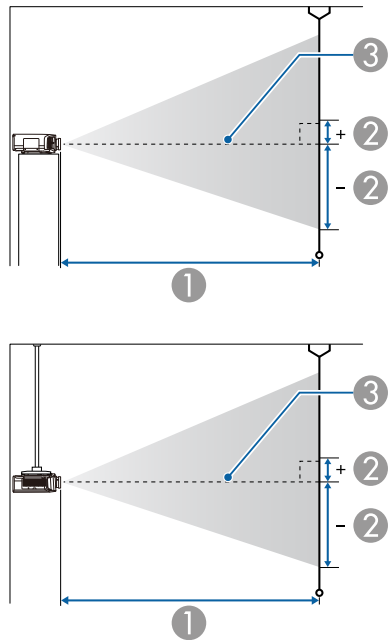

- ① Projection distance
- ② is the distance from the center of the lens to the base of the screen. This changes depending on the setting for vertical lens shift.
- ③ Center of lens

ELPLM08

This section shows the projection distances for models equipped with standard lenses.

Unit: cm

4:3 Screen Size		①	②
		Minimum (Wide) to Maximum (Tele)	Vertical Lens Shift Bottom to Top
50"	102x76	147 to 239	-82 to +6
60"	122x91	178 to 288	-98 to +7
80"	163x122	239 to 385	-131 to +9
100"	203x152	299 to 482	-164 to +12
120"	244x183	360 to 580	-197 to +14
150"	305x229	452 to 726	-246 to +17
200"	406x305	604 to 969	-328 to +23
250"	508x381	756 to 1213	-410 to +29
300"	610x457	908 to 1456	-492 to +35

Unit: cm

16:9 Screen Size		①	②
		Minimum (Wide) to Maximum (Tele)	Vertical Lens Shift Bottom to Top
46"	102x57	148 to 240	-73 to +15
50"	111x62	161 to 261	-79 to +17
60"	133x75	194 to 314	-95 to +20
80"	177x100	260 to 420	-126 to +27
100"	221x125	327 to 526	-158 to +33
120"	266x149	393 to 632	-189 to +40
150"	332x187	493 to 791	-237 to +50
200"	443x249	658 to 1057	-316 to +67
250"	553x311	824 to 1322	-395 to +83
275"	609x342	907 to 1454	-434 to +92

Unit: cm

16:10 Screen Size		①	②
		Minimum (Wide) to Maximum (Tele)	Vertical Lens Shift Bottom to Top
48"	103x65	150 to 243	-77 to +12
50"	108x67	156 to 254	-80 to +13
60"	130x81	189 to 305	-96 to +15
80"	172x108	253 to 408	-128 to +21
100"	215x135	318 to 512	-160 to +26
120"	258x162	382 to 615	-192 to +31
150"	323x202	479 to 770	-241 to +39
200"	431x269	640 to 1028	-321 to +51
250"	538x337	802 to 1286	-401 to +64
280"	603x377	899 to 1441	-449 to +72

ELPLX01

See the user's guide supplied with the lens unit.

ELPLU03

Unit: cm

4:3 Screen Size		①	②
		Minimum (Wide) to Maximum (Tele)	Vertical Lens Shift Bottom to Top
80"	163x122	107 to 129	-131 to +9
100"	203x152	134 to 162	-164 to +12
120"	244x183	162 to 196	-197 to +14
150"	305x229	204 to 245	-246 to +17

4:3 Screen Size		①	②
		Minimum (Wide) to Maximum (Tele)	Vertical Lens Shift Bottom to Top
200"	406x305	273 to 328	-328 to +23
250"	508x381	342 to 411	-410 to +29
300"	610x457	411 to 494	-492 to +35

Unit: cm

16:9 Screen Size		①	②
		Minimum (Wide) to Maximum (Tele)	Vertical Lens Shift Bottom to Top
74"	164x92	108 to 130	-117 to +25
80"	177x100	117 to 141	-126 to +27
100"	221x125	147 to 177	-158 to +33
120"	266x149	177 to 213	-189 to +40
150"	332x187	222 to 268	-237 to +50
200"	443x249	297 to 358	-316 to +67
250"	553x311	373 to 448	-395 to +83
275"	609x342	410 to 493	-434 to +92

Unit: cm

16:10 Screen Size		①	②
		Minimum (Wide) to Maximum (Tele)	Vertical Lens Shift Bottom to Top
76"	164x102	108 to 130	-122 to +20
80"	172x108	113 to 137	-128 to +21
100"	215x135	143 to 172	-160 to +26
120"	258x162	172 to 208	-192 to +31
150"	323x202	216 to 260	-241 to +39



16:10 Screen Size		①	②
		Minimum (Wide) to Maximum (Tele)	Vertical Lens Shift Bottom to Top
200"	431x269	289 to 348	-321 to +51
250"	538x337	362 to 436	-401 to +64
280"	603x377	406 to 489	-449 to +72

16:9 Screen Size		①	②
		Minimum (Wide) to Maximum (Tele)	Vertical Lens Shift Bottom to Top
60"	133x75	117 to 141	-95 to +20
80"	177x100	157 to 191	-126 to +27
100"	221x125	198 to 240	-158 to +33
120"	266x149	239 to 289	-189 to +40
150"	332x187	300 to 362	-237 to +50
200"	443x249	402 to 485	-316 to +67
250"	553x311	504 to 607	-395 to +83
275"	609x342	555 to 669	-434 to +92

ELPLU04/ELPLU02

Unit: cm

4:3 Screen Size		①	②
		Minimum (Wide) to Maximum (Tele)	Vertical Lens Shift Bottom to Top
50"	102x76	88 to 107	-82 to +6
60"	122x91	107 to 129	-98 to +7
80"	163x122	144 to 174	-131 to +9
100"	203x152	181 to 219	-164 to +12
120"	244x183	219 to 264	-197 to +14
150"	305x229	275 to 332	-246 to +17
200"	406x305	368 to 444	-328 to +23
250"	508x381	462 to 557	-410 to +29
300"	610x457	555 to 669	-492 to +35

Unit: cm

16:10 Screen Size		①	②
		Minimum (Wide) to Maximum (Tele)	Vertical Lens Shift Bottom to Top
48"	103x65	90 to 109	-77 to +12
50"	108x67	93 to 114	-80 to +13
60"	130x81	113 to 138	-96 to +15
80"	172x108	153 to 185	-128 to +21
100"	215x135	193 to 233	-160 to +26
120"	258x162	232 to 281	-192 to +31
150"	323x202	292 to 352	-241 to +39
200"	431x269	391 to 471	-321 to +51
250"	538x337	490 to 591	-401 to +64
280"	603x377	549 to 662	-449 to +72

Unit: cm

16:9 Screen Size		①	②
		Minimum (Wide) to Maximum (Tele)	Vertical Lens Shift Bottom to Top
46"	102x57	88 to 107	-73 to +15
50"	111x62	96 to 117	-79 to +17



ELPLW05

Unit: cm

4:3 Screen Size		①	②
		Minimum (Wide) to Maximum (Tele)	Vertical Lens Shift Bottom to Top
50"	102x76	104 to 149	-82 to +6
60"	122x91	127 to 180	-98 to +7
80"	163x122	171 to 242	-131 to +9
100"	203x152	216 to 303	-164 to +12
120"	244x183	261 to 365	-197 to +14
150"	305x229	328 to 458	-246 to +17
200"	406x305	440 to 612	-328 to +23
250"	508x381	552 to 767	-410 to +29
300"	610x457	664 to 922	-492 to +35

Unit: cm

16:9 Screen Size		①	②
		Minimum (Wide) to Maximum (Tele)	Vertical Lens Shift Bottom to Top
46"	102x57	104 to 149	-73 to +15
50"	111x62	114 to 163	-79 to +17
60"	133x75	139 to 196	-95 to +20
80"	177x100	187 to 264	-126 to +27
100"	221x125	236 to 331	-158 to +33
120"	266x149	285 to 398	-189 to +40
150"	332x187	358 to 499	-237 to +50
200"	443x249	480 to 668	-316 to +67
250"	553x311	602 to 836	-395 to +83

16:9 Screen Size		①	②
		Minimum (Wide) to Maximum (Tele)	Vertical Lens Shift Bottom to Top
275"	609x342	663 to 920	-434 to +92

Unit: cm

16:10 Screen Size		①	②
		Minimum (Wide) to Maximum (Tele)	Vertical Lens Shift Bottom to Top
48"	103x65	106 to 151	-77 to +12
50"	108x67	111 to 158	-80 to +13
60"	130x81	135 to 191	-96 to +15
80"	172x108	182 to 256	-128 to +21
100"	215x135	230 to 322	-160 to +26
120"	258x162	277 to 387	-192 to +31
150"	323x202	348 to 486	-241 to +39
200"	431x269	467 to 650	-321 to +51
250"	538x337	586 to 813	-401 to +64
280"	603x377	657 to 912	-449 to +72

ELPLW06/ELPLW04

Unit: cm

4:3 Screen Size		①	②
		Minimum (Wide) to Maximum (Tele)	Vertical Lens Shift Bottom to Top
50"	102x76	165 to 227	-82 to +6
60"	122x91	199 to 274	-98 to +7
80"	163x122	268 to 368	-131 to +9

4:3 Screen Size		①	②
		Minimum (Wide) to Maximum (Tele)	Vertical Lens Shift Bottom to Top
100"	203x152	337 to 461	-164 to +12
120"	244x183	406 to 555	-197 to +14
150"	305x229	509 to 696	-246 to +17
200"	406x305	682 to 930	-328 to +23
250"	508x381	854 to 1164	-410 to +29
300"	610x457	1026 to 1398	-492 to +35

Unit: cm

16:9 Screen Size		①	②
		Minimum (Wide) to Maximum (Tele)	Vertical Lens Shift Bottom to Top
46"	102x57	165 to 228	-73 to +15
50"	111x62	180 to 248	-79 to +17
60"	133x75	218 to 299	-95 to +20
80"	177x100	293 to 401	-126 to +27
100"	221x125	368 to 503	-158 to +33
120"	266x149	443 to 605	-189 to +40
150"	332x187	556 to 759	-237 to +50
200"	443x249	743 to 1014	-316 to +67
250"	553x311	931 to 1269	-395 to +83
275"	609x342	1025 to 1397	-434 to +92

Unit: cm

16:10 Screen Size		①	②
		Minimum (Wide) to Maximum (Tele)	Vertical Lens Shift Bottom to Top
48"	98x73	168 to 231	-77 to +12
50"	108x67	175 to 241	-80 to +13
60"	130x81	212 to 291	-96 to +15
80"	172x108	285 to 390	-128 to +21
100"	215x135	358 to 489	-160 to +26
120"	258x162	431 to 589	-192 to +31
150"	323x202	540 to 738	-241 to +39
200"	431x269	723 to 986	-321 to +51
250"	538x337	906 to 1234	-401 to +64
280"	603x377	1015 to 1383	-449 to +72

ELPLM09/ELPLS04

Unit: cm

4:3 Screen Size		①	②
		Minimum (Wide) to Maximum (Tele)	Vertical Lens Shift Bottom to Top
50"	102x76	219 to 358	-82 to +6
60"	122x91	265 to 431	-98 to +7
80"	163x122	356 to 578	-131 to +9
100"	203x152	447 to 724	-164 to +12
120"	244x183	538 to 870	-197 to +14
150"	305x229	674 to 1090	-246 to +17
200"	406x305	902 to 1456	-328 to +23
250"	508x381	1129 to 1822	-410 to +29



4:3 Screen Size		①	②
		Minimum (Wide) to Maximum (Tele)	Vertical Lens Shift Bottom to Top
300"	610x457	1357 to 2188	-492 to +35

Unit: cm

16:9 Screen Size		①	②
		Minimum (Wide) to Maximum (Tele)	Vertical Lens Shift Bottom to Top
46"	102x57	220 to 359	-73 to +15
50"	111x62	240 to 391	-79 to +17
60"	133x75	289 to 471	-95 to +20
80"	177x100	389 to 630	-126 to +27
100"	221x125	488 to 790	-158 to +33
120"	266x149	587 to 949	-189 to +40
150"	332x187	736 to 1188	-237 to +50
200"	443x249	983 to 1587	-316 to +67
250"	553x311	1231 to 1986	-395 to +83
275"	609x342	1355 to 2185	-434 to +92

Unit: cm

16:10 Screen Size		①	②
		Minimum (Wide) to Maximum (Tele)	Vertical Lens Shift Bottom to Top
48"	103x65	223 to 364	-77 to +12
50"	108x67	233 to 380	-80 to +13
60"	130x81	281 to 458	-96 to +15
80"	172x108	378 to 613	-128 to +21
100"	215x135	474 to 768	-160 to +26

16:10 Screen Size		①	②
		Minimum (Wide) to Maximum (Tele)	Vertical Lens Shift Bottom to Top
120"	258x162	571 to 923	-192 to +31
150"	323x202	715 to 1156	-241 to +39
200"	431x269	957 to 1544	-321 to +51
250"	538x337	1198 to 1932	-401 to +64
280"	603x377	1342 to 2165	-449 to +72

ELPLM10/ELPLM06

Unit: cm

4:3 Screen Size		①	②
		Minimum (Wide) to Maximum (Tele)	Vertical Lens Shift Bottom to Top
50"	102x76	338 to 519	-82 to +6
60"	122x91	409 to 625	-98 to +7
80"	163x122	549 to 838	-131 to +9
100"	203x152	690 to 1051	-164 to +12
120"	244x183	831 to 1264	-197 to +14
150"	305x229	1041 to 1583	-246 to +17
200"	406x305	1393 to 2115	-328 to +23
250"	508x381	1744 to 2647	-410 to +29
300"	610x457	2096 to 3179	-492 to +35



Unit: cm

16:9 Screen Size		①	②
		Minimum (Wide) to Maximum (Tele)	Vertical Lens Shift Bottom to Top
46"	102x57	339 to 520	-73 to +15
50"	111x62	370 to 567	-79 to +17
60"	133x75	446 to 682	-95 to +20
80"	177x100	600 to 914	-126 to +27
100"	221x125	753 to 1146	-158 to +33
120"	266x149	906 to 1378	-189 to +40
150"	332x187	1136 to 1726	-237 to +50
200"	443x249	1519 to 2305	-316 to +67
250"	553x311	1902 to 2885	-395 to +83
275"	609x342	2093 to 3175	-434 to +92

Unit: cm

16:10 Screen Size		①	②
		Minimum (Wide) to Maximum (Tele)	Vertical Lens Shift Bottom to Top
48"	103x65	345 to 528	-77 to +12
50"	108x67	360 to 551	-80 to +13
60"	130x81	434 to 664	-96 to +15
80"	172x108	583 to 889	-128 to +21
100"	215x135	732 to 1115	-160 to +26
120"	258x162	881 to 1340	-192 to +31
150"	323x202	1105 to 1679	-241 to +39
200"	431x269	1477 to 2243	-321 to +51
250"	538x337	1850 to 2807	-401 to +64

16:10 Screen Size		①	②
		Minimum (Wide) to Maximum (Tele)	Vertical Lens Shift Bottom to Top
280"	603x377	2073 to 3145	-449 to +72

ELPLM11/ELPLM07

Unit: cm

4:3 Screen Size		①	②
		Minimum (Wide) to Maximum (Tele)	Vertical Lens Shift Bottom to Top
50"	102x76	492 to 755	-82 to +6
60"	122x91	595 to 910	-98 to +7
80"	163x122	801 to 1221	-131 to +9
100"	203x152	1007 to 1533	-164 to +12
120"	244x183	1213 to 1844	-197 to +14
150"	305x229	1523 to 2311	-246 to +17
200"	406x305	2038 to 3089	-328 to +23
250"	508x381	2554 to 3867	-410 to +29
300"	610x457	3069 to 4645	-492 to +35

Unit: cm

16:9 Screen Size		①	②
		Minimum (Wide) to Maximum (Tele)	Vertical Lens Shift Bottom to Top
46"	102x57	493 to 756	-73 to +15
50"	111x62	538 to 824	-79 to +17
60"	133x75	650 to 994	-95 to +20
80"	177x100	875 to 1333	-126 to +27

16:9 Screen Size		①	②
		Minimum (Wide) to Maximum (Tele)	Vertical Lens Shift Bottom to Top
100"	221x125	1100 to 1672	-158 to +33
120"	266x149	1324 to 2011	-189 to +40
150"	332x187	1661 to 2519	-237 to +50
200"	443x249	2223 to 3367	-316 to +67
250"	553x311	2784 to 4215	-395 to +83
275"	609x342	3065 to 4638	-434 to +92

Unit: cm

16:10 Screen Size		①	②
		Minimum (Wide) to Maximum (Tele)	Vertical Lens Shift Bottom to Top
48"	103x65	501 to 768	-77 to +12
50"	108x67	523 to 801	-80 to +13
60"	130x81	632 to 966	-96 to +15
80"	172x108	851 to 1296	-128 to +21
100"	215x135	1069 to 1626	-160 to +26
120"	258x162	1288 to 1956	-192 to +31
150"	323x202	1616 to 2451	-241 to +39
200"	431x269	2162 to 3275	-321 to +51
250"	538x337	2708 to 4100	-401 to +64
280"	603x377	3036 to 4595	-449 to +72

ELPLL08/ELPLL07

Unit: cm

4:3 Screen Size		①	②
		Minimum (Wide) to Maximum (Tele)	Vertical Lens Shift Bottom to Top
50"	102x76	732 to 1034	-82 to +6
60"	122x91	885 to 1247	-98 to +7
80"	163x122	1191 to 1674	-131 to +9
100"	203x152	1497 to 2100	-164 to +12
120"	244x183	1802 to 2527	-197 to +14
150"	305x229	2261 to 3166	-246 to +17
200"	406x305	3025 to 4232	-328 to +23
250"	508x381	3790 to 5298	-410 to +29
300"	610x457	4554 to 6364	-492 to +35

Unit: cm

16:9 Screen Size		①	②
		Minimum (Wide) to Maximum (Tele)	Vertical Lens Shift Bottom to Top
46"	102x57	734 to 1037	-73 to +15
50"	111x62	801 to 1130	-79 to +17
60"	133x75	967 to 1362	-95 to +20
80"	177x100	1300 to 1826	-126 to +27
100"	221x125	1633 to 2291	-158 to +33
120"	266x149	1967 to 2755	-189 to +40
150"	332x187	2466 to 3452	-237 to +50
200"	443x249	3299 to 4613	-316 to +67
250"	553x311	4132 to 5775	-395 to +83



16:9 Screen Size		①	②
		Minimum (Wide) to Maximum (Tele)	Vertical Lens Shift Bottom to Top
275"	609x342	4548 to 6355	-434 to +92

Unit: cm

16:10 Screen Size		①	②
		Minimum (Wide) to Maximum (Tele)	Vertical Lens Shift Bottom to Top
48"	103x65	746 to 1053	-77 to +12
50"	108x67	778 to 1098	-80 to +13
60"	130x81	940 to 1324	-96 to +15
80"	172x108	1264 to 1776	-128 to +21
100"	215x135	1588 to 2228	-160 to +26
120"	258x162	1913 to 2680	-192 to +31
150"	323x202	2399 to 3358	-241 to +39
200"	431x269	3209 to 4488	-321 to +51
250"	538x337	4019 to 5618	-401 to +64
280"	603x377	4505 to 6296	-449 to +72

ELPLR04

Lens shift is not supported.

Unit: cm

4:3 Screen Size		①	②
50"	102x76	96	-36
60"	122x91	116	-46
80"	163x122	157	-61

4:3 Screen Size		①	②
100"	203x152	198	-76
120"	244x183	239	-91
150"	305x229	300	-114
200"	406x305	402	-152
250"	508x381	504	-191
300"	610x457	606	-229

Unit: cm

16:9 Screen Size		①	②
46"	102x57	96	-28
50"	111x62	105	-31
60"	133x75	127	-37
80"	177x100	172	-50
100"	221x125	216	-62
120"	266x149	261	-75
150"	332x187	327	-93
200"	443x249	439	-125
250"	553x311	550	-156
275"	610x345	605	-172

Unit: cm

16:10 Screen Size		①	②
48"	103x65	98	-32
50"	108x67	102	-33
60"	130x81	124	-40
80"	172x108	167	-54
100"	215x135	210	-67

16:10 Screen Size		①	②
120"	258x162	254	-81
150"	323x202	318	-101
200"	431x269	427	-135
250"	538x337	535	-168
280"	603x377	600	-188

Lens type	①	
	②	③
ELPLS04	180	240
ELPLW04	120	170
ELPLM06	260	340

Polarizer (ELPPL01) Installation Distance

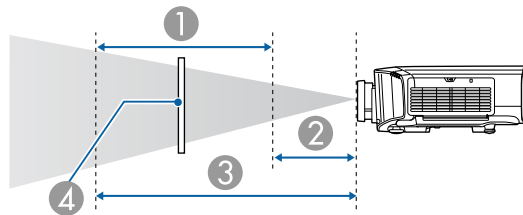

- ① Possible installation range of the polarizer
- ② Shortest distance from the projection lens to the polarizer
- ③ Longest distance from the projection lens to the polarizer
- ④ Polarizer (ELPPL01)

EB-G7905U/EB-G7900U/EB-G7500U/EB-G7400U

Units: mm

Lens type	①	
	②	③
ELPLM08	140	170
ELPLW06	120	170
ELPLM09	180	240
ELPLM10	260	340

EB-G7200W/EB-G7000W

Units: mm

Lens type	①	
	②	③
ELPLM08	150	170
ELPLW06	120	170
ELPLM09	200	240
ELPLM10	300	340
ELPLS04	200	240
ELPLW04	120	170
ELPLM06	300	340

EB-G7805/EB-G7800/EB-G7100

Units: mm

Lens type	①	
	②	③
ELPLM08	130	170
ELPLW06	120	170
ELPLM09	170	240
ELPLM10	230	340
ELPLS04	170	240



Lens type	①	
	②	③
ELPLW04	120	170
ELPLM06	230	340

Supported Resolutions

When the resolution of the input signals is larger than the projector's panel resolution, the image quality may decline.

Computer signals (analog RGB)

Signal	Refresh Rate (Hz)	Resolution (Dots)
VGA	60/72/75/85	640x480
SVGA	60/72/75/85	800x600
XGA	60/70/75/85	1024x768
WXGA	60	1280x768
	60	1366x768
	60/75/85	1280x800
WXGA+	60/75/85	1440x900
WXGA++	60	1600x900
SXGA	70/75/85	1152x864
	60/75/85	1280x1024
	60/75/85	1280x960
SXGA+	60/75	1400x1050
WSXGA+*1	60	1680x1050
UXGA	60	1600x1200
WUXGA*2	60	1920x1200

*1 EB-G7900U/EB-G7400U/EB-G7200W/EB-G7000W only. Only compatible when **Wide** is selected as the **Resolution** from the Configuration menu.

*2 EB-G7900U/EB-G7400U only. Only compatible when VESA CVT-RB (Reduced Blanking) signal is input.

Even when signals other than those mentioned above are input, it is likely that the image can be projected. However, not all functions may be supported.

Component Video

Signal	Refresh Rate (Hz)	Resolution (Dots)
SDTV (480i)	60	720x480
SDTV (576i)	50	720x576
SDTV (480p)	60	720x480
SDTV (576p)	50	720x576
HDTV (720p)	50/60	1280x720
HDTV (1080i)	50/60	1920x1080
HDTV (1080p)*	50/60	1920x1080

* Only for the input signals from the Computer port.

Input signal from the DVI-D port, HDMI port, and HDBaseT port

Signal	Refresh Rate (Hz)	Resolution (Dots)
VGA	60	640x480
SVGA	60	800x600
XGA	60	1024x768
WXGA	60	1280x800
	60	1366x768
WXGA+	60	1440x900
WXGA++	60	1600x900
WSXGA+*1	60	1680x1050
	60	1280x960
SXGA	60	1280x1024
	60	1400x1050
SXGA+	60	1400x1050
UXGA	60	1600x1200
WUXGA*2	60	1920x1200

Signal	Refresh Rate (Hz)	Resolution (Dots)
QXGA*3	60	2048x1536
WQHD*3	60	2560x1440
WQXGA*2 *3	60	2560x1600
SDTV (480i/480p)	60	720x480
SDTV (576i/576p)	50	720x576
HDTV (720p)	50/60	1280x720
HDTV (1080i)	50/60	1920x1080
HDTV (1080p)	24/30/50/60	1920x1080
4Kx2K*3	24/25/30/50/60	3840x2160
4Kx2K (SMPTE)*3	24/50/60	4096x2160

*1 EB-G7900U/EB-G7400U/EB-G7200W/EB-G7000W only.

*2 Only compatible when VESA CVT-RB (Reduced Blanking) signal is input.

*3 EB-G7900U/EB-G7400U only. Only for the input signals from the HDMI port and HDBaseT port.

Projector General Specifications

Product name	EB-G7900U	EB-G7400U	EB-G7200W	EB-G7000W	EB-G7800
Dimensions	525 (W) x 164 (H) x 425 (D) mm (not including raised section)				
LCD panel size	0.76" Wide				0.79"
Display method	Polysilicon TFT active matrix				
Resolution	2,304,000 pixels WUXGA (1920 (W) x 1200 (H) dots) x 3		1,024,000 pixels WXGA (1280 (W) x 800 (H) dots) x 3		786,432 pixels XGA (1024 (W) x 768 (H) dots) x 3
Focus adjustment	Automatic				
Zoom adjustment*1	Automatic (1.6x)				
Lens shift*2	Automatic (Maximum vertical direction of approx. 67%, Maximum horizontal direction of approx. 30%)*3				Automatic (Maximum vertical direction of approx. 57%, Maximum horizontal direction of approx. 30%)*4
Lamp	UHE lamp, 400 W Model No.: ELPLP93				
Lamp operating life	About 3,000 hours (Normal, Power Consumption: Off) About 4,000 hours (Normal, Power Consumption: On) About 2,000 hours (Portrait Mode)	About 4,000 hours (Normal) About 2,000 hours (Portrait Mode)	About 3,000 hours (Normal, Power Consumption: Off) About 4,000 hours (Normal, Power Consumption: On) About 2,000 hours (Portrait Mode)		
Max. audio output	10 W monaural				
Speaker	1				
Power supply	100-240V AC±10% 50/60Hz 6.0-2.6A	100-240V AC±10% 50/60Hz Hz 5.0-2.2A	100-240V AC±10% 50/60Hz 6.0-2.6A	100-240V AC±10% 50/60Hz 5.5-2.4A	100-240V AC±10% 50/60Hz 6.0-2.6A

Power consumption	100 to 120 V area	Rated power consumption: 601 W Standby power consumption (Communication On): 2.2 W Standby power consumption (Communication Off): 0.22 W	Rated power consumption: 498 W Standby power consumption (Communication On): 2.2 W Standby power consumption (Communication Off): 0.22 W	Rated power consumption: 601 W Standby power consumption (Communication On): 2.2 W Standby power consumption (Communication Off): 0.22 W	Rated power consumption: 540 W Standby power consumption (Communication On): 2.2 W Standby power consumption (Communication Off): 0.22 W	Rated power consumption: 601 W Standby power consumption (Communication On): 2.2 W Standby power consumption (Communication Off): 0.22 W
	220 to 240 V area	Rated power consumption: 572 W Standby power consumption (Communication On): 2.3 W Standby power consumption (Communication Off): 0.30 W	Rated power consumption: 477 W Standby power consumption (Communication On): 2.3 W Standby power consumption (Communication Off): 0.30 W	Rated power consumption: 572 W Standby power consumption (Communication On): 2.3 W Standby power consumption (Communication Off): 0.30 W	Rated power consumption: 515 W Standby power consumption (Communication On): 2.3 W Standby power consumption (Communication Off): 0.30 W	Rated power consumption: 572 W Standby power consumption (Communication On): 2.3 W Standby power consumption (Communication Off): 0.30 W
Operating altitude	Altitude 0 to 5,000 m					
Operating temperature*5	0 to +45°C (Altitude of 0 to 1,500 m, no condensation) 0 to +40°C (Altitude of 1,501 to 3,048 m, no condensation) 0 to +35°C (Altitude of 3,049 to 5,000 m, no condensation)					
Storage temperature	-10 to +60°C (No condensation)					
Mass*1	Approx. 12.9 kg					

*1 The specifications are when ELPLM08 is attached.

*2 ELPLR04 does not support lens shift.

*3 ELPLX01 has a maximum upward direction of approx. 17% and a maximum horizontal direction of approx. 10%.

*4 ELPLX01 has a maximum upward direction of approx. 7% and a maximum horizontal direction of approx. 8%.

*5 If the surrounding temperature gets too high, the lamp automatically dims (except for EB-G7400U. About 40°C at an altitude of 0 to 1500 m, 35°C at an altitude of 1501 to 3048 m, and 30°C at an altitude of 3049 to 5000 m).

Product name			EB-G7900U	EB-G7400U	EB-G7200W	EB-G7000W	EB-G7800
Connectors	Computer Port	1	Mini D-Sub15-pin (female) blue				
	Audio1 port	1	Stereo mini jack (3.5Φ)				
	BNC port	1	5BNC (female)				
	Audio2 port	1	Stereo mini jack (3.5Φ)				
	DVI-D port	1	DVI-D 24 pin Single link HDCP supported				
	HDMI port	1	HDMI HDCP*1 supported (Audio is only supported by PCM)		HDMI HDCP supported (Audio is only supported by PCM)		
	Audio3 port	1	Stereo mini jack (3.5Φ)				
	Audio Out port	1	Stereo mini jack (3.5Φ)				
	Monitor Out port	1	Mini D-Sub15-pin (female) black				
	HDBaseT port	1	RJ-45*1		RJ-45		
	LAN port	1	RJ-45				
	Service port*2	1	USB connector (Type B)				
	RS-232C port	1	Mini D-Sub 9-pin (male)				
	Remote port	1	Stereo mini jack (3.5Φ)				
USB port (Only for Wireless LAN unit)*2	1	USB connector (Type A)					

*1 Supports HDCP 2.2.

*2 Supports USB 2.0. However, USB ports are not guaranteed to operate all devices that support USB.

This product is also designed for IT power distribution system with phase-to-phase voltage 230V.

DECLARATION of CONFORMITY

According to 47CFR, Part 2 and 15

Class B Personal Computers and Peripherals; and/or
CPU Boards and Power Supplies used with Class B Personal Computers

We: Epson America, Inc.
Located at: 3840 Kilroy Airport Way
MS: 3-13
Long Beach, CA 90806
Tel: 562-981-3840

Declare under sole responsibility that the product identified herein, complies with 47CFR Part 2 and 15 of the FCC rules as a Class B digital device. Each product marketed, is identical to the representative unit tested and found to be compliant with the standards. Records maintained continue to reflect the equipment being produced can be expected to be within the variation accepted, due to quantity production and testing on a statistical basis as required by 47CFR 2.909. Operation is subject to the following two conditions : (1) this device may not cause harmful interference, and (2) this device must accept any interference received, including interference that may cause undesired operation.

Trade Name: EPSON
Type of Product: LCD Projector
Model: H749C/H750C/H751C/H752C/H753C/H754C/
H762C

**FCC Compliance Statement
For United States Users**

This equipment has been tested and found to comply with the limits for a Class B digital device, pursuant to Part 15 of the FCC Rules. These limits are designed to provide reasonable protection against harmful interference in a residential installation. This equipment generates, uses, and can radiate radio frequency energy and, if not installed and used in accordance with the instructions, may cause harmful interference to radio communications. However, there is no guarantee that interference will not occur in a particular installation. If this equipment does cause interference to radio or television reception, which can be determined by turning the equipment off and on, the user is encouraged to try to correct the interference by one or more of the following measures.

- Reorient or relocate the receiving antenna.
- Increase the separation between the equipment and receiver.
- Connect the equipment into an outlet on a circuit different from that to which the receiver is connected.
- Consult the dealer or an experienced radio/TV technician for help.

WARNING

The connection of a non-shielded equipment interface cable to this equipment will invalidate the FCC Certification or Declaration of this device and may cause interference levels which exceed the limits established by the FCC for this equipment. It is the responsibility of the user to obtain and use a shielded equipment interface cable with this device. If this equipment has more than one interface connector, do not leave cables connected to unused interfaces. Changes or modifications not expressly approved by the manufacturer could void the user's authority to operate the equipment.

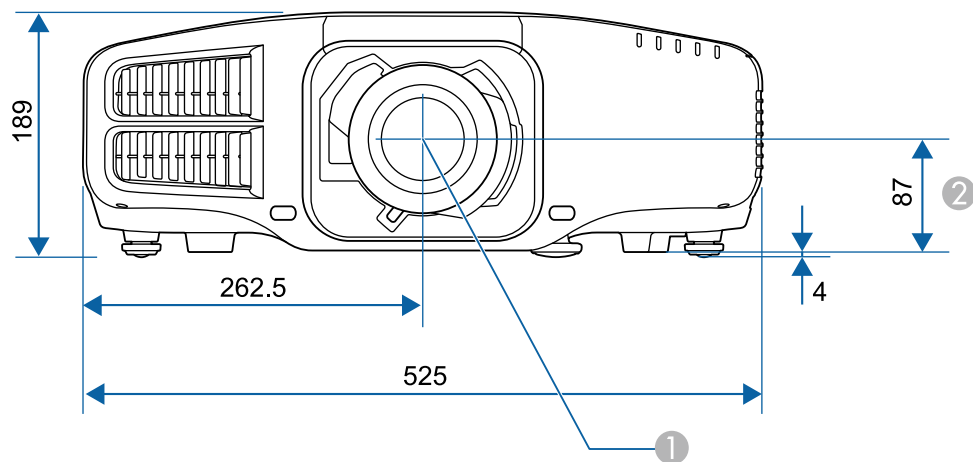

- ① Center of lens
- ② Distance from center of lens to suspension bracket fixing point

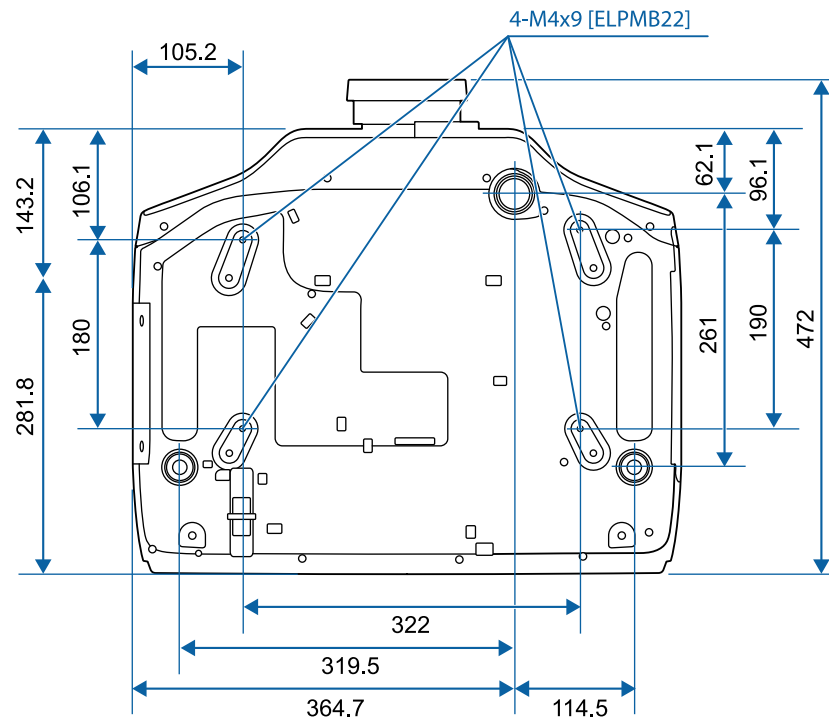

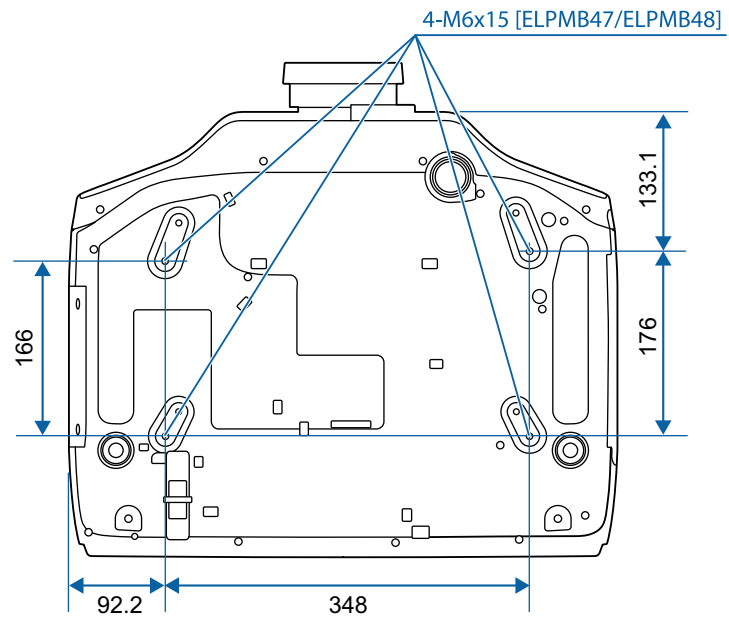

Units: mm

This section briefly explains the difficult terms that are not explained in the text of this guide. For details, refer to other commercially available publications.

AMX Device Discovery	AMX Device Discovery is a technology developed by AMX to facilitate AMX control systems for easy operation of the target equipment. Epson have implemented this protocol technology, and have provided a setting to enable the protocol function (ON). See the AMX Web site for more details. URL: http://www.amx.com/
Aspect Ratio	The ratio between an image's length and its height. Screens with a horizontal:vertical ratio of 16:9, such as HDTV screens, are known as wide screens. SDTV and general computer displays have an aspect ratio of 4:3.
Component Video	A method that separates the video signal into a luminance component (Y), and a blue minus luminance (Cb or Pb) and a red minus luminance (Cr or Pr).
Composite video	A method that combines the video signal into a luminance component and a color component for transmission down a single cable.
Contrast	The relative brightness of the light and dark areas of an image can be increased or decreased to make text and graphics stand out more clearly, or to make them appear softer. Adjusting this particular property of an image is called contrast adjustment.
Control4 Simple Device Discovery Protocol (SDDP)	Control4 SDDP is a technology developed by Control4 to allow Control4 control systems to acquire device information for the projector. Epson have implemented this protocol technology, and have provided a setting to enable the protocol function (ON). See the Control4 Web site for more details. URL: http://www.control4.com/
DHCP	An abbreviation of Dynamic Host Configuration Protocol, this protocol automatically assigns an IP Address to equipment connected to a network.
DICOM	An acronym for Digital Imaging and Communications in Medicine. An international standard that defines image standards and a communications protocol for medical images.
Gateway Address	This is a server (router) for communicating across a network (subnet) divided according to Subnet Mask .
HDBaseT	The connection standard for consumer electronics determined by the HDBaseT Alliance. Communicates various control signals such as uncompressed HD video, audio and 100BASE-TX Ethernet using a LAN cable.
HDCP	HDCP is an abbreviation for High-bandwidth Digital Content Protection. It is used to prevent illegal copying and protect copyrights by encrypting digital signals sent over DVI and HDMI ports. HDCP2.2 is a copyright protection standard for 4K content.
HDTV	An abbreviation for High-Definition Television that refers to high-definition systems which satisfy the following conditions. <ul style="list-style-type: none"> • Vertical resolution of 720p or 1080i or greater (p = Progressive, i = Interlace) • Screen Aspect Ratio of 16:9
Infrastructure mode	A method for wireless LAN connection in which devices communicate through access points.
Interlace	Transmits information needed to create one screen by sending every other line, starting from the top of the image and working down to the bottom. Images are more likely to flicker because one frame is displayed every other line.

IP Address	A number to identify a computer connected to a network.
Progressive	Projects information to create one screen at a time, displaying the image for one frame. Even though the number of scan lines is the same, the amount of flicker in images decreases because the volume of information has doubled compared with an interlace system.
Refresh Rate	The light-emitting element of a display maintains the same luminosity and color for an extremely short time. Because of this, the image must be scanned many times per second to refresh the light-emitting element. The number of refresh operations per second is called the Refresh rate and is expressed in hertz (Hz).
SDTV	An abbreviation for Standard Definition Television that refers to standard television systems which do not satisfy the conditions for HDTV ▶ High-Definition Television.
SNMP	An abbreviation for Simple Network Management Protocol, which is the protocol for monitoring and controlling devices such as routers and computers connected to a TCP/IP network.
sRGB	An international standard for color intervals that was formulated so that colors that are reproduced by video equipment can be handled easily by computer operating systems (OS) and the Internet. If the connected source has an sRGB mode, set both the projector and the connected signal source to sRGB.
Subnet Mask	This is a numerical value that defines the number of bits used for the network address on a divided network (subnet) from the IP address.
Sync.	The signals output from computers have a specific frequency. If the projector frequency does not match this frequency, the resulting images are not of a good quality. The process of matching the phases of these signals (the relative position of the crests and the troughs in the signal) is called Synchronization. If the signals are not synchronized, flickering, blurriness, and horizontal interference occur.
Tracking	The signals output from computers have a specific frequency. If the projector frequency does not match this frequency, the resulting images are not of a good quality. The process of matching the frequency of these signals (the number of crests in the signal) is called Tracking. If Tracking is not carried out correctly, wide vertical stripes appear in the signal.
Trap IP Address	This is the IP Address ▶ for the destination computer used for error notification in SNMP.

All rights reserved. No part of this publication may be reproduced, stored in a retrieval system, or transmitted in any form or by any means, electronic, mechanical, photocopying, recording, or otherwise, without the prior written permission of Seiko Epson Corporation. No patent liability is assumed with respect to the use of the information contained herein. Neither is any liability assumed for damages resulting from the use of the information contained herein.

Neither Seiko Epson Corporation nor its affiliates shall be liable to the purchaser of this product or third parties for damages, losses, costs, or expenses incurred by the purchaser or third parties as a result of: accident, misuse, or abuse of this product or unauthorized modifications, repairs, or alterations to this product, or (excluding the U.S.) failure to strictly comply with Seiko Epson Corporation's operating and maintenance instructions.

Seiko Epson Corporation shall not be liable against any damages or problems arising from the use of any options or any consumable products other than those designated as Original Epson Products or Epson Approved Products by Seiko Epson Corporation.

The contents of this guide may be changed or updated without further notice.

Illustrations in this guide and the actual projector may differ.

Restriction of Use

When this product is used for applications requiring high reliability/safety such as transportation devices related to aviation, rail, marine, automotive etc.; disaster prevention devices; various safety devices etc; or functional/precision devices etc, you should use this product only after giving consideration to including fail-safes and redundancies into your design to maintain safety and total system reliability. Because this product was not intended for use in applications requiring extremely high reliability/safety such as aerospace equipment, main communication equipment, nuclear power control equipment, or medical equipment related to direct medical care etc, please make your own judgment on this product's suitability after a full evaluation.

About Notations

Microsoft® Windows® 2000 operating system
Microsoft® Windows® XP operating system
Microsoft® Windows Vista® operating system
Microsoft® Windows® 7 operating system
Microsoft® Windows® 8 operating system
Microsoft® Windows® 8.1 operating system
Microsoft® Windows® 10 operating system

In this guide, the operating systems above are referred to as "Windows 2000", "Windows XP", "Windows Vista", "Windows 7", "Windows 8", "Windows 8.1", and "Windows 10". Furthermore, these may be referred to as the collective term Windows, and multiple versions of Windows may be referred to as, for example, Windows 2000/XP/Vista/7/8/8.1/10, with the Windows notation omitted.

Mac OS X 10.3.x
Mac OS X 10.4.x
Mac OS X 10.5.x
Mac OS X 10.6.x
OS X 10.7.x
OS X 10.8.x
OS X 10.9.x
OS X 10.10.x
OS X 10.11.x

In this guide, the operating systems above are referred to as "Mac OS X 10.3.x", "Mac OS X 10.4.x", "Mac OS X 10.5.x", "Mac OS X 10.6.x", "OS X 10.7.x", "OS X 10.8.x", "OS X 10.9.x", "OS X 10.10.x", and "OS X 10.11.x". Furthermore, the collective term "OS X" is used to refer to them all.

Trademarks and Copyrights

EPSON is a registered trademark, EXCEED YOUR VISION, ELPLP and their logos are registered trademarks or trademarks of Seiko Epson Corporation.

Mac, Mac OS, and OS X, are trademarks of Apple Inc.

Microsoft, Windows, Windows Vista, PowerPoint, and Windows logo are trademarks or registered trademarks of Microsoft Corporation in the United States and/or other countries.

HDMI and High-Definition Multimedia Interface are the trademarks or registered trademarks of HDMI Licensing LLC. 

PJLink trademark is a trademark applied for registration or is already registered in Japan, the United States of America and other countries and areas.

WPA™ and WPA2™ are registered trademarks of the Wi-Fi Alliance.

Crestron and Crestron RoomView are registered trademarks of Crestron Electronics, Inc.

"QR Code" is a registered trademark of DENSO WAVE INCORPORATED.

Extron® and XTP® are registered trademarks of Extron Electronics.

HDBaseT™ and the HDBaseT Alliance logo are trademarks of the HDBaseT Alliance.

Other product names used herein are also for identification purposes only and may be trademarks of their respective owners. Epson disclaims any and all rights in those marks.







©SEIKO EPSON CORPORATION 2016. All rights reserved.







Indication of the manufacturer and the importer in accordance with requirements of directive 2011/65/EU (RoHS)

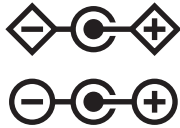

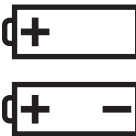





Manufacturer: SEIKO EPSON CORPORATION
Address: 3-5, Owa 3-chome, Suwa-shi, Nagano-ken 392-8502 Japan
Telephone: 81-266-52-3131

Importer: SEIKO EUROPE B.V.
Address: Azië building, Atlas Arena, Hoogoorddreef 5, 1101 BA Amsterdam
Zuidoost The Netherlands
Telephone: 31-20-314-5000

The following table lists the meaning of the safety symbols labeled on the equipment.

No.	Symbol mark	Approved standards	Meaning
①		IEC60417 No. 5007	"ON" (power) To indicate connection to the mains.
②		IEC60417 No. 5008	"OFF" (power) To indicate disconnection from the mains.
③		IEC60417 No. 5009	Stand-by To identify the switch or switch position by means of which part of the equipment is switched on in order to bring it into the stand-by condition.
④		ISO7000 No. 0434B IEC3864-B3.1	Caution To identify general caution when using the product.
⑤		IEC60417 No. 5041	Caution, hot surface To indicate that the marked item can be hot and should not be touched without taking care.
⑥		IEC60417 No. 6042 ISO3864-B3.6	Caution, risk of electric shock To identify equipment that has risk of electric shock.
⑦		IEC60417 No. 5957	For indoor use only To identify electrical equipment designed primarily for indoor use.
⑧		IEC60417 No. 5926	Polarity of d.c. power connector To identify the positive and negative connections (the polarity) on a piece of equipment to which a d.c. power supply may be connected.

No.	Symbol mark	Approved standards	Meaning
⑨		IEC60417 No. 5001B	Battery, general On battery powered equipment. To identify a device for instance a cover for the battery compartment, or the connector terminals.
⑩		IEC60417 No. 5002	Positioning of cell To identify the battery holder itself and to identify the positioning of the cell(s) inside the battery holder.
⑪		IEC60417 No. 5019	Protective earth To identify any terminal which is intended for connection to an external conductor for protection against electric shock in case of a fault, or the terminal of a protective earth electrode.
⑫		IEC60417 No. 5017	Earth To identify an earth (ground) terminal in cases where symbol No. 11 is not explicitly required.
⑬		IEC60417 No. 5032	Alternating current To indicate on the rating plate that the equipment is suitable for alternating current only; to identify relevant terminals.
⑭		IEC60417 No. 5031	Direct current To indicate on the rating plate that the equipment is suitable for direct current only; to identify relevant terminals.
⑮		IEC60417 No. 5172	Class II equipment To identify equipment meeting the safety requirements specified for Class II equipment according to IEC 61140.

No.	Symbol mark	Approved standards	Meaning
16		ISO 3864	General prohibition To identify actions or operations that are prohibited.
17		ISO 3864	Contact prohibition To indicate injury that could occur due to touching a specific part of the equipment.
18		---	Never look into the projection lens while the projector is on.
19		---	To indicate that the marked item don't place anything on projector.
20		ISO3864 IEC60825-1	Caution, laser radiation To indicate the equipment has a laser radiation part.
21		ISO 3864	Disassembly prohibition To indicate a risk of injury, such as electric shock, if the equipment is disassembled.
22		---	Never look into the lens while the LED for lighting is on.
23		IEC60417 No. 5266	Standby, partial standby To indicate that part of the equipment is in the ready status.
24		ISO3864 IEC60417 No. 5057	Caution, movable parts To indicate that you must keep away from movable parts according to protection standards.

A

A/V Mute	18, 117
A/V Settings	143
Air exhaust vent	14
Air Filter Notice	141
Air filter replacement period	195
AMX Device Discovery	151
Aspect	87, 137
Audio Out port	16
Audio1 port	16
Audio2 port	16
Audio3 port	16
Auto Iris	87, 136
Auto Setup	138

B

Basic menu	147
Batch setup function	154
Beep	142
Black Level	145
BNC port	16
BNC Sync Termination	142
Brightness	135
Brightness Level	144

C

Ceiling	141
Ceiling mount fixing points	17
Cinema	86
Cleaning	189
Cleaning the air filter and air intake vent	189

Cleaning the projector's surface	189
Color Adjustment	136
Color adjustment	136
Color Matching	144
Color Mode	86, 135, 144
Color Saturation	135
Color Uniformity	141, 144
Computer port	16
Configuration menu	132
Consumables	216
Contrast	135
Control panel	17
Control4 SDDP	151
Corner Wall	75
Crestron RoomView	151, 210
Cross	119

D

Date & Time	143
DHCP	149, 150
DICOM SIM	86
Direct Power On	142
Direction	141
Display	141
Display Background	141
Distance	217
Document Camera	215
DVI-D port	16
Dynamic	86

E

EasyMP Monitor	202
Edge Blending	101, 144

Epson Web Control	202
Esc	18
ESC/VP21	208
Event ID	153
Extended menu	140
Extron XTP	144
E-Zoom	118

F

Filter Indicator	164
Filter indicator	164
Focus	37
Freeze	118
Front	141
Front adjustable foot	17
Full Lock	128

G

Gateway Address	149, 150
Geometric Correction	139

H

H/V-Keystone	139
HDBaseT	144
HDBaseT port	16
HDBaseT Signal Quality	153
HDMI port	16
Help function	162
High Altitude Mode	142
Home screen	57
How to replace the air filter	195
How to replace the lamp	192

I

Image menu	135
Indicators	164
Info menu	152
Input Signal	152
Installation requirements	28
Installation settings	28
IP Address	149, 150

L

Lamp cover	15
Lamp indicator	164
Lamp replacement period	192
Language	145
Lens Operation Lock	129
Lens Replacement Cover	26
Lens shift	33

M

Mail Notification	150, 207
Memory	139
Menu	17
Message Broadcasting	152, 202
Messages	141
Monitor displays	237
Monitor Out port	16
Multi-Projection	86, 144
Multi-Projection function	101

N

Network Configuration	146
Network information	146

Network menu	145
Notification email address 1/2/3	151

O

Operating temperature	240
Operation	142
Optional accessories	215
Overheating	166
Overscan	138

P

Panel Alignment	141
Part names and functions	14
Password protect	126
PJLink	210
PJLink Password	147
Port Number	151
Position	138
Power indicator	164
Power inlet	15
Power On Protection	126
Presentation	86
Priority Gateway	151
Projection	141
Projection lens	26
Projector	56, 58
Projector ID	41
Projector keyword	147
Projector Name	147

Q

Quick Corner	139
Quick Wireless Connection USB Key	53

R

Reading mail	207
Rear	141
Rear feet	17
Refresh Rate	152
Remote control	19
Remote control button lock	129
Remote control ID	42
Remote port	16
Remote receiver	14
Replacing batteries	22
Reset All	153
Reset Memory	153
Reset menu	153
Resetting the lamp operating time	153, 195
Resolution	137, 152
RGBCMY	144
RoomView	211
RS-232C port	16

S

Scale	138, 144
Schedule	123
Schedule Settings	145
Screen	141
Screen settings	30
Screen Size	116
Screen size	217
Search Access Point	149
Serial Number	153
Settings menu	138
Sharpness	136

Signal menu	137
SMTP Server	150
SNMP	208
Soft keyboard	146
Source	115, 152
Source Search	17, 59
Specifications	239
Split Screen	139
Split Screen Setup	115
sRGB	86
Standby Mode	143
Startup Screen	141
Status	153
Status indicators	14
Storage temperature	240
Subnet Mask	149, 150
Supported monitor displays	237
Swap Screens	116
Sync Info	152
Sync.	138

T

Temp indicator	164
Test Pattern	32, 139
Tint	135
Tracking	137
Trap IP Address 1/2	151

U

User Button	139
User's Logo	119
User's Logo Protection	126

V

Volume	139
--------------	-----

W

Web browser	202
Web Control Password	147
White Balance	136
Wired LAN menu	150
Wireless LAN menu	147